

Power cable - SAC-5P-M12MRL/10,0-280 FE - 1414862

Please be informed that the data shown in this PDF Document is generated from our Online Catalog. Please find the complete data in the user's documentation. Our General Terms of Use for Downloads are valid (<http://phoenixcontact.com/download>)



Power cable, 5-position, PUR halogen-free, gray RAL 7001, Plug angled M12, coding: L, on free cable end, cable length: 10 m, for direct current up to 16 A/63 V

Your advantages

- ✓ Easy and safe: 100% electrically tested plug-in components
- ✓ High-performance: DC connectors for up to 16 A and 63 V DC
- ✓ Protection against mismatching, thanks to special L-coding
- ✓ Our standard: robust halogen-free PUR cable



Key Commercial Data

Packing unit	1 pc
GTIN	 4 055626 034942
GTIN	4055626034942

Technical data

Dimensions

Length of cable	10 m
-----------------	------

Ambient conditions

Ambient temperature (operation)	-25 °C ... 85 °C (Plug / socket)
Degree of protection	IP65
	IP67

General

Rated current at 40°C	16 A
Rated voltage	63 V DC
Number of positions	5
Color handle area	black
Insulation resistance	≥ 100 MΩ

Power cable - SAC-5P-M12MRL/10,0-280 FE - 1414862

Technical data

General

Coding	L - Power
Standards/regulations	M12 connector IEC 61076-2-111
Status display	No
Protective circuit/component	unwired
Overvoltage category	III
Degree of pollution	3
Torque	0.4 Nm (M12 connector)

Material

Flammability rating according to UL 94	V0
Contact material	CuZn
Contact surface material	Ni/Au
Contact carrier material	PA
Material of grip body	PP
Material, knurls	Zinc die-cast, nickel-plated

Standards and Regulations

Standards/specifications	M12 connector IEC 61076-2-111
Flammability rating according to UL 94	V0

Cable

Cable type	PUR halogen-free gray
Cable type (abbreviation)	280
UL AWM style	20233 / 10493 (80°C/300 V)
Conductor cross section	5x 2.5 mm ²
AWG power supply	14
Conductor structure, voltage supply	141x 0.15 mm
Core diameter including insulation	2.85 mm ±0.1 mm
Thickness, insulation	≥ 0.31 mm
Wire colors	Brown, white, blue, black, gray
External sheath, color	gray RAL 7001
Outer sheath thickness	approx. 0.76 mm
External cable diameter D	9.65 mm ±0.25 mm
Minimum bending radius, fixed installation	5 x D
Minimum bending radius, flexible installation	10 x D
Number of bending cycles	4000000
Minimum bending radius, drag chain applications	10 x D
Traversing path	10 m
Traversing rate	3 m/s
Acceleration	10 m/s ²
Cable weight	185 kg/km
Outer sheath, material	PUR

Power cable - SAC-5P-M12MRL/10,0-280 FE - 1414862

Technical data

Cable

Material conductor insulation	PP
Conductor material	Bare Cu litz wires
Insulation resistance	$\geq 1 \text{ G}\Omega \cdot \text{km}$ (at 20 °C)
Conductor resistance	$\leq 8 \text{ }\Omega/\text{km}$ (at 20 °C)
Nominal voltage, cable	$\leq 300 \text{ V AC}$
Test voltage, cable	$\geq 3000 \text{ V AC}$ (Spark test)
Flame resistance	According to UL 758/1581 (Cable Flame)
	according to UL 758/1581 FT1
	According to DIN EN 60332-1-2
Halogen-free	in accordance with DIN VDE 0472 part 815
	in accordance with DIN EN 50267-2-1
Resistance to oil	according to DIN EN 60811-404, 168 h at 100 °C
Other resistance	Hydrolysis and microbe resistant as per VDE 0282 section 10
	Low adhesion
	abrasion-resistant
	Resistant to salt water
Ambient temperature (operation)	-50 °C ... 80 °C (cable, fixed installation)
	-30 °C ... 80 °C (cable, flexible installation)

Environmental Product Compliance

REACH SVHC	Lead 7439-92-1
China RoHS	Environmentally Friendly Use Period = 50 years
	For details about hazardous substances go to tab "Downloads", Category "Manufacturer's declaration"

Drawings

Power cable - SAC-5P-M12MRL/10,0-280 FE - 1414862

Dimensional drawing

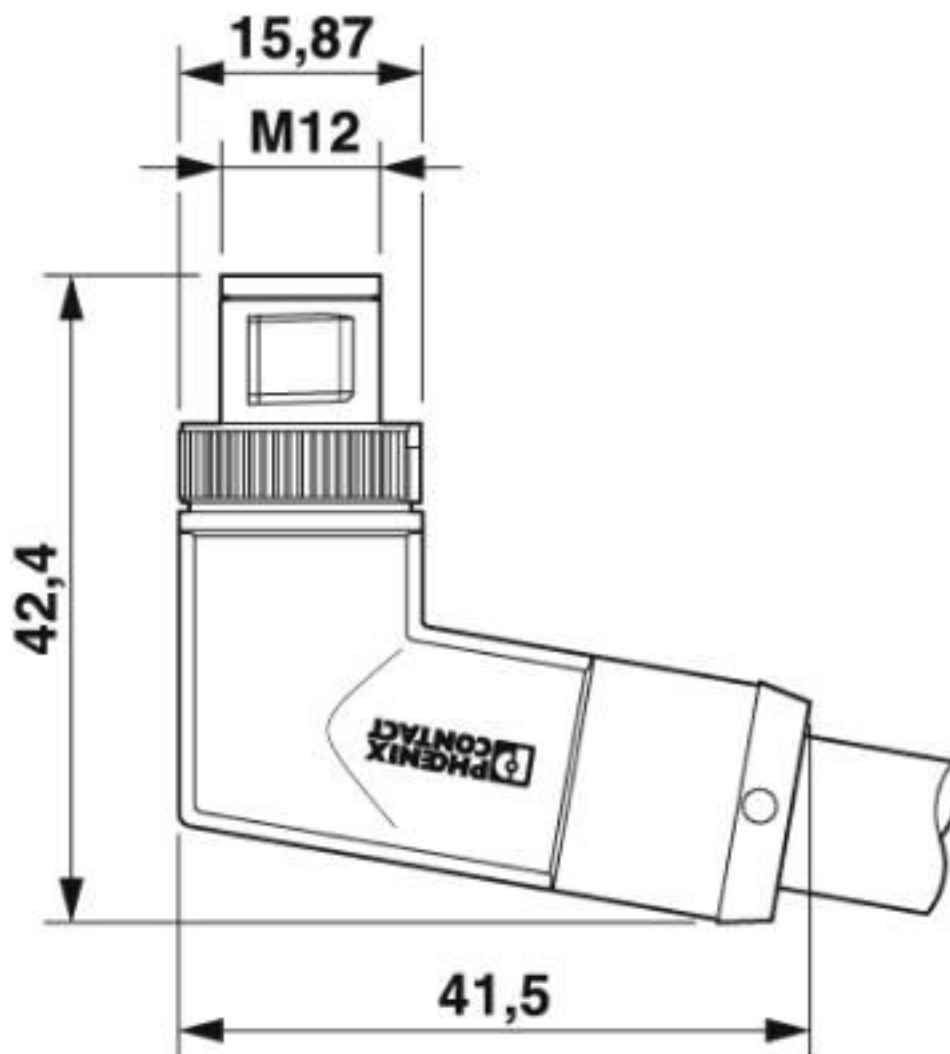

M12 x 1 male plug, angled

Power cable - SAC-5P-M12MRL/10,0-280 FE - 1414862

Schematic diagram

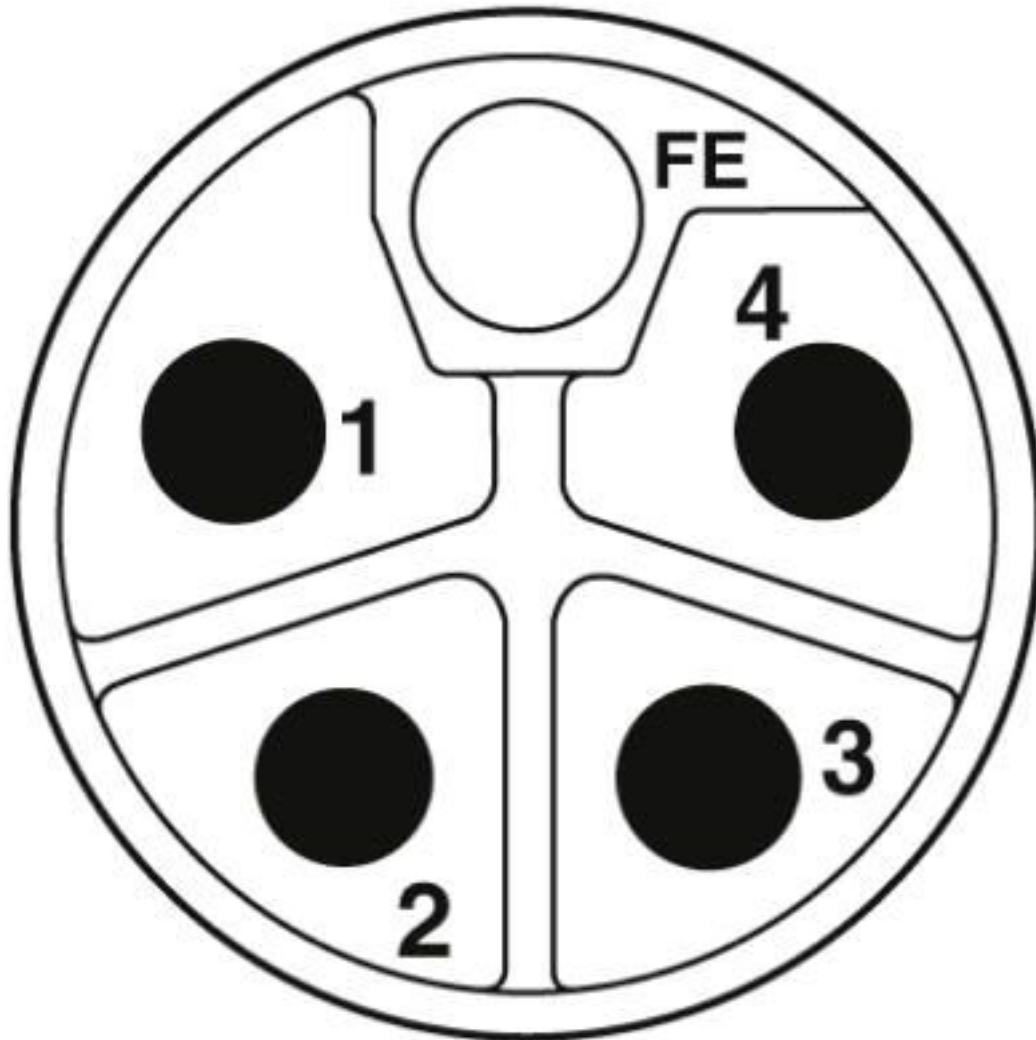

Pin assignment of M12 connector, 5-pos., L-coded, pin side view

Power cable - SAC-5P-M12MRL/10,0-280 FE - 1414862

Diagram

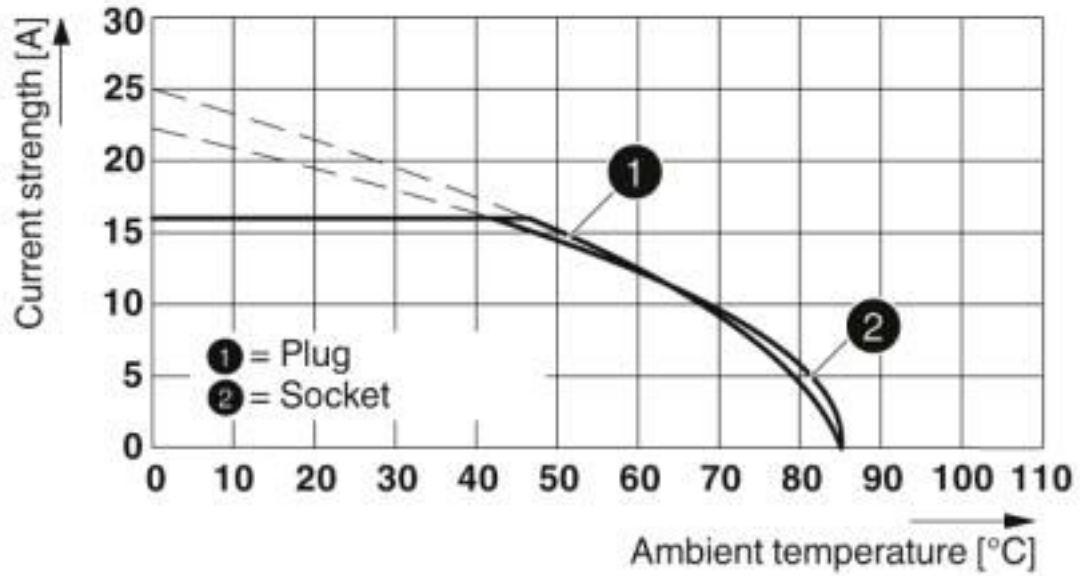

Circuit diagram

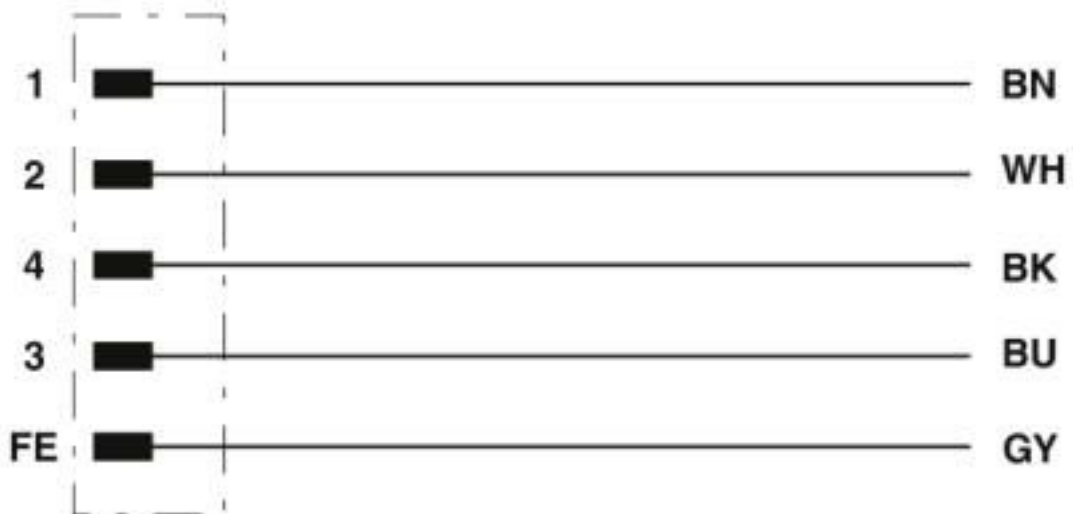

Contact assignment of the M12 plug

Power cable - SAC-5P-M12MRL/10,0-280 FE - 1414862

Cable cross section

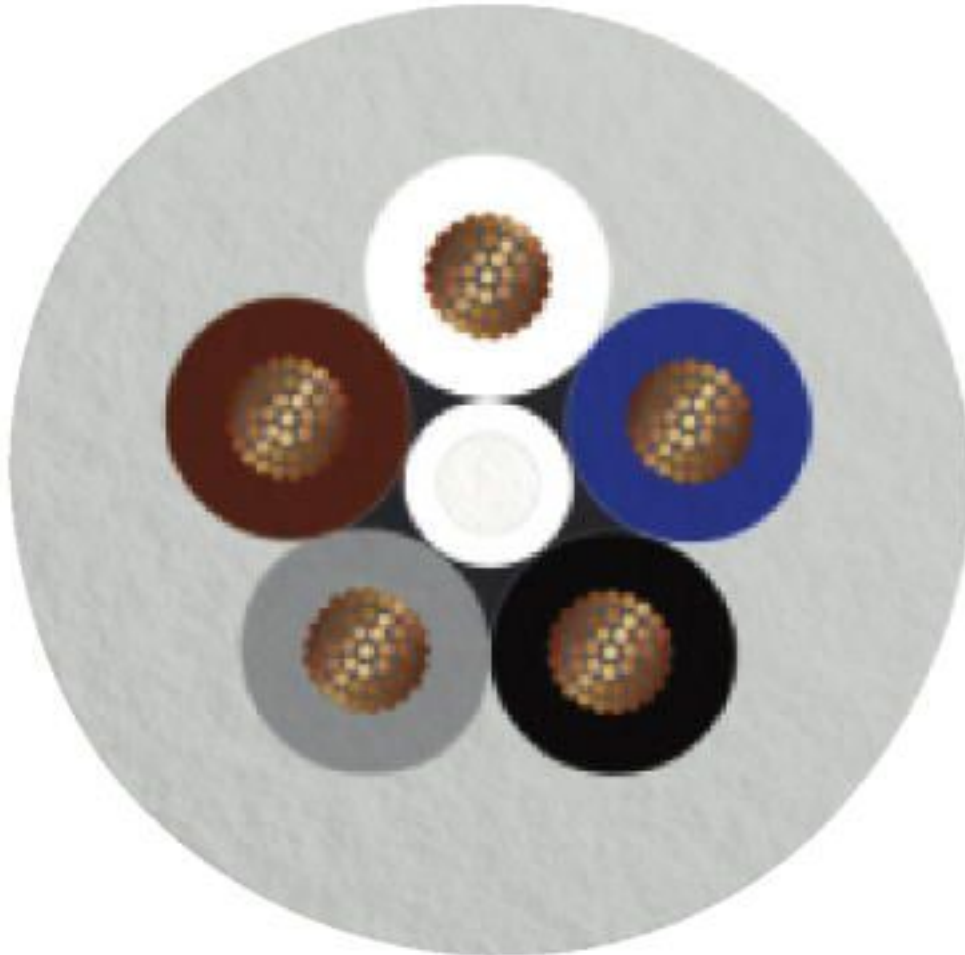

PUR halogen-free gray [280]

Classifications

eCl@ss

eCl@ss 10.0.1	27440203
eCl@ss 4.0	24010400
eCl@ss 4.1	24010400
eCl@ss 5.0	19030300
eCl@ss 5.1	19030300
eCl@ss 6.0	27279200
eCl@ss 7.0	27279218
eCl@ss 8.0	27440203
eCl@ss 9.0	27440203

Power cable - SAC-5P-M12MRL/10,0-280 FE - 1414862

Classifications

ETIM

ETIM 5.0	EC002311
ETIM 6.0	EC002311
ETIM 7.0	EC002311

Approvals

Approvals

Approvals

UL Listed / cUL Listed / EAC-RoHS / EAC / cULus Listed

Ex Approvals

Approval details

UL Listed		http://database.ul.com/cgi-bin/XYV/template/LISEXT/1FRAME/index.htm	E468743
Nominal voltage UN		63 V	
Nominal current IN		16 A	
mm ² /AWG/kcmil		14	

cUL Listed		http://database.ul.com/cgi-bin/XYV/template/LISEXT/1FRAME/index.htm	E468743
Nominal voltage UN		63 V	
Nominal current IN		16 A	
mm ² /AWG/kcmil		14	

EAC-RoHS		RU D- DE.HB35.B.00387
----------	---	--------------------------

EAC		RU C- DE.BL08.B.00286
-----	---	--------------------------

Power cable - SAC-5P-M12MRL/10,0-280 FE - 1414862

Approvals

cULus Listed



Accessories

Accessories

Protective cap

Sealing cap - PROT-M12 FS - 1560251



M12 sealing cap for unoccupied M12 plugs of the sensor/actuator cable, flush-type plugs and I/O devices in the field

Screwdriver tools

Tool - SAC BIT M12-D16 - 1200305



Nut for assembling sensor/actuator cables with M12 connector and M12 connectors for assembly, knurl diameter: 16 mm, for 4 mm hexagonal drive

Phoenix Contact 2020 © - all rights reserved
<http://www.phoenixcontact.com>

PHOENIX CONTACT GmbH & Co. KG
Flachsmarktstr. 8
32825 Blomberg
Germany
Tel. +49 5235 300
Fax +49 5235 3 41200
<http://www.phoenixcontact.com>

X-ON Electronics

Largest Supplier of Electrical and Electronic Components

Click to view similar products for [Sensor Cables / Actuator Cables](#) category:

Click to view products by [Phoenix Contact](#) manufacturer:

Other Similar products are found below :

[60963](#) [60964](#) [703000D02F2002](#) [703001D02F0602](#) [703001D02F300](#) [704000D02F120](#) [773032K02F030](#) [802027107404-1](#) [802027213811-1](#)
[804001A09M150](#) [805001A09M0502](#) [84914-0235](#) [84914-0237](#) [885030A09M020](#) [8R4J30E03C3003](#) [1200651332](#) [1200651713](#) [1200660844](#)
[1200660845](#) [1200661173](#) [1200680071](#) [1200720053](#) [1200720081](#) [1200720099](#) [1200720217](#) [1200800231](#) [1200860125](#) [1200870123](#)
[1200980102](#) [1200650267](#) [1200650298](#) [1200660183](#) [1200660782](#) [1200660849](#) [1200661295](#) [1200661297](#) [1200661342](#) [1200661343](#)
[1200670080](#) [1200670220](#) [1200680331](#) [1200720252](#) [1200730184](#) [1200860344](#) [1200870359](#) [1200870643](#) [1200980008](#) [1200980031](#)
[1210502211](#) [1210400542](#)