

Sensor/actuator cable - SAC-6P-DTMS/ 0,3-PUR/DTFS - 1415035

Please be informed that the data shown in this PDF Document is generated from our Online Catalog. Please find the complete data in the user's documentation. Our General Terms of Use for Downloads are valid (<http://phoenixcontact.com/download>)



Sensor/actuator cable, 6-position, PUR halogen-free, black-gray RAL 7021, Plug straight DEUTSCH DT04-6P Clip locking, on Socket straight DEUTSCH DT06-6S Clip locking, cable length: 0.3 m

RoHS

Key Commercial Data

Packing unit	1 pc
GTIN	 4 055626 037066
GTIN	4055626037066

Technical data

Dimensions

Length of cable	0.3 m
-----------------	-------

Ambient conditions

Ambient temperature (operation)	-20 °C ... 80 °C (Plug / socket)
Degree of protection	IP67

General

Rated current at 40°C	8 A
Rated voltage	48 V AC 48 V DC
Number of positions	6
Color handle area	black
Insulation resistance	≥ 100 MΩ
Coding	A - standard
Status display	No
Protective circuit/component	unwired

Material

Flammability rating according to UL 94	V2
--	----

Sensor/actuator cable - SAC-6P-DTMS/ 0,3-PUR/DTFS - 1415035

Technical data

Material

Contact material	Cu alloy
Contact surface material	Nickel-plated
Contact carrier material	PA 6.6
Material of grip body	PA
Material, knurls	not available
Sealing material	Silicon

Standards and Regulations

Flammability rating according to UL 94	V2
--	----

Cable

Cable type	PUR halogen-free black
Cable type (abbreviation)	PUR
Cable abbreviation	Li9Y11Y
UL AWM style	20549 / 10152 (80°C/300 V)
Conductor cross section	6x 0.75 mm ² (Signal line)
AWG signal line	18
Conductor structure signal line	42x 0.15 mm
Core diameter including insulation	1.69 mm ±0.05 mm (Signal line)
Thickness, insulation	≥ 0.21 mm
Wire colors	brown, white, blue, black, gray, pink
Overall twist	6 wires, horizontally twisted
External sheath, color	black-gray RAL 7021
Outer sheath thickness	≥ 0.38 mm
External cable diameter D	6.5 mm ±0.15 mm
Minimum bending radius, fixed installation	5 x D
Minimum bending radius, flexible installation	10 x D
Number of bending cycles	4000000
Bending radius	48 mm
Traversing path	10 m
Traversing rate	3 m/s
Acceleration	10 m/s ²
Cable weight	68 kg/km
Outer sheath, material	PUR
Material conductor insulation	PP
Conductor material	Bare Cu litz wires
Insulation resistance	≥ 1 GΩ*km (at 20 °C)
Conductor resistance	≤ 26 Ω/km (at 20 °C)
Nominal voltage, cable	≤ 300 V AC
Test voltage, cable	≥ 3000 V AC (Spark test)
Special properties	flexible
	Flexible cable conduit capable

Sensor/actuator cable - SAC-6P-DTMS/ 0,3-PUR/DTFS - 1415035

Technical data

Cable

Flame resistance	according to UL 758/1581 (horizontal)
	in accordance with UL 758/1581 FT2
	according to DIN EN 60332-2-2
Halogen-free	in accordance with DIN VDE 0472 part 815
	in accordance with DIN EN 50267-2-1
Resistance to oil	According to DIN EN 60811-2-1, 168 h at 100°C
	According to UL 758, 168 h at 60°C
Other resistance	hydrolysis and microbe resistant
	partly UV-resistant in accordance with DIN EN ISO 4892-2-A
	Low adhesion
	abrasion-resistant
Ambient temperature (operation)	-40 °C ... 80 °C (cable, fixed installation)
	-25 °C ... 80 °C (cable, flexible installation)

Environmental Product Compliance

China RoHS	Environmentally friendly use period: unlimited = EFUP-e
	No hazardous substances above threshold values

Drawings

Sensor/actuator cable - SAC-6P-DTMS/ 0,3-PUR/DTFS - 1415035

Schematic diagram

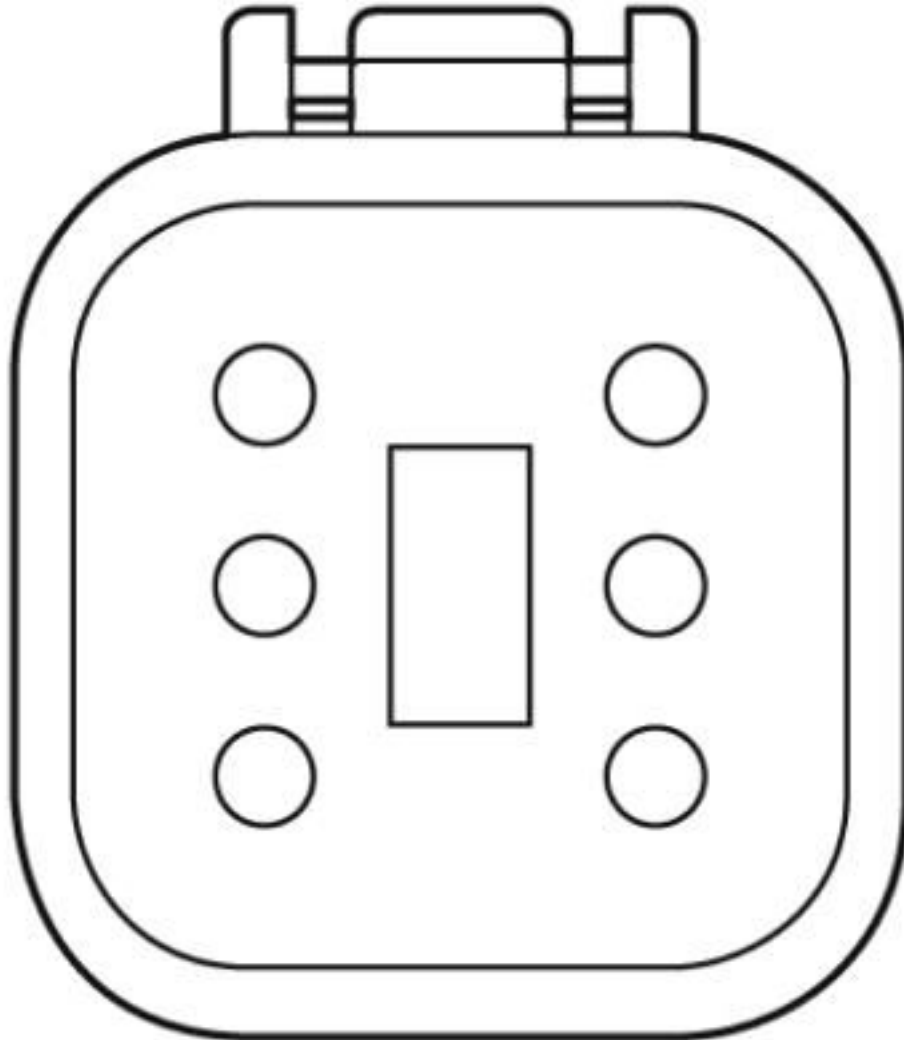

DEUTSCH DT06-6S pin assignment

Sensor/actuator cable - SAC-6P-DTMS/ 0,3-PUR/DTFS - 1415035

Schematic diagram

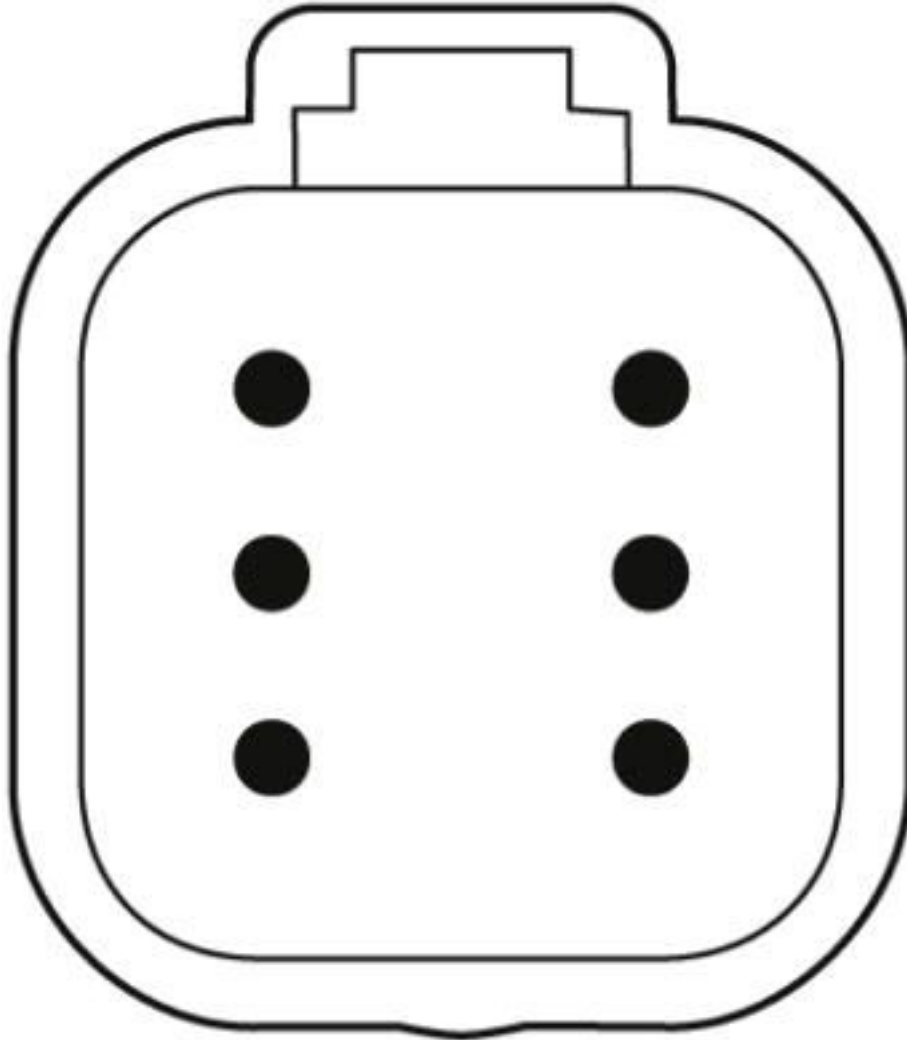

DEUTSCH DT04-6P pin assignment

Sensor/actuator cable - SAC-6P-DTMS/ 0,3-PUR/DTFS - 1415035

Dimensional drawing

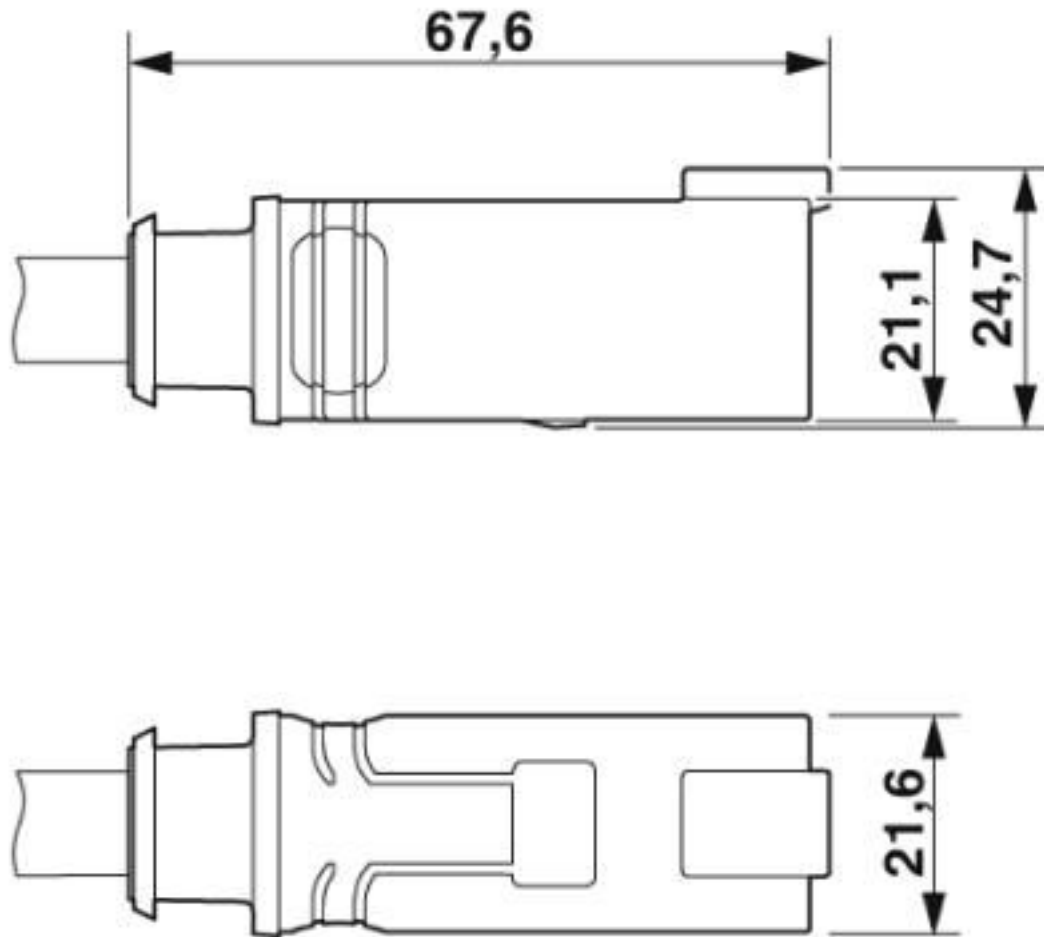

DEUTSCH DT04-6P, top view and side view

Sensor/actuator cable - SAC-6P-DTMS/ 0,3-PUR/DTFS - 1415035

Dimensional drawing

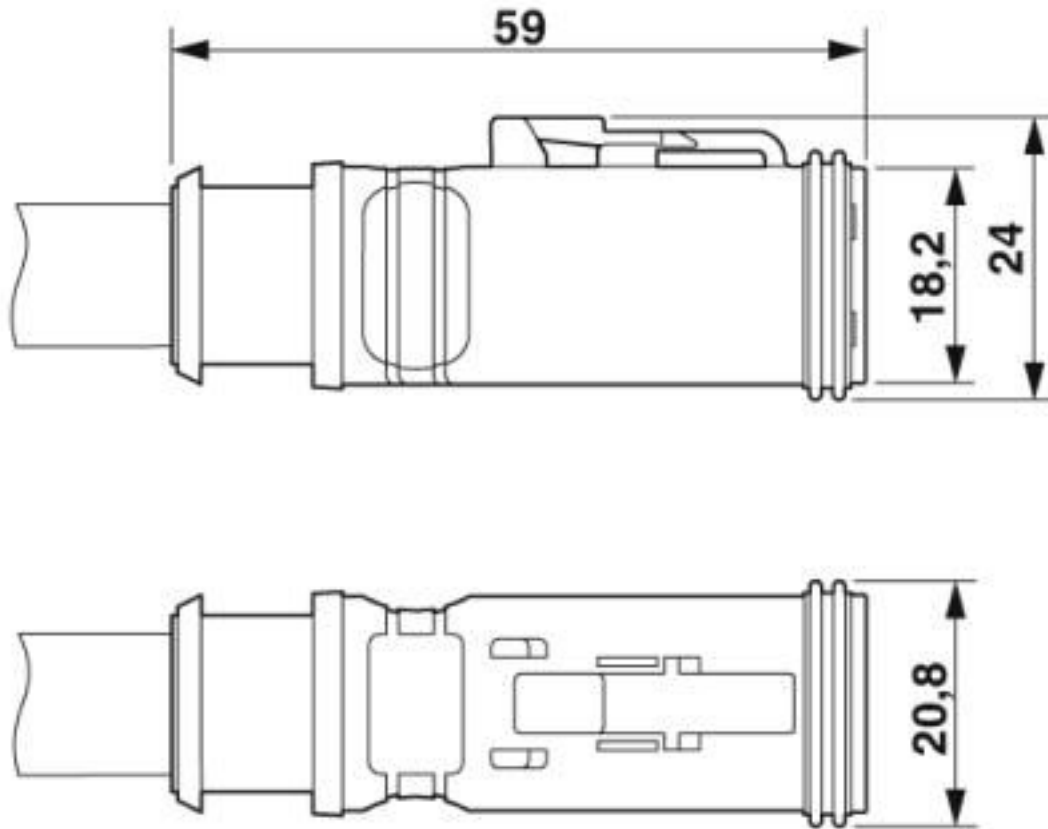

DEUTSCH DT06-3S, top view and side view

Sensor/actuator cable - SAC-6P-DTMS/ 0,3-PUR/DTFS - 1415035

Circuit diagram

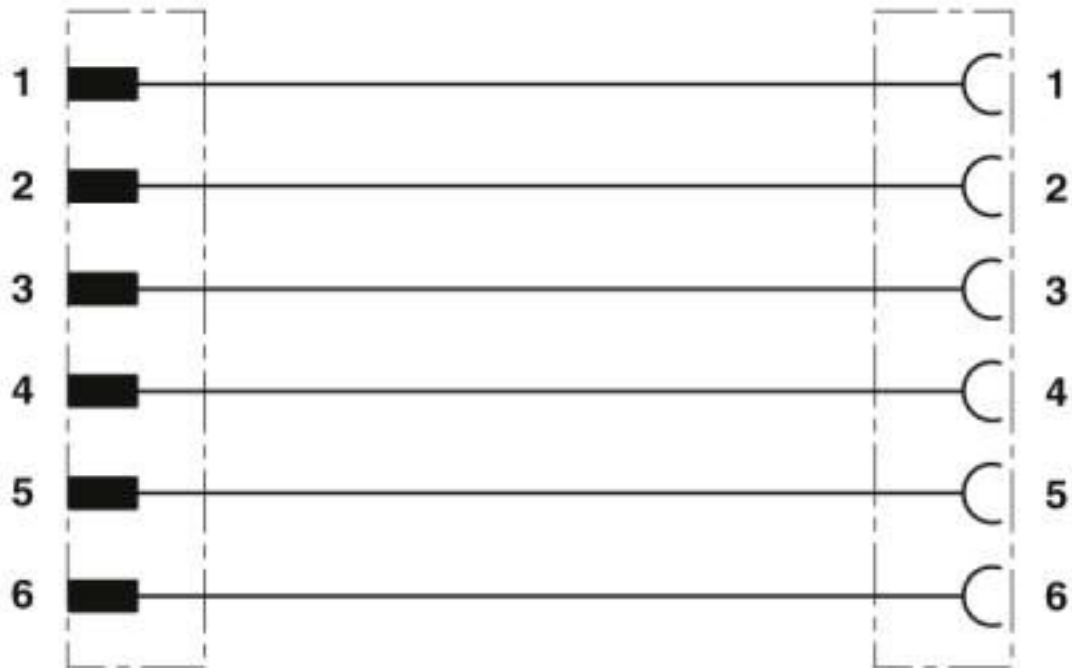

Contact assignment of the DEUTSCH connectors

Sensor/actuator cable - SAC-6P-DTMS/ 0,3-PUR/DTFS - 1415035

Cable cross section



PUR halogen-free black [PUR]

Classifications

eCl@ss

eCl@ss 10.0.1	27060311
eCl@ss 4.0	27060300
eCl@ss 4.1	27060300
eCl@ss 5.0	27061800
eCl@ss 5.1	27061800
eCl@ss 6.0	27279200
eCl@ss 7.0	27279218
eCl@ss 8.0	27279218
eCl@ss 9.0	27060311

Sensor/actuator cable - SAC-6P-DTMS/ 0,3-PUR/DTFS - 1415035

Classifications

ETIM

ETIM 5.0	EC001855
ETIM 6.0	EC001855
ETIM 7.0	EC001855

UNSPSC

UNSPSC 13.2	31251501
UNSPSC 19.0	31251501
UNSPSC 20.0	31251501
UNSPSC 21.0	31251501

Approvals

Approvals

Approvals

EAC-RoHS

Ex Approvals

Approval details

EAC-RoHS		RU D- DE.HB35.B.00387
----------	--	--------------------------

Accessories

Accessories

Conductor marking

Insert label - PABA WH/23 - 1013779



Insert label, Strip, white, unlabeled, can be labeled with: CMS-P1-PLOTTER, mounting type: thread on, cable diameter range: 1.5 ... 35 mm, lettering field size: 23 x 4 mm, Number of individual labels: 20

Sensor/actuator cable - SAC-6P-DTMS/ 0,3-PUR/DTFS - 1415035

Accessories

Insert label - PABA YE/23 - 1013782



Insert label, Strip, yellow, unlabeled, can be labeled with: CMS-P1-PLOTTER, mounting type: thread on, cable diameter range: 1.5 ... 35 mm, lettering field size: 23 x 4 mm, Number of individual labels: 20

Marker pen

Marker pen - B-STIFT - 1051993



Marker pen, for manual labeling of unprinted Zack strips, smear-proof and waterproof, line thickness 0.5 mm

Phoenix Contact 2020 © - all rights reserved
<http://www.phoenixcontact.com>

PHOENIX CONTACT GmbH & Co. KG
Flachsmarktstr. 8
32825 Blomberg
Germany
Tel. +49 5235 300
Fax +49 5235 3 41200
<http://www.phoenixcontact.com>

X-ON Electronics

Largest Supplier of Electrical and Electronic Components

Click to view similar products for [Sensor Cables / Actuator Cables](#) category:

Click to view products by [Phoenix Contact](#) manufacturer:

Other Similar products are found below :

[60963](#) [60964](#) [703000D02F2002](#) [703001D02F0602](#) [703001D02F300](#) [704000D02F120](#) [773032K02F030](#) [802027107404-1](#) [802027213811-1](#)
[804001A09M150](#) [805001A09M0502](#) [84914-0235](#) [84914-0237](#) [885030A09M020](#) [8R4J30E03C3003](#) [1200651332](#) [1200651713](#) [1200660844](#)
[1200660845](#) [1200661173](#) [1200680071](#) [1200720053](#) [1200720081](#) [1200720099](#) [1200720217](#) [1200800231](#) [1200860125](#) [1200870123](#)
[1200980102](#) [1200650267](#) [1200650298](#) [1200660183](#) [1200660782](#) [1200660849](#) [1200661295](#) [1200661297](#) [1200661342](#) [1200661343](#)
[1200670080](#) [1200670220](#) [1200680331](#) [1200720252](#) [1200730184](#) [1200860344](#) [1200870359](#) [1200870643](#) [1200980008](#) [1200980031](#)
[1210502211](#) [1210400542](#)