

Sensor/actuator cable - SAC-4P-M 8MS/3,0-PVC/M 8FS - 1415560

Please be informed that the data shown in this PDF Document is generated from our Online Catalog. Please find the complete data in the user's documentation. Our General Terms of Use for Downloads are valid (<http://phoenixcontact.com/download>)



Sensor/actuator cable, 4-position, PVC, black RAL 9005, Plug straight M8, on Socket straight M8, cable length: 3 m

Your advantages

- ✔ Easy and safe: 100% electrically tested plug-in components



Key Commercial Data

Packing unit	1 pc
GTIN	
GTIN	4055626049410

Technical data

Dimensions

Length of cable	3 m
-----------------	-----

Ambient conditions

Ambient temperature (operation)	-25 °C ... 90 °C (Plug / socket)
Degree of protection	IP65
	IP67
	IP68

General

Rated current at 40°C	4 A
Rated voltage	48 V AC
	60 V DC
Number of positions	4
Insulation resistance	≥ 100 MΩ
Coding	A - standard
Standards/regulations	M8 connector IEC 61076-2-104

Sensor/actuator cable - SAC-4P-M 8MS/3,0-PVC/M 8FS - 1415560

Technical data

General

Status display	No
Protective circuit/component	unwired
Overvoltage category	II
Degree of pollution	3
Insertion/withdrawal cycles	≥ 100

Material

Flammability rating according to UL 94	HB
Contact material	CuSn
Contact surface material	Ni/Au
Contact carrier material	TPU GF
Material of grip body	TPU, hardly inflammable, self-extinguishing
Material, knurls	Zinc die-cast, nickel-plated
Sealing material	NBR

Standards and Regulations

Standards/specifications	M8 connector IEC 61076-2-104
Flammability rating according to UL 94	HB

Cable

Cable type	PVC black
Cable type (abbreviation)	PVC
Cable abbreviation	LiYY
UL AWM style	2464 / 1729 (80°C/300 V)
Conductor cross section	4x 0.25 mm ² (Signal line)
AWG signal line	24
Conductor structure signal line	14x 0.15 mm
Core diameter including insulation	1.17 mm ±0.05 mm
Thickness, insulation	≥ 0.23 mm (Core insulation)
	≥ 0.76 mm (Outer cable sheath)
Wire colors	brown, white, blue, black
Overall twist	4 wires, twisted
External sheath, color	black RAL 9005
External cable diameter D	4.4 mm ±0.15 mm
Minimum bending radius, fixed installation	5 x D
Minimum bending radius, flexible installation	10 x D
Cable weight	33 kg/km
Outer sheath, material	PVC
Material conductor insulation	PVC
Conductor material	Bare Cu litz wires
Insulation resistance	≥ 100 MΩ*km (at 20 °C)
Conductor resistance	max. 79 Ω/km (at 20 °C)

Sensor/actuator cable - SAC-4P-M 8MS/3,0-PVC/M 8FS - 1415560

Technical data

Cable

Nominal voltage, cable	≤ 300 V
Test voltage, cable	≥ 3000 V
Flame resistance	As per UL-Style 2464
Ambient temperature (operation)	-40 °C ... 80 °C (cable, fixed installation)
	-25 °C ... 80 °C (cable, flexible installation)

Environmental Product Compliance

REACH SVHC	Lead 7439-92-1
China RoHS	Environmentally Friendly Use Period = 50 years
	For details about hazardous substances go to tab "Downloads", Category "Manufacturer's declaration"

Drawings

Dimensional drawing

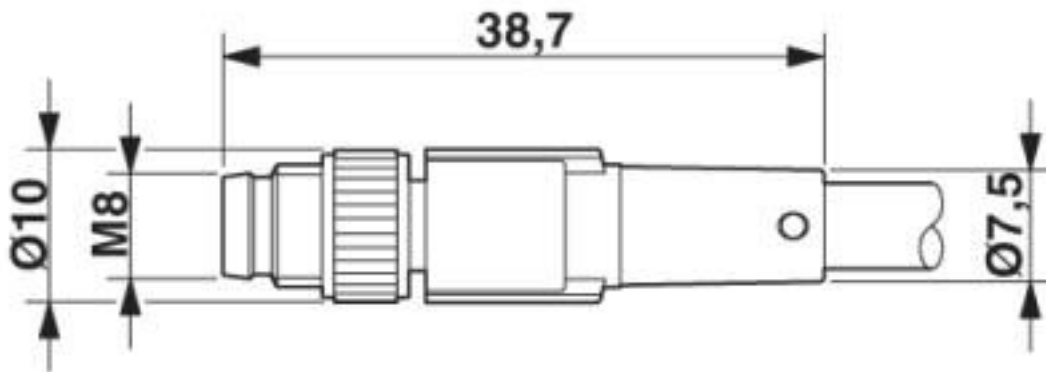

M8 x 1 male plug, straight version

Dimensional drawing

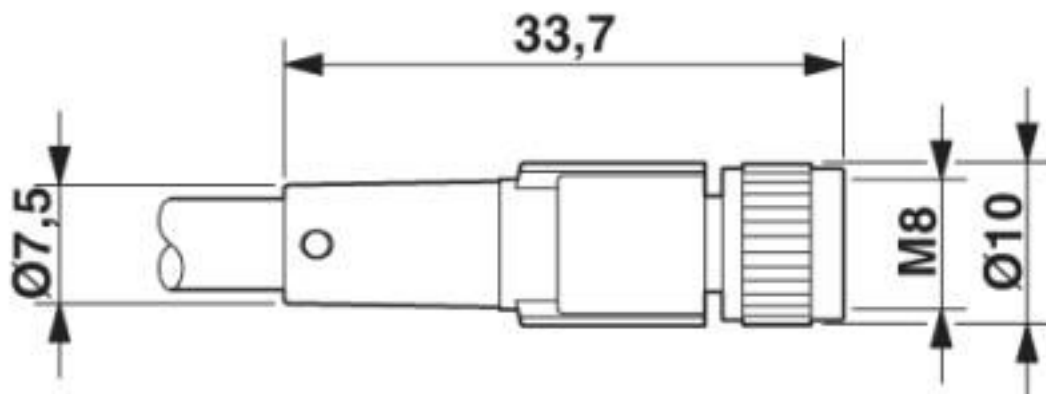

Socket M8 x 1, straight

Sensor/actuator cable - SAC-4P-M 8MS/3,0-PVC/M 8FS - 1415560

Circuit diagram

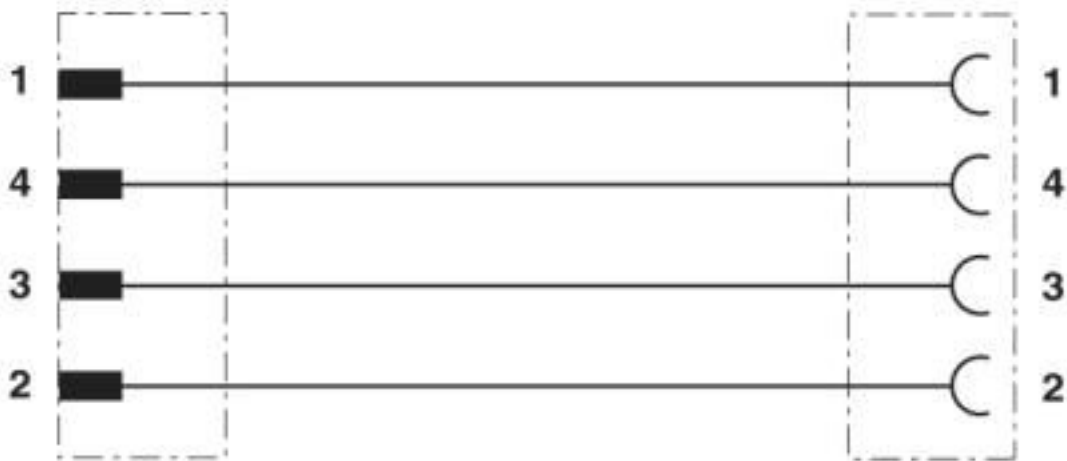

Contact assignment of M8 plugs/sockets

Sensor/actuator cable - SAC-4P-M 8MS/3,0-PVC/M 8FS - 1415560

Schematic diagram



Pin assignment M8 plug, 4-pos., view male side

Sensor/actuator cable - SAC-4P-M 8MS/3,0-PVC/M 8FS - 1415560

Schematic diagram



Pin assignment M8 socket, 4-pos., view female side

Sensor/actuator cable - SAC-4P-M 8MS/3,0-PVC/M 8FS - 1415560

Cable cross section

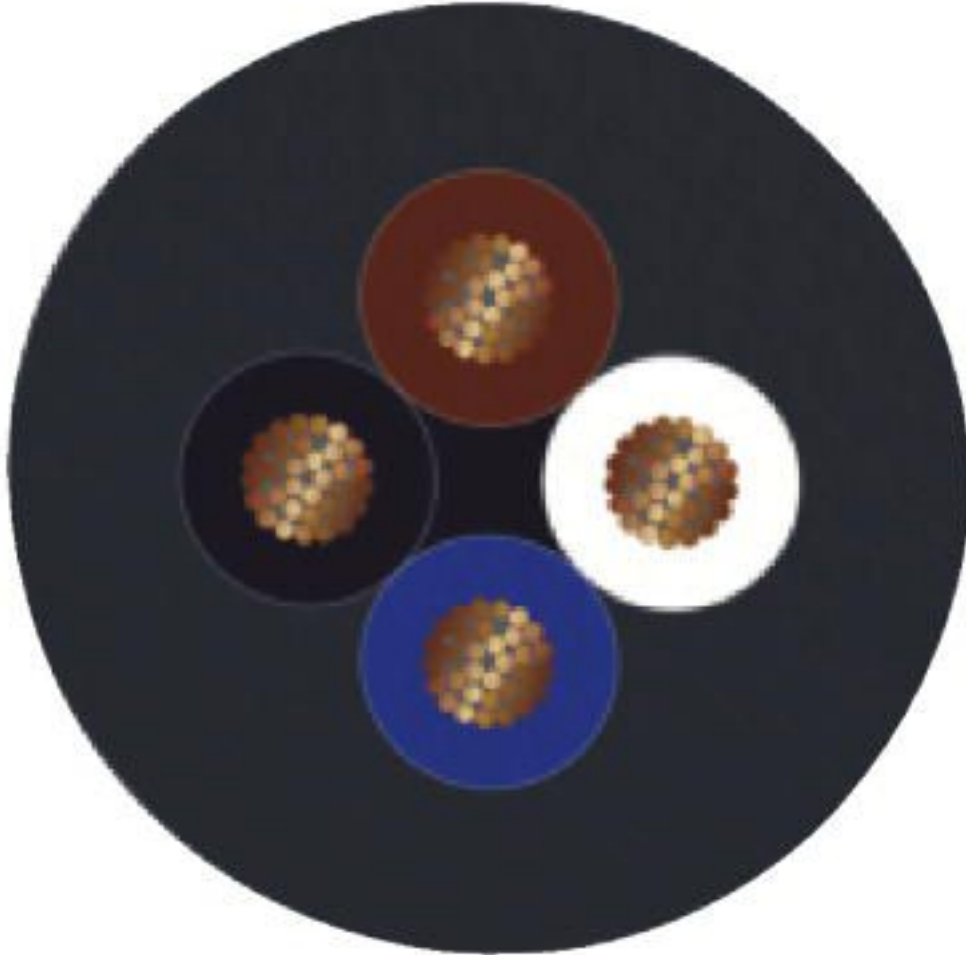

PVC black [PVC]

Classifications

eCl@ss

eCl@ss 10.0.1	27060311
eCl@ss 4.0	27060300
eCl@ss 4.1	27060300
eCl@ss 5.0	27061800
eCl@ss 5.1	27061800
eCl@ss 6.0	27279200
eCl@ss 7.0	27279218
eCl@ss 8.0	27279218
eCl@ss 9.0	27060311

Sensor/actuator cable - SAC-4P-M 8MS/3,0-PVC/M 8FS - 1415560

Classifications

ETIM

ETIM 5.0	EC001855
ETIM 6.0	EC001855
ETIM 7.0	EC001855

UNSPSC

UNSPSC 13.2	31251501
UNSPSC 19.0	31251501
UNSPSC 20.0	31251501
UNSPSC 21.0	31251501

Approvals

Approvals

Approvals

UL Listed / cUL Listed / EAC-RoHS / EAC / cULus Listed

Ex Approvals

Approval details

UL Listed		http://database.ul.com/cgi-bin/XYV/template/LISEXT/1FRAME/index.htm	FILE E 221474
Nominal voltage UN		30 V	
Nominal current IN		4 A	

cUL Listed		http://database.ul.com/cgi-bin/XYV/template/LISEXT/1FRAME/index.htm	FILE E 221474
Nominal voltage UN		30 V	
Nominal current IN		4 A	

EAC-RoHS		RU D-DE.HB35.B.00387
----------	---	----------------------

Sensor/actuator cable - SAC-4P-M 8MS/3,0-PVC/M 8FS - 1415560

Approvals

EAC		RU C- DE.BL08.B.00286
-----	--	--------------------------

cULus Listed	
--------------	--

Accessories

Accessories

Conductor marking

Insert label - PABA WH/23 - 1013779



Insert label, Strip, white, unlabeled, can be labeled with: CMS-P1-PLOTTER, mounting type: thread on, cable diameter range: 1.5 ... 35 mm, lettering field size: 23 x 4 mm, Number of individual labels: 20

Insert label - PABA YE/23 - 1013782



Insert label, Strip, yellow, unlabeled, can be labeled with: CMS-P1-PLOTTER, mounting type: thread on, cable diameter range: 1.5 ... 35 mm, lettering field size: 23 x 4 mm, Number of individual labels: 20

Marker pen

Marker pen - B-STIFT - 1051993



Marker pen, for manual labeling of unprinted Zack strips, smear-proof and waterproof, line thickness 0.5 mm

Plug for cable screw gland

Sensor/actuator cable - SAC-4P-M 8MS/3,0-PVC/M 8FS - 1415560

Accessories

Screw plug - PROT-M 8 MS-PA-CHAIN - 1430860

M8 sealing cap made of plastic with fixing band for sensor cables, for M8 sockets



Protective cap

Sealing cap - PROT-M 8 FS-PA-CHAIN - 1430857

M8 sealing cap made of plastic with fixing band for sensor cables, for M8 plugs



Screwdriver tools

Tool - SAC BIT M8-D10 - 1208461



Nut for assembling M8 connectors with longitudinal knurl and a knurl diameter of 10 mm, for 4 mm hexagonal drive

Torque tool

Torque screwdriver - TSD 02 SAC - 1208487



Torque screwdriver, with preset torque of 0.2 Nm and 4 mm hexagonal drive for M8 connectors

X-ON Electronics

Largest Supplier of Electrical and Electronic Components

Click to view similar products for [Sensor Cables / Actuator Cables](#) category:

Click to view products by [Phoenix Contact](#) manufacturer:

Other Similar products are found below :

[60963](#) [60964](#) [703000D02F2002](#) [703001D02F0602](#) [703001D02F300](#) [704000D02F120](#) [773032K02F030](#) [802027107404-1](#) [802027213811-1](#)
[804001A09M150](#) [805001A09M0502](#) [84914-0235](#) [84914-0237](#) [885030A09M020](#) [8R4J30E03C3003](#) [1200651332](#) [1200651713](#) [1200660844](#)
[1200660845](#) [1200661173](#) [1200680071](#) [1200720053](#) [1200720081](#) [1200720099](#) [1200720217](#) [1200800231](#) [1200860125](#) [1200870123](#)
[1200980102](#) [1200650267](#) [1200650298](#) [1200660183](#) [1200660782](#) [1200660849](#) [1200661295](#) [1200661297](#) [1200661342](#) [1200661343](#)
[1200670080](#) [1200670220](#) [1200680331](#) [1200720252](#) [1200730184](#) [1200860344](#) [1200870359](#) [1200870643](#) [1200980008](#) [1200980031](#)
[1210502211](#) [1210400542](#)