

## Sensor/actuator cable - SAC-4P-M12MR/5,0-PVC - 1415593

Please be informed that the data shown in this PDF Document is generated from our Online Catalog. Please find the complete data in the user's documentation. Our General Terms of Use for Downloads are valid (<http://phoenixcontact.com/download>)



Sensor/actuator cable, 4-position, PVC, black RAL 9005, Plug angled M12, coding: A, on free cable end, cable length: 5 m

### Your advantages

- ✔ Easy and safe: 100% electrically tested plug-in components

### Key Commercial Data

|              |   |
|--------------|---|
| Packing unit | 1 pc  |
| GTIN         | <br>4 055626 049755 |
| GTIN         | 4055626049755   |

### Technical data

#### Dimensions

|                 |     |
|-----------------|-----|
| Length of cable | 5 m |
|-----------------|-----|

#### Ambient conditions

|                                 |                                  |
|---------------------------------|----------------------------------|
| Ambient temperature (operation) | -25 °C ... 90 °C (Plug / socket) |
| Degree of protection            | IP65                             |
|                                 | IP67                             |
|                                 | IP68                             |

#### General

|                       |                               |
|-----------------------|-------------------------------|
| Rated current at 40°C | 4 A                           |
| Rated voltage         | 250 V AC                      |
|                       | 250 V DC                      |
| Number of positions   | 4                             |
| Insulation resistance | ≥ 10 MΩ                       |
| Coding                | A - standard                  |
| Standards/regulations | M12 connector IEC 61076-2-101 |

# Sensor/actuator cable - SAC-4P-M12MR/5,0-PVC - 1415593

## Technical data

### General

|                              |         |
|------------------------------|---------|
| Status display               | No      |
| Protective circuit/component | unwired |
| Overvoltage category         | II      |
| Degree of pollution          | 3       |
| Insertion/withdrawal cycles  | ≥ 100   |
| Torque                       | 0.4 Nm  |

### Material

|  |   |
|--|---|
| Flammability rating according to UL 94 | HB  |
| Contact material                       | CuSn  |
| Contact surface material               | Ni/Au                                       |
| Contact carrier material               | TPU GF                                      |
| Material of grip body                  | TPU, hardly inflammable, self-extinguishing |
| Material, knurls                       | Zinc die-cast, nickel-plated                |

### Standards and Regulations

|  |                               |
|--|-------------------------------|
| Standards/specifications               | M12 connector IEC 61076-2-101 |
| Flammability rating according to UL 94 | HB                            |

### Cable

|   |                                       |
|---|---------------------------------------|
| Cable type                                    | PVC black                             |
| Cable type (abbreviation)                     | PVC                                   |
| Cable abbreviation                            | LiYY                                  |
| UL AWM style                                  | 2464 / 1729 (80°C/300 V)              |
| Conductor cross section                       | 4x 0.34 mm <sup>2</sup> (Signal line) |
| AWG signal line                               | 22                                    |
| Conductor structure signal line               | 19x 0.15 mm                           |
| Core diameter including insulation            | 1.26 mm ±0.05 mm                      |
| Thickness, insulation                         | ≥ 0.23 mm (Core insulation)           |
| Wire colors                                   | brown, white, blue, black             |
| Overall twist                                 | 4 wires, twisted                      |
| External sheath, color                        | black RAL 9005                        |
| Outer sheath thickness                        | ≥ 0.76 mm                             |
| External cable diameter D                     | 4.7 mm ±0.15 mm                       |
| Minimum bending radius, fixed installation    | 5 x D                                 |
| Minimum bending radius, flexible installation | 10 x D                                |
| Cable weight                                  | 40 kg/km                              |
| Outer sheath, material                        | PVC                                   |
| Material conductor insulation                 | PVC                                   |
| Conductor material                            | Bare Cu litz wires                    |
| Insulation resistance                         | ≥ 200 MΩ*km (at 20 °C)                |
| Conductor resistance                          | ≤ 57 Ω/km (at 20 °C)                  |

## Sensor/actuator cable - SAC-4P-M12MR/5,0-PVC - 1415593

### Technical data

#### Cable

|                                 |   |
|---------------------------------|---|
| Nominal voltage, cable          | ≤ 300 V   |
| Test voltage, cable             | ≥ 3000 V  |
| Flame resistance                | As per UL-Style 2464                            |
| Resistance to oil               | according to DIN EN 60811-2-1, 168 h at 60 °C   |
| Ambient temperature (operation) | -40 °C ... 80 °C (cable, fixed installation)    |
|                                 | -25 °C ... 80 °C (cable, flexible installation) |

#### Environmental Product Compliance

|            |   |
|------------|---|
| China RoHS | Environmentally friendly use period: unlimited = EFUP-e |
|            | No hazardous substances above threshold values          |

### Drawings

Dimensional drawing

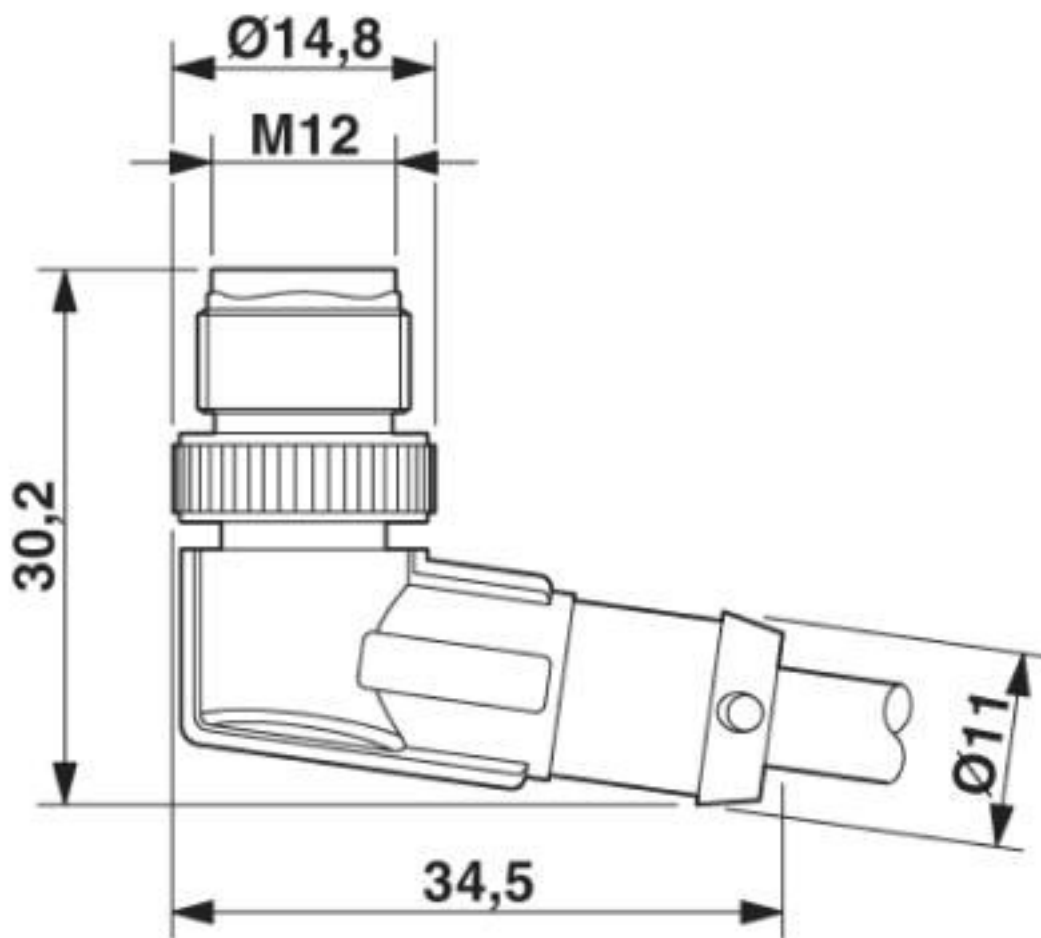

M12 x 1 male plug, angled

## Sensor/actuator cable - SAC-4P-M12MR/5,0-PVC - 1415593

Circuit diagram

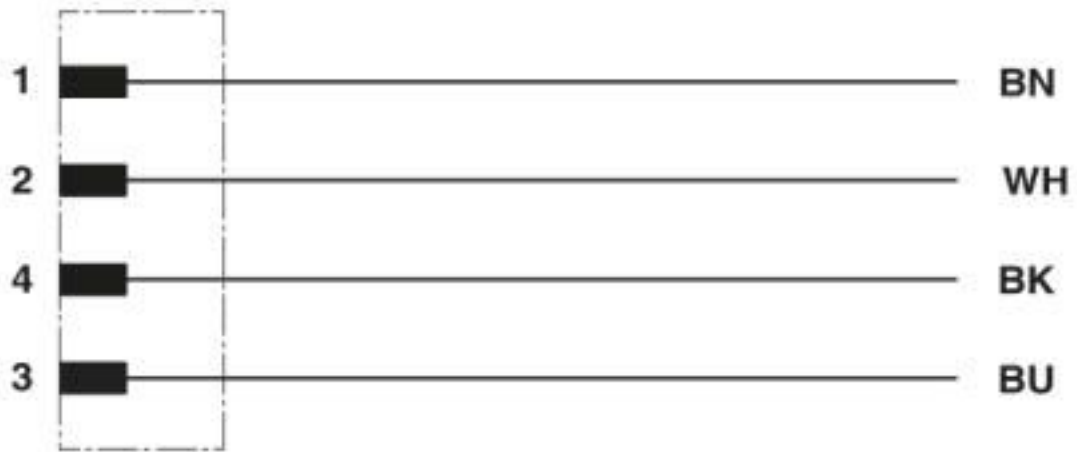

Contact assignment of the M12 plug

## Sensor/actuator cable - SAC-4P-M12MR/5,0-PVC - 1415593

Schematic diagram



Pin assignment M12 plug, 4-pos., A-coded, view plug side

# Sensor/actuator cable - SAC-4P-M12MR/5,0-PVC - 1415593

Cable cross section

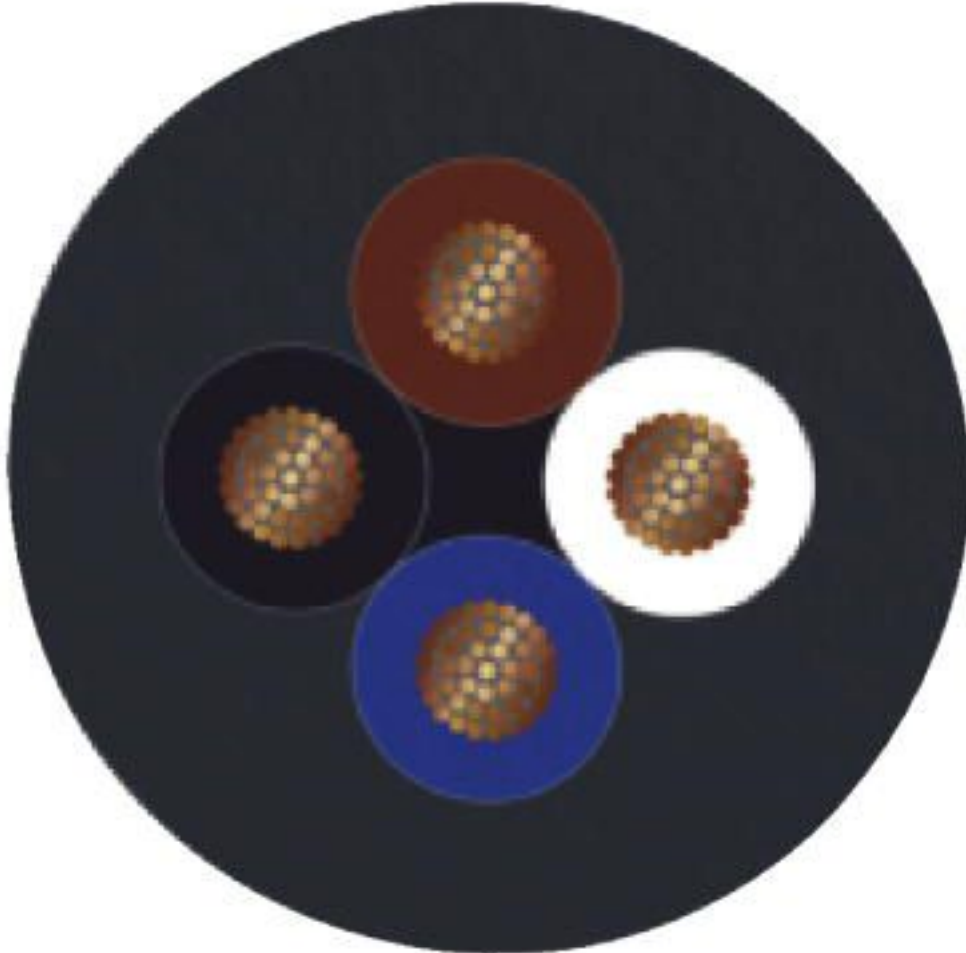

PVC black [PVC]

## Classifications

eCl@ss

|               |          |
|---------------|----------|
| eCl@ss 10.0.1 | 27060311 |
| eCl@ss 4.0    | 27060300 |
| eCl@ss 4.1    | 27060300 |
| eCl@ss 5.0    | 27061800 |
| eCl@ss 5.1    | 27061800 |
| eCl@ss 6.0    | 27279200 |
| eCl@ss 7.0    | 27279218 |
| eCl@ss 8.0    | 27279218 |
| eCl@ss 9.0    | 27060311 |

# Sensor/actuator cable - SAC-4P-M12MR/5,0-PVC - 1415593

## Classifications

### ETIM

|          |          |
|----------|----------|
| ETIM 5.0 | EC001855 |
| ETIM 6.0 | EC001855 |
| ETIM 7.0 | EC001855 |

### UNSPSC

|             |          |
|-------------|----------|
| UNSPSC 13.2 | 31251501 |
| UNSPSC 19.0 | 31251501 |
| UNSPSC 20.0 | 31251501 |
| UNSPSC 21.0 | 31251501 |

## Approvals

### Approvals

#### Approvals

UL Listed / cUL Listed / EAC-RoHS / EAC / cULus Listed

#### Ex Approvals

### Approval details

|                    |   |   |               |
|--------------------|---|---|---------------|
| UL Listed          |  | <a href="http://database.ul.com/cgi-bin/XYV/template/LISEXT/1FRAME/index.htm">http://database.ul.com/cgi-bin/XYV/template/LISEXT/1FRAME/index.htm</a> | FILE E 221474 |
| Nominal voltage UN |   | 300 V   |               |
| Nominal current IN |   | 4 A   |               |

|                    |   |   |               |
|--------------------|---|---|---------------|
| cUL Listed         |  | <a href="http://database.ul.com/cgi-bin/XYV/template/LISEXT/1FRAME/index.htm">http://database.ul.com/cgi-bin/XYV/template/LISEXT/1FRAME/index.htm</a> | FILE E 221474 |
| Nominal voltage UN |   | 300 V   |               |
| Nominal current IN |   | 4 A   |               |

|          |   |                      |
|----------|---|----------------------|
| EAC-RoHS |  | RU D-DE.HB35.B.00387 |
|----------|---|----------------------|

# Sensor/actuator cable - SAC-4P-M12MR/5,0-PVC - 1415593

## Approvals

|     |  |                          |
|-----|--|--------------------------|
| EAC |  | RU C-<br>DE.BL08.B.00286 |
|-----|--|--------------------------|

|              |  |
|--------------|--|
| cULus Listed |  |
|--------------|--|

## Accessories

### Accessories

#### Conductor marking

Insert label - PABA WH/23 - 1013779



Insert label, Strip, white, unlabeled, can be labeled with: CMS-P1-PLOTTER, mounting type: thread on, cable diameter range: 1.5 ... 35 mm, lettering field size: 23 x 4 mm, Number of individual labels: 20

Insert label - PABA YE/23 - 1013782



Insert label, Strip, yellow, unlabeled, can be labeled with: CMS-P1-PLOTTER, mounting type: thread on, cable diameter range: 1.5 ... 35 mm, lettering field size: 23 x 4 mm, Number of individual labels: 20

#### Corrugated pipe

Protective hose - WP-PA HF 13,0 BK - 3240681



Polyamide protective hose, inflammability class V0, UV resistant

Protective hose - WP-PA HF-HB 13,0 BK - 3240839



Polyamide protective hose, inflammability class HB, UV resistant



## Sensor/actuator cable - SAC-4P-M12MR/5,0-PVC - 1415593

### Accessories

---

#### Cutting tools

Diagonal cutter - CUTFOX-S VDE - 1212207



Diagonal cutter for hard (piano wire) and soft wires, VDE 1000 V AC/1500 V DC tested

---

#### Marker pen

Marker pen - B-STIFT - 1051993



Marker pen, for manual labeling of unprinted Zack strips, smear-proof and waterproof, line thickness 0.5 mm

---

#### Protective cap

Sealing cap - PROT-M12 FS-PA-CHAIN - 1430873



M12 sealing cap made of plastic with fixing band, for sensor cables, for free M12 plugs

---

#### Safety locking

Locking clip - SAC-M12-EXCLIP-M - 1558988



Locking clip for the pin side of sensor/actuator cables with M12 connector and M12 connectors for assembly, for knurl diameter: 15 mm or for Allen key with a wrench size of 14 mm, prevents the disconnection of plug-in connections without tools

---

#### Screwdriver tools

## Sensor/actuator cable - SAC-4P-M12MR/5,0-PVC - 1415593

### Accessories

Adapter insert - TSD-M SAC-BIT ADAPTER - 1212600



Adapter bit for TSD-M...torque tools, E6.3-1/4" drive with 4 mm hexagon to accommodate SAC bits

---

Tool - SAC BIT M12-D15 - 1208432



Nut for assembling sensor/actuator cables with M12 connector and M12 connectors for assembly, with a knurl diameter of 15 mm, for 4 mm hexagonal drive

---

### Stripping tool

Stripping tool - WIREFOX SAC-1 - 1212757



Stripping pliers, for halogen-free sensor/actuator cables (SAC cables), with PUR and PVC insulation, from  $\varnothing$  of 3.2 to 4.4 mm, any stripping length

---

Stripping tool - WIREFOX SAC - 1212623



Stripping pliers, for halogen-free sensor/actuator cables (SAC cables), with PUR and PVC insulation, from  $\varnothing$  of 4.4 to 7 mm, any stripping length

---

Stripping tool - WIREFOX 10 - 1212150



Stripping tool, for cables and conductors from 0.02 - 10 mm<sup>2</sup>, self-adjusting, stripping length of up to 18 mm, cutting capacity of up to 10 mm<sup>2</sup> stranded/1.5 mm<sup>2</sup> solid, replaceable stripping blade

---

### Torque tool

## Sensor/actuator cable - SAC-4P-M12MR/5,0-PVC - 1415593

### Accessories

Torque screwdriver - TSD 04 SAC - 1208429



Torque screwdriver, with preset torque of 0.4 Nm and 4 mm hexagonal drive for M12 connectors

---

Torque screwdriver - TSD-M 1,2NM - 1212224



Torque screw driver, accuracy as per EN ISO 6789 standard, adjustable from 0.3 - 1.2 Nm

---

Protective hose adapter - WP-CTA POM 13,0 BK - 1422884



Protective hose adapter, for corrugated hoses with a nominal size of 13 (10 x 13), corrugated in parallel

---

---

Phoenix Contact 2020 © - all rights reserved  
<http://www.phoenixcontact.com>

PHOENIX CONTACT GmbH & Co. KG  
Flachsmarktstr. 8  
32825 Blomberg  
Germany  
Tel. +49 5235 300  
Fax +49 5235 3 41200  
<http://www.phoenixcontact.com>

## X-ON Electronics

Largest Supplier of Electrical and Electronic Components

*Click to view similar products for [Sensor Cables / Actuator Cables](#) category:*

*Click to view products by [Phoenix Contact](#) manufacturer:*

Other Similar products are found below :

[60963](#) [60964](#) [703000D02F2002](#) [703001D02F0602](#) [703001D02F300](#) [704000D02F120](#) [773032K02F030](#) [802027107404-1](#) [802027213811-1](#)  
[804001A09M150](#) [805001A09M0502](#) [84914-0235](#) [84914-0237](#) [885030A09M020](#) [8R4J30E03C3003](#) [1200651332](#) [1200651713](#) [1200660844](#)  
[1200660845](#) [1200661173](#) [1200680071](#) [1200720053](#) [1200720081](#) [1200720099](#) [1200720217](#) [1200800231](#) [1200860125](#) [1200870123](#)  
[1200980102](#) [1200650267](#) [1200650298](#) [1200660183](#) [1200660782](#) [1200660849](#) [1200661295](#) [1200661297](#) [1200661342](#) [1200661343](#)  
[1200670080](#) [1200670220](#) [1200680331](#) [1200720252](#) [1200730184](#) [1200860344](#) [1200870359](#) [1200870643](#) [1200980008](#) [1200980031](#)  
[1210502211](#) [1210400542](#)