

Sensor/actuator cable - SAC-4P-M12MS/3,0-PVC/M 8FS - 1415674

Please be informed that the data shown in this PDF Document is generated from our Online Catalog. Please find the complete data in the user's documentation. Our General Terms of Use for Downloads are valid (<http://phoenixcontact.com/download>)



Sensor/actuator cable, 4-position, PVC, black RAL 9005, Plug straight M12, coding: A, on Socket straight M8, cable length: 3 m

Your advantages

- ✓ Easy and safe: 100% electrically tested plug-in components

Key Commercial Data

Packing unit	1 pc
GTIN	 4 055626 050355
GTIN	4055626050355

Technical data

Dimensions

Length of cable	3 m
-----------------	-----

Ambient conditions

Ambient temperature (operation)	-25 °C ... 90 °C (Plug / socket)
Degree of protection	IP65
	IP67
	IP68

General

Rated current at 40°C	4 A
Rated voltage	48 V AC
	60 V DC
Number of positions	4
Insulation resistance	≥ 100 MΩ
Coding	A - standard
Standards/regulations	M12 connector IEC 61076-2-101

Sensor/actuator cable - SAC-4P-M12MS/3,0-PVC/M 8FS - 1415674

Technical data

General

	M8 connector IEC 61076-2-104
Status display	No
Protective circuit/component	unwired
Overvoltage category	II
Degree of pollution	3
Insertion/withdrawal cycles	≥ 100

Material

Flammability rating according to UL 94	HB
Contact material	CuSn
Contact surface material	Ni/Au
Contact carrier material	TPU GF
Material of grip body	TPU, hardly inflammable, self-extinguishing
Material, knurls	Zinc die-cast, nickel-plated
Sealing material	NBR

Standards and Regulations

Standards/specifications	M12 connector IEC 61076-2-101
	M8 connector IEC 61076-2-104
Flammability rating according to UL 94	HB

Cable

Cable type	PVC black
Cable type (abbreviation)	PVC
Cable abbreviation	LiYY
UL AWM style	2464 / 1729 (80°C/300 V)
Conductor cross section	4x 0.34 mm ² (Signal line)
AWG signal line	22
Conductor structure signal line	19x 0.15 mm
Core diameter including insulation	1.26 mm ±0.05 mm
Thickness, insulation	≥ 0.23 mm (Core insulation)
Wire colors	brown, white, blue, black
Overall twist	4 wires, twisted
External sheath, color	black RAL 9005
Outer sheath thickness	≥ 0.76 mm
External cable diameter D	4.7 mm ±0.15 mm
Minimum bending radius, fixed installation	5 x D
Minimum bending radius, flexible installation	10 x D
Cable weight	40 kg/km
Outer sheath, material	PVC
Material conductor insulation	PVC
Conductor material	Bare Cu litz wires

Sensor/actuator cable - SAC-4P-M12MS/3,0-PVC/M 8FS - 1415674

Technical data

Cable

Insulation resistance	≥ 200 MΩ*km (at 20 °C)
Conductor resistance	≤ 57 Ω/km (at 20 °C)
Nominal voltage, cable	≤ 300 V
Test voltage, cable	≥ 3000 V
Flame resistance	As per UL-Style 2464
Resistance to oil	according to DIN EN 60811-2-1, 168 h at 60 °C
Ambient temperature (operation)	-40 °C ... 80 °C (cable, fixed installation)
	-25 °C ... 80 °C (cable, flexible installation)

Environmental Product Compliance

China RoHS	Environmentally friendly use period: unlimited = EFUP-e
	No hazardous substances above threshold values

Drawings

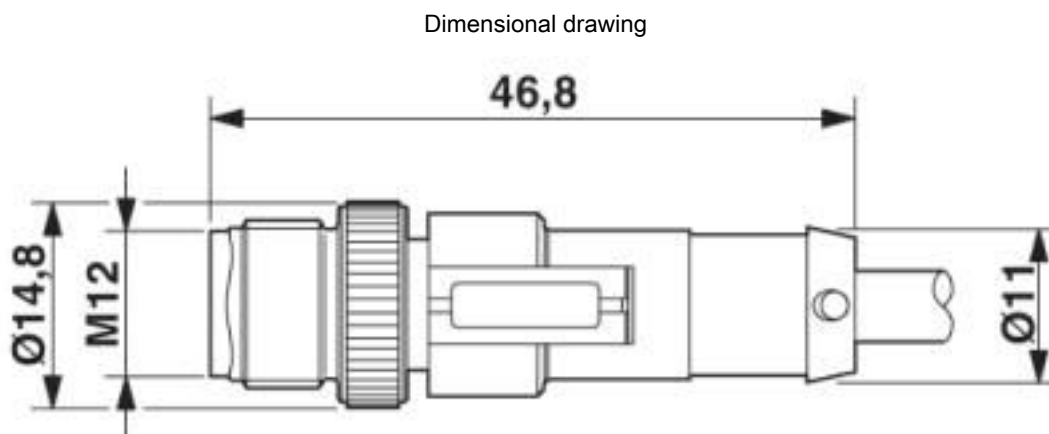

Plug, M12 x 1, straight, shielded

Sensor/actuator cable - SAC-4P-M12MS/3,0-PVC/M 8FS - 1415674

Dimensional drawing

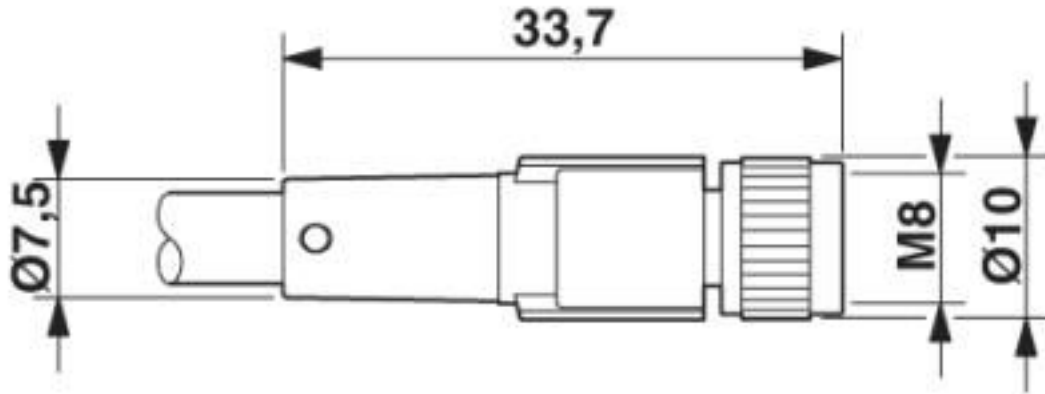

Socket M8 x 1, straight

Circuit diagram

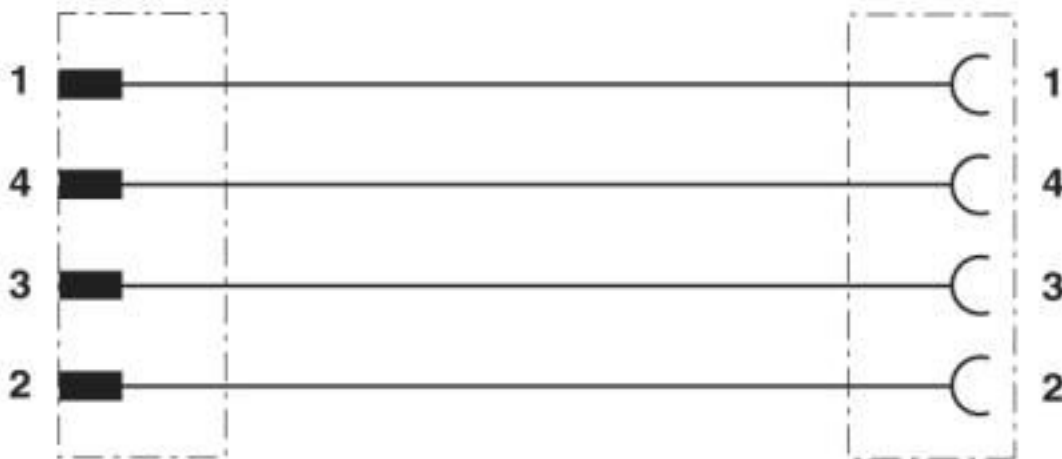

Contact assignment of M12 plugs / M8 sockets

Sensor/actuator cable - SAC-4P-M12MS/3,0-PVC/M 8FS - 1415674

Schematic diagram

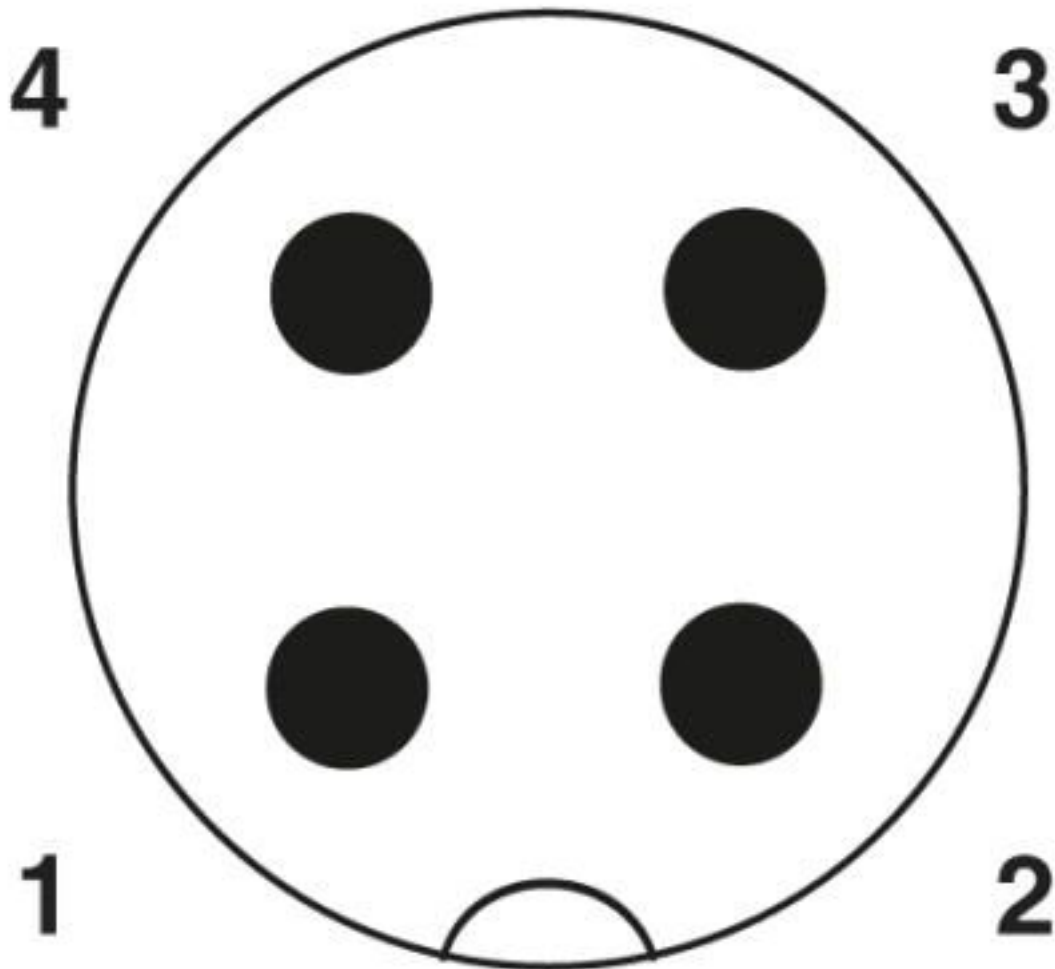

Pin assignment M12 plug, 4-pos., A-coded, view plug side

Sensor/actuator cable - SAC-4P-M12MS/3,0-PVC/M 8FS - 1415674

Schematic diagram

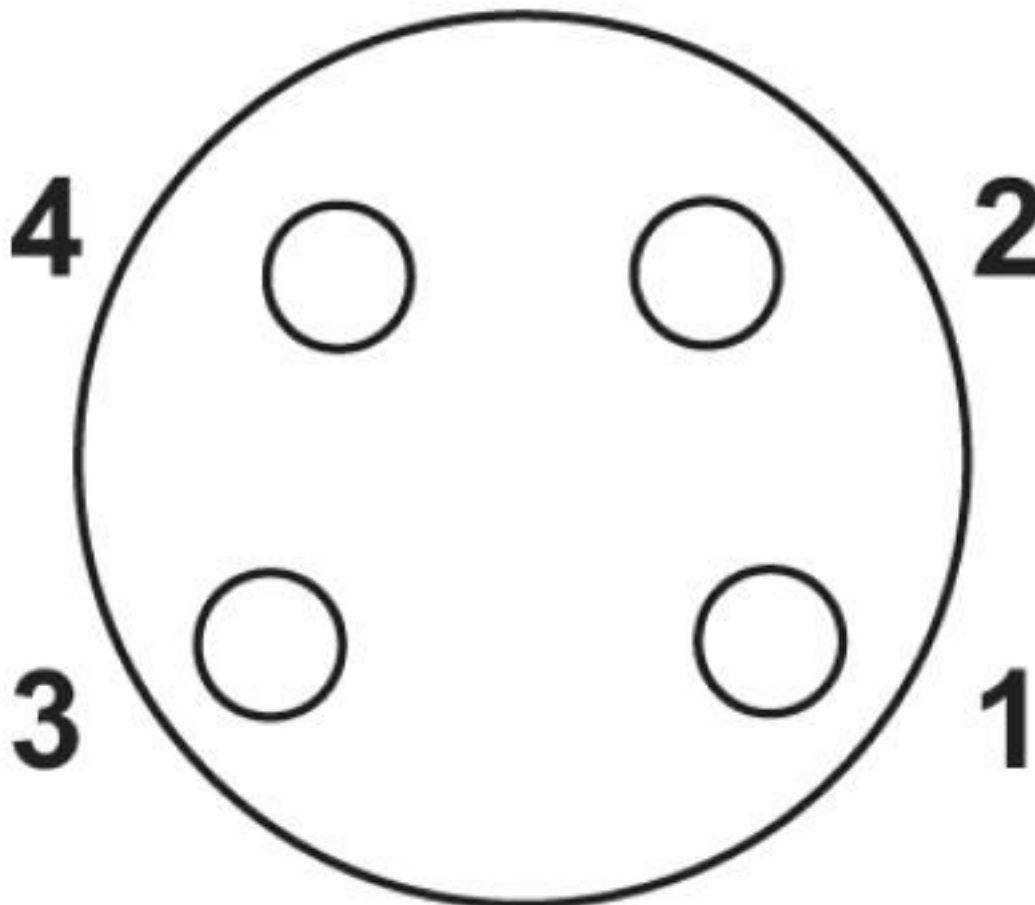

Pin assignment M8 socket, 4-pos., view female side

Sensor/actuator cable - SAC-4P-M12MS/3,0-PVC/M 8FS - 1415674

Cable cross section

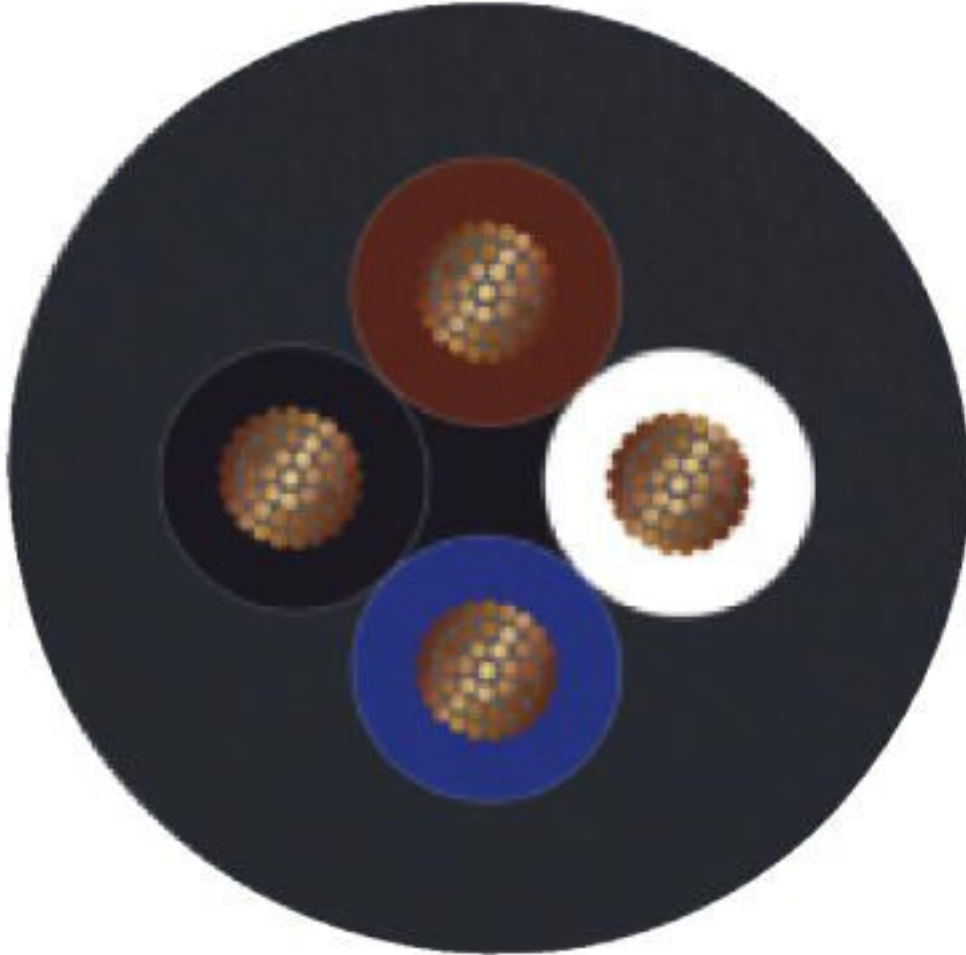

PVC black [PVC]

Classifications

eCl@ss

eCl@ss 10.0.1	27060311
eCl@ss 4.0	27060300
eCl@ss 4.1	27060300
eCl@ss 5.0	27061800
eCl@ss 5.1	27061800
eCl@ss 6.0	27279200
eCl@ss 7.0	27279218
eCl@ss 8.0	27279218
eCl@ss 9.0	27060311

Sensor/actuator cable - SAC-4P-M12MS/3,0-PVC/M 8FS - 1415674

Classifications

ETIM

ETIM 5.0	EC001855
ETIM 6.0	EC001855
ETIM 7.0	EC001855

UNSPSC

UNSPSC 13.2	31251501
UNSPSC 19.0	31251501
UNSPSC 20.0	31251501
UNSPSC 21.0	31251501

Approvals

Approvals

Approvals

UL Listed / cUL Listed / EAC-RoHS / cULus Listed

Ex Approvals

Approval details

UL Listed		http://database.ul.com/cgi-bin/XYV/template/LISEXT/1FRAME/index.htm	FILE E 221474
Nominal voltage UN	30 V		
Nominal current IN	4 A		

cUL Listed		http://database.ul.com/cgi-bin/XYV/template/LISEXT/1FRAME/index.htm	FILE E 221474
Nominal voltage UN	30 V		
Nominal current IN	4 A		

EAC-RoHS		RU D-DE.HB35.B.00387
----------	--	----------------------

Sensor/actuator cable - SAC-4P-M12MS/3,0-PVC/M 8FS - 1415674

Approvals

cULus Listed



Accessories

Accessories

Conductor marking

Insert label - PABA WH/23 - 1013779



Insert label, Strip, white, unlabeled, can be labeled with: CMS-P1-PLOTTER, mounting type: thread on, cable diameter range: 1.5 ... 35 mm, lettering field size: 23 x 4 mm, Number of individual labels: 20

Insert label - PABA YE/23 - 1013782



Insert label, Strip, yellow, unlabeled, can be labeled with: CMS-P1-PLOTTER, mounting type: thread on, cable diameter range: 1.5 ... 35 mm, lettering field size: 23 x 4 mm, Number of individual labels: 20

Marker pen

Marker pen - B-STIFT - 1051993



Marker pen, for manual labeling of unprinted Zack strips, smear-proof and waterproof, line thickness 0.5 mm

Plug for cable screw gland

Screw plug - PROT-M 8 MS-PA-CHAIN - 1430860

M8 sealing cap made of plastic with fixing band for sensor cables, for M8 sockets



Protective cap

Sensor/actuator cable - SAC-4P-M12MS/3,0-PVC/M 8FS - 1415674

Accessories

Sealing cap - PROT-M12 FS-PA-CHAIN - 1430873

M12 sealing cap made of plastic with fixing band, for sensor cables, for free M12 plugs



Safety locking

Locking clip - SAC-M12-EXCLIP-M - 1558988



Locking clip for the pin side of sensor/actuator cables with M12 connector and M12 connectors for assembly, for knurl diameter: 15 mm or for Allen key with a wrench size of 14 mm, prevents the disconnection of plug-in connections without tools

Screwdriver tools

Tool - SAC BIT M8-D10 - 1208461



Nut for assembling M8 connectors with longitudinal knurl and a knurl diameter of 10 mm, for 4 mm hexagonal drive

Adapter insert - TSD-M SAC-BIT ADAPTER - 1212600



Adapter bit for TSD-M...torque tools, E6.3-1/4" drive with 4 mm hexagon to accommodate SAC bits

Tool - SAC BIT M12-D15 - 1208432



Nut for assembling sensor/actuator cables with M12 connector and M12 connectors for assembly, with a knurl diameter of 15 mm, for 4 mm hexagonal drive

Torque tool

Sensor/actuator cable - SAC-4P-M12MS/3,0-PVC/M 8FS - 1415674

Accessories

Torque screwdriver - TSD 02 SAC - 1208487



Torque screwdriver, with preset torque of 0.2 Nm and 4 mm hexagonal drive for M8 connectors

Torque screwdriver - TSD 04 SAC - 1208429



Torque screwdriver, with preset torque of 0.4 Nm and 4 mm hexagonal drive for M12 connectors

Torque screwdriver - TSD-M 1,2NM - 1212224



Torque screw driver, accuracy as per EN ISO 6789 standard, adjustable from 0.3 - 1.2 Nm

Phoenix Contact 2020 © - all rights reserved
<http://www.phoenixcontact.com>

PHOENIX CONTACT GmbH & Co. KG
Flachsmarktstr. 8
32825 Blomberg
Germany
Tel. +49 5235 300
Fax +49 5235 3 41200
<http://www.phoenixcontact.com>

X-ON Electronics

Largest Supplier of Electrical and Electronic Components

Click to view similar products for [Sensor Cables / Actuator Cables](#) category:

Click to view products by [Phoenix Contact](#) manufacturer:

Other Similar products are found below :

[60963](#) [60964](#) [703000D02F2002](#) [703001D02F0602](#) [703001D02F300](#) [704000D02F120](#) [773032K02F030](#) [802027107404-1](#) [802027213811-1](#)
[804001A09M150](#) [805001A09M0502](#) [84914-0235](#) [84914-0237](#) [885030A09M020](#) [8R4J30E03C3003](#) [1200651332](#) [1200651713](#) [1200660844](#)
[1200660845](#) [1200661173](#) [1200680071](#) [1200720053](#) [1200720081](#) [1200720099](#) [1200720217](#) [1200800231](#) [1200860125](#) [1200870123](#)
[1200980102](#) [1200650267](#) [1200650298](#) [1200660183](#) [1200660782](#) [1200660849](#) [1200661295](#) [1200661297](#) [1200661342](#) [1200661343](#)
[1200670080](#) [1200670220](#) [1200680331](#) [1200720252](#) [1200730184](#) [1200860344](#) [1200870359](#) [1200870643](#) [1200980008](#) [1200980031](#)
[1210502211](#) [1210400542](#)