

Sensor/actuator cable - SAC-3P- 1,5-PVC/M 8FR - 1415872

Please be informed that the data shown in this PDF Document is generated from our Online Catalog. Please find the complete data in the user's documentation. Our General Terms of Use for Downloads are valid (<http://phoenixcontact.com/download>)



Sensor/actuator cable, 3-position, PVC, black RAL 9005, free cable end, on Socket angled M8, cable length: 1.5 m

Your advantages

- ✔ Easy and safe: 100% electrically tested plug-in components

Key Commercial Data

| | |
|--------------|---|
| Packing unit | 1 pc |
| GTIN |  4 055626 054445 |
| GTIN | 4055626054445 |

Technical data

Dimensions

| | |
|-----------------|-------|
| Length of cable | 1.5 m |
|-----------------|-------|

Ambient conditions

| | |
|---------------------------------|----------------------------------|
| Ambient temperature (operation) | -25 °C ... 90 °C (Plug / socket) |
| Degree of protection | IP65 |
| | IP67 |
| | IP68 |

General

| | |
|-----------------------|------------------------------|
| Rated current at 40°C | 4 A |
| Rated voltage | 48 V AC |
| | 60 V DC |
| Number of positions | 3 |
| Insulation resistance | ≥ 100 MΩ |
| Coding | A - standard |
| Standards/regulations | M8 connector IEC 61076-2-104 |

Sensor/actuator cable - SAC-3P- 1,5-PVC/M 8FR - 1415872

Technical data

General

| | |
|------------------------------|---------|
| Status display | No |
| Protective circuit/component | unwired |
| Overtoltage category | II |
| Degree of pollution | 3 |
| Insertion/withdrawal cycles | ≥ 100 |

Material

| | |
|--|---|
| Flammability rating according to UL 94 | HB |
| Contact material | CuSn |
| Contact surface material | Ni/Au |
| Contact carrier material | TPU GF |
| Material of grip body | TPU, hardly inflammable, self-extinguishing |
| Material, knurls | Zinc die-cast, nickel-plated |
| Sealing material | NBR |

Standards and Regulations

| | |
|--|------------------------------|
| Standards/specifications | M8 connector IEC 61076-2-104 |
| Flammability rating according to UL 94 | HB |

Cable

| | |
|------------------------------------|---------------------------------------|
| Cable type | PVC black |
| Cable type (abbreviation) | PVC |
| Cable abbreviation | LiYY |
| Conductor cross section | 3x 0.25 mm ² (Signal line) |
| AWG signal line | 24 |
| Conductor structure signal line | 14x 0.15 mm |
| Core diameter including insulation | 1.17 mm ±0.05 mm |
| Thickness, insulation | ≥ 0.23 mm (Core insulation) |
| Wire colors | brown, blue, black |
| Overall twist | 3 wires, twisted |
| External sheath, color | black RAL 9005 |
| Outer sheath thickness | ≥ 0.76 mm |
| External cable diameter D | 4.2 mm ±0.15 mm |
| Cable weight | 29 kg/km |
| Outer sheath, material | PVC |
| Material conductor insulation | PVC |
| Conductor material | Bare Cu litz wires |
| Insulation resistance | ≥ 100 MΩ*km (at 20 °C) |
| Conductor resistance | max. 79 Ω/km (at 20 °C) |
| Nominal voltage, cable | ≥ 300 V |
| Test voltage, cable | ≤ 3000 V |
| Flame resistance | As per UL-Style 2464 |

Sensor/actuator cable - SAC-3P- 1,5-PVC/M 8FR - 1415872

Technical data

Cable

| | |
|---------------------------------|---|
| Ambient temperature (operation) | -40 °C ... 80 °C (cable, fixed installation) |
| | -25 °C ... 80 °C (cable, flexible installation) |

Environmental Product Compliance

| | |
|------------|---|
| China RoHS | Environmentally friendly use period: unlimited = EFUP-e |
| | No hazardous substances above threshold values |

Drawings

Dimensional drawing

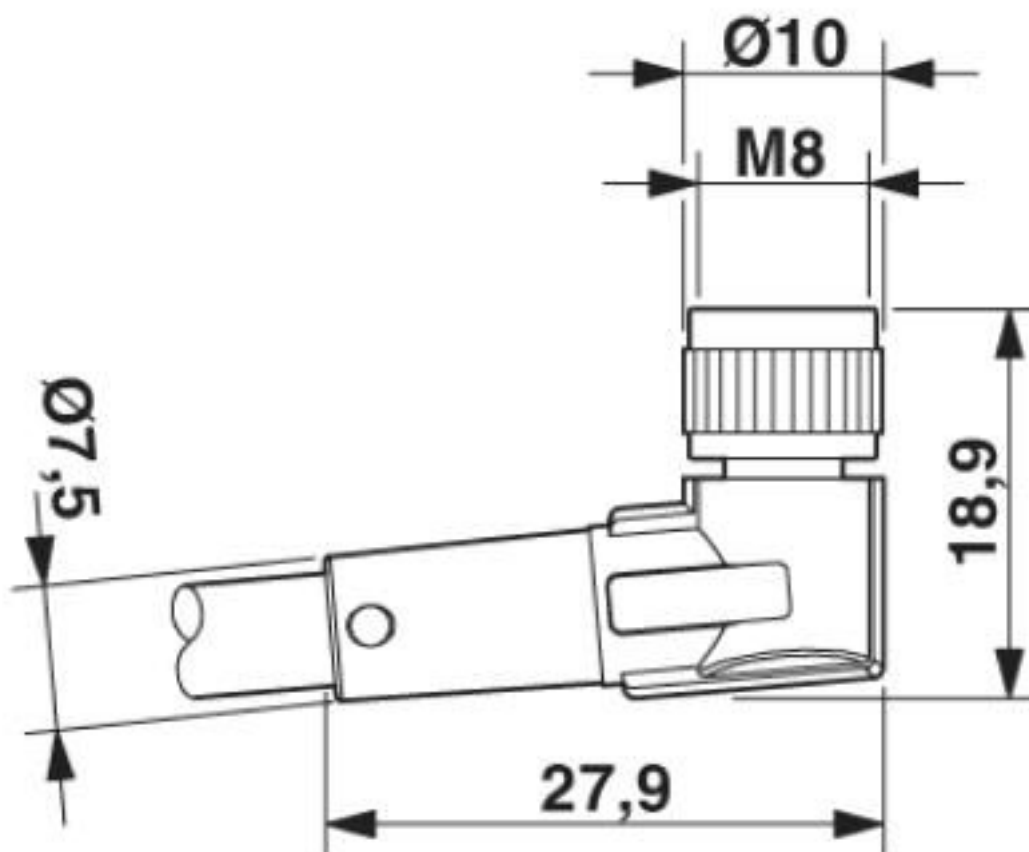

Socket M8 x 1, angled

Sensor/actuator cable - SAC-3P- 1,5-PVC/M 8FR - 1415872

Circuit diagram

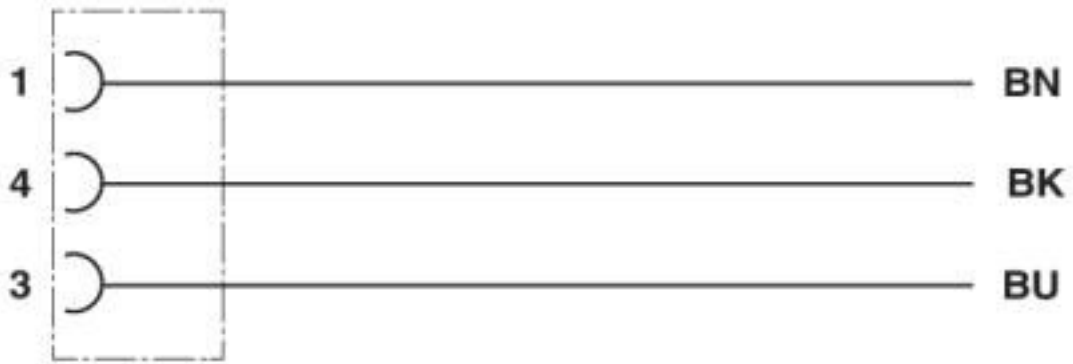

Contact assignment of M8 plugs/sockets

Schematic diagram

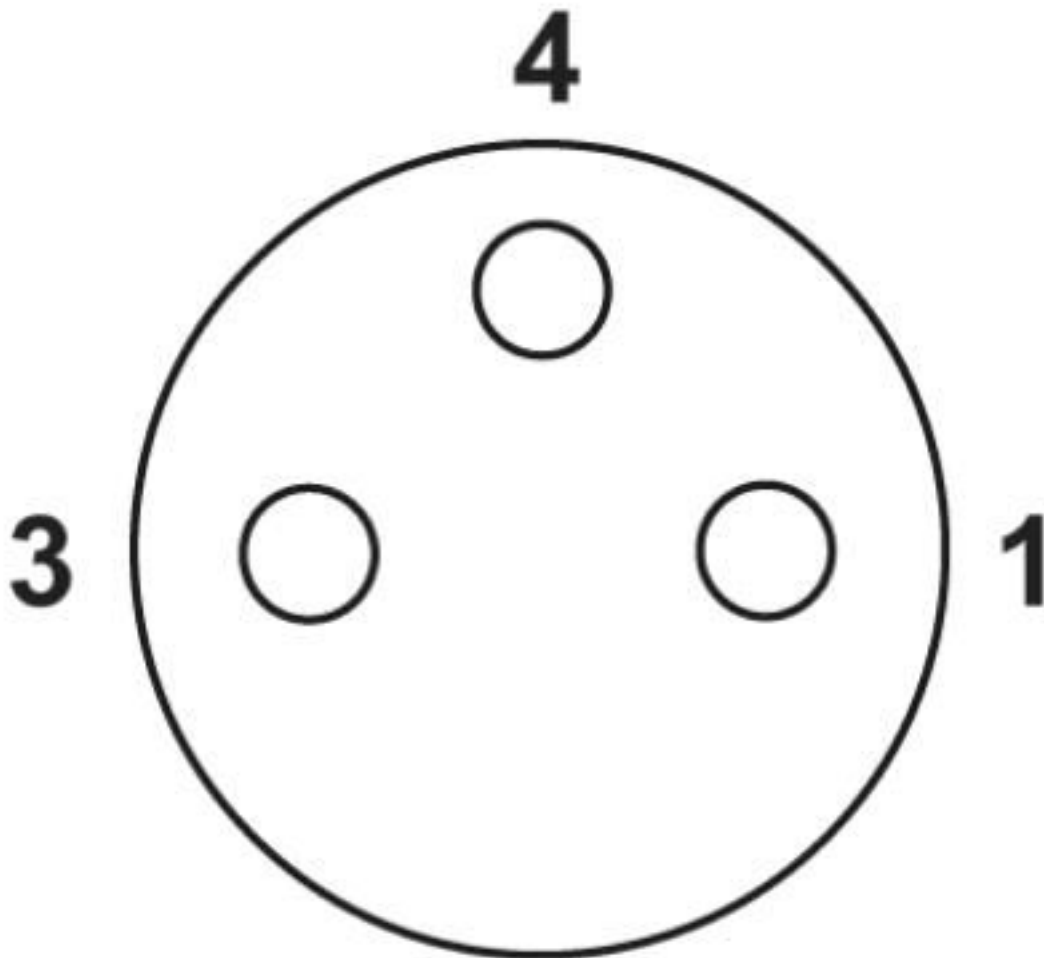

Pin assignment M8 socket, 3-pos., view female side

Sensor/actuator cable - SAC-3P- 1,5-PVC/M 8FR - 1415872

Cable cross section

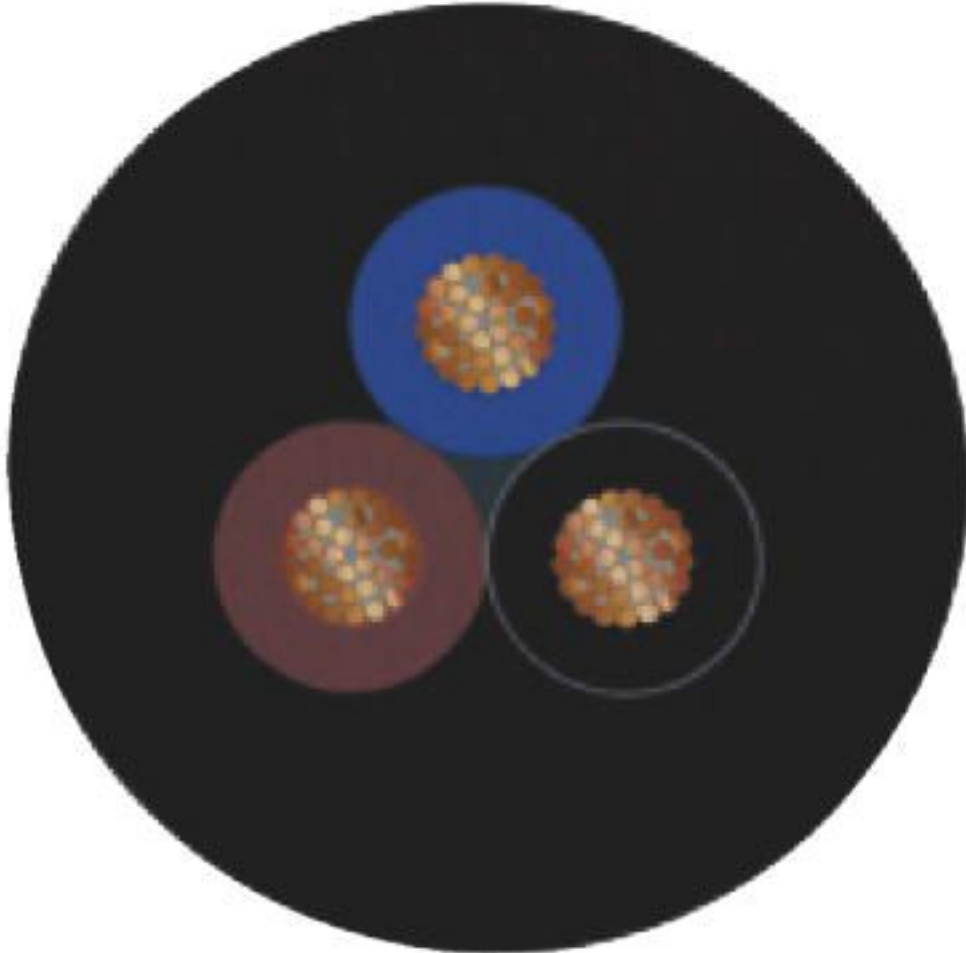

PVC black [PVC]

Classifications

eCl@ss

| | |
|---------------|----------|
| eCl@ss 10.0.1 | 27060311 |
| eCl@ss 4.0 | 27060300 |
| eCl@ss 4.1 | 27060300 |
| eCl@ss 5.0 | 27061800 |
| eCl@ss 5.1 | 27061800 |
| eCl@ss 6.0 | 27279200 |
| eCl@ss 7.0 | 27279218 |
| eCl@ss 8.0 | 27279218 |
| eCl@ss 9.0 | 27060311 |

Sensor/actuator cable - SAC-3P- 1,5-PVC/M 8FR - 1415872

Classifications

ETIM

| | |
|----------|----------|
| ETIM 5.0 | EC001855 |
| ETIM 6.0 | EC001855 |
| ETIM 7.0 | EC001855 |

UNSPSC

| | |
|-------------|----------|
| UNSPSC 13.2 | 31251501 |
| UNSPSC 19.0 | 31251501 |
| UNSPSC 20.0 | 31251501 |
| UNSPSC 21.0 | 31251501 |

Approvals

Approvals

Approvals

UL Listed / cUL Listed / EAC-RoHS / EAC / cULus Listed

Ex Approvals

Approval details

| | | | |
|--------------------|---|---|---------------|
| UL Listed |  | http://database.ul.com/cgi-bin/XYV/template/LISEXT/1FRAME/index.htm | FILE E 221474 |
| Nominal voltage UN | 60 V | | |
| Nominal current IN | 4 A | | |

| | | | |
|--------------------|---|---|---------------|
| cUL Listed |  | http://database.ul.com/cgi-bin/XYV/template/LISEXT/1FRAME/index.htm | FILE E 221474 |
| Nominal voltage UN | 60 V | | |
| Nominal current IN | 4 A | | |

| | | |
|----------|---|----------------------|
| EAC-RoHS |  | RU D-DE.HB35.B.00387 |
|----------|---|----------------------|

Sensor/actuator cable - SAC-3P- 1,5-PVC/M 8FR - 1415872

Approvals

| | | |
|-----|--|--------------------------|
| EAC | | RU C- DE.BL08.B.00286 |
|-----|--|--------------------------|

| | |
|--------------|--|
| cULus Listed | |
|--------------|--|

Accessories

Accessories

Conductor marking

Insert label - PABA WH/23 - 1013779



Insert label, Strip, white, unlabeled, can be labeled with: CMS-P1-PLOTTER, mounting type: thread on, cable diameter range: 1.5 ... 35 mm, lettering field size: 23 x 4 mm, Number of individual labels: 20

Insert label - PABA YE/23 - 1013782



Insert label, Strip, yellow, unlabeled, can be labeled with: CMS-P1-PLOTTER, mounting type: thread on, cable diameter range: 1.5 ... 35 mm, lettering field size: 23 x 4 mm, Number of individual labels: 20

Corrugated pipe

Protective hose - WP-PA HF 13,0 BK - 3240681



Polyamide protective hose, inflammability class V0, UV resistant

Protective hose - WP-PA HF-HB 13,0 BK - 3240839



Polyamide protective hose, inflammability class HB, UV resistant

Sensor/actuator cable - SAC-3P- 1,5-PVC/M 8FR - 1415872

Accessories

Cutting tools

Diagonal cutter - CUTFOX-S VDE - 1212207



Diagonal cutter for hard (piano wire) and soft wires, VDE 1000 V AC/1500 V DC tested

Marker pen

Marker pen - B-STIFT - 1051993



Marker pen, for manual labeling of unprinted Zack strips, smear-proof and waterproof, line thickness 0.5 mm

Plug for cable screw gland

Screw plug - PROT-M 8 MS-PA-CHAIN - 1430860



M8 sealing cap made of plastic with fixing band for sensor cables, for M8 sockets

Screwdriver tools

Tool - SAC BIT M8-D10 - 1208461



Nut for assembling M8 connectors with longitudinal knurl and a knurl diameter of 10 mm, for 4 mm hexagonal drive

Tool - SAC BIT M8-D10 - 1208461



Nut for assembling M8 connectors with longitudinal knurl and a knurl diameter of 10 mm, for 4 mm hexagonal drive

Sensor/actuator cable - SAC-3P- 1,5-PVC/M 8FR - 1415872

Accessories

Stripping tool

Stripping tool - WIREFOX SAC-1 - 1212757



Stripping pliers, for halogen-free sensor/actuator cables (SAC cables), with PUR and PVC insulation, from Ø of 3.2 to 4.4 mm, any stripping length

Stripping tool - WIREFOX SAC - 1212623



Stripping pliers, for halogen-free sensor/actuator cables (SAC cables), with PUR and PVC insulation, from Ø of 4.4 to 7 mm, any stripping length

Stripping tool - WIREFOX 10 - 1212150



Stripping tool, for cables and conductors from 0.02 - 10 mm², self-adjusting, stripping length of up to 18 mm, cutting capacity of up to 10 mm² stranded/1.5 mm² solid, replaceable stripping blade

Torque tool

Torque screwdriver - TSD 02 SAC - 1208487



Torque screwdriver, with preset torque of 0.2 Nm and 4 mm hexagonal drive for M8 connectors

Torque screwdriver - TSD 02 SAC - 1208487



Torque screwdriver, with preset torque of 0.2 Nm and 4 mm hexagonal drive for M8 connectors

Sensor/actuator cable - SAC-3P- 1,5-PVC/M 8FR - 1415872

Accessories

Protective hose adapter - WP-CTA POM 13,0 BK - 1422884



Protective hose adapter, for corrugated hoses with a nominal size of 13 (10 x 13), corrugated in parallel

Phoenix Contact 2020 © - all rights reserved
<http://www.phoenixcontact.com>

PHOENIX CONTACT GmbH & Co. KG
Flachsmarktstr. 8
32825 Blomberg
Germany
Tel. +49 5235 300
Fax +49 5235 3 41200
<http://www.phoenixcontact.com>

X-ON Electronics

Largest Supplier of Electrical and Electronic Components

Click to view similar products for [Sensor Cables / Actuator Cables](#) category:

Click to view products by [Phoenix Contact](#) manufacturer:

Other Similar products are found below :

[60963](#) [60964](#) [703000D02F2002](#) [703001D02F0602](#) [703001D02F300](#) [704000D02F120](#) [773032K02F030](#) [802027107404-1](#) [802027213811-1](#)
[804001A09M150](#) [805001A09M0502](#) [84914-0235](#) [84914-0237](#) [885030A09M020](#) [8R4J30E03C3003](#) [1200651332](#) [1200651713](#) [1200660844](#)
[1200660845](#) [1200661173](#) [1200680071](#) [1200720053](#) [1200720081](#) [1200720099](#) [1200720217](#) [1200800231](#) [1200860125](#) [1200870123](#)
[1200980102](#) [1200650267](#) [1200650298](#) [1200660183](#) [1200660782](#) [1200660849](#) [1200661295](#) [1200661297](#) [1200661342](#) [1200661343](#)
[1200670080](#) [1200670220](#) [1200680331](#) [1200720252](#) [1200730184](#) [1200860344](#) [1200870359](#) [1200870643](#) [1200980008](#) [1200980031](#)
[1210502211](#) [1210400542](#)