

# Network cable - VS-M12MS-IP20-93R-LI/2,0 - 1416242

Please be informed that the data shown in this PDF Document is generated from our Online Catalog. Please find the complete data in the user's documentation. Our General Terms of Use for Downloads are valid (<http://phoenixcontact.com/download>)



Network cable, PROFINET CAT5 (100 Mbps), 4-position, PUR, green RAL 6018, Plug straight M12 / IP67, coding: D, on Plug straight RJ45 / IP20, cable length: 2 m



RoHS

## Key Commercial Data

Packing unit	1 pc
GTIN	 4 046356 473385
GTIN	4046356473385

## Technical data

### Dimensions

Length of cable	2 m
-----------------	-----

### Ambient conditions

Degree of protection	IP65 (M12 connector)
	IP20 (RJ45 connector)

### General data

Rated voltage	48 V AC
	60 V DC
Number of positions	4
Signal type/category	PROFINET CAT5 (IEC 11801), 100 Mbps
Transmission characteristics (category)	CAT5

### Characteristics head 1

Head type	Plug straight M12 / IP67
No. of positions (pin connector pattern)	4
Coding	D (Data)
Color	black
Shielded	yes

# Network cable - VS-M12MS-IP20-93R-LI/2,0 - 1416242

## Technical data

### Characteristics head 1

Outer sheath, material	PUR
External sheath, color	green RAL 6018

### Characteristics head 2

Head type	Plug straight RJ45 / IP20
No. of positions (pin connector pattern)	4
Color	gray

### Cable

Cable type	PROFINET robot CAT5
Cable type (abbreviation)	93R
UL AWM style	20233 (80°C/300 V)
Signal type/category	PROFINET CAT5 (IEC 11801), 100 Mbps
	EtherCAT® CAT5 (IEC 11801), 100 Mbps
Cable structure	1x4xAWG22/19; S/TQ
Conductor cross section	4x 0.34 mm <sup>2</sup>
AWG signal line	22
Conductor structure signal line	19x 0.15 mm
Core diameter including insulation	1.5 mm
Wire colors	White, yellow, blue, orange
Overall twist	Star quad
Shielding	Tinned copper braided shield
Optical shield covering	85 %
External sheath, color	green RAL 6018
Outer sheath thickness	approx. 1 mm
External cable diameter D	6.5 mm ±0.2 mm
Minimum bending radius, fixed installation	5 x D
Torsion force	± 180 °/m (1 000 000 torsion cycles)
Cable weight	55 kg/km
Outer sheath, material	PUR
Material conductor insulation	Foamed PE
Conductor material	Tin-plated Cu litz wires
Insulation resistance	≥ 500 MΩ*km
Loop resistance	≤ 120.00 Ω/km
Wave impedance	100 Ω ±5 Ω (at 100 MHz)
Attenuation	2.9 dB (with 1 MHz)
	5 dB (at 4 MHz)
	8.1 dB (at 10 MHz)
	10.4 dB (at 16 MHz)
	11.9 dB (at 20 MHz)
	15.5 dB (at 31.25 MHz)
	26.5 dB (at 62.5 MHz)

# Network cable - VS-M12MS-IP20-93R-LI/2,0 - 1416242

## Technical data

### Cable

	41 dB (at 100 MHz)
Signal runtime	4.8 ns/m
Nominal voltage, cable	300 V
Test voltage Core/Core	2000 V (50 Hz, 1 min.)
Test voltage Core/Shield	2000 V (50 Hz, 1 min.)
Flame resistance	according to IEC 60332-1-2
Halogen-free	according to IEC 60754-1
Resistance to oil	in accordance with DIN EN 60811-2-1
Other resistance	UV resistant According to UL 1581, Section 1200
Ambient temperature (operation)	-40 °C ... 80 °C
	-40 °C ... 80 °C
Ambient temperature (installation)	-20 °C ... 60 °C
Ambient temperature (storage/transport)	-40 °C ... 80 °C

### Environmental Product Compliance

China RoHS	Environmentally friendly use period: unlimited = EFUP-e
	No hazardous substances above threshold values

## Drawings

Dimensional drawing

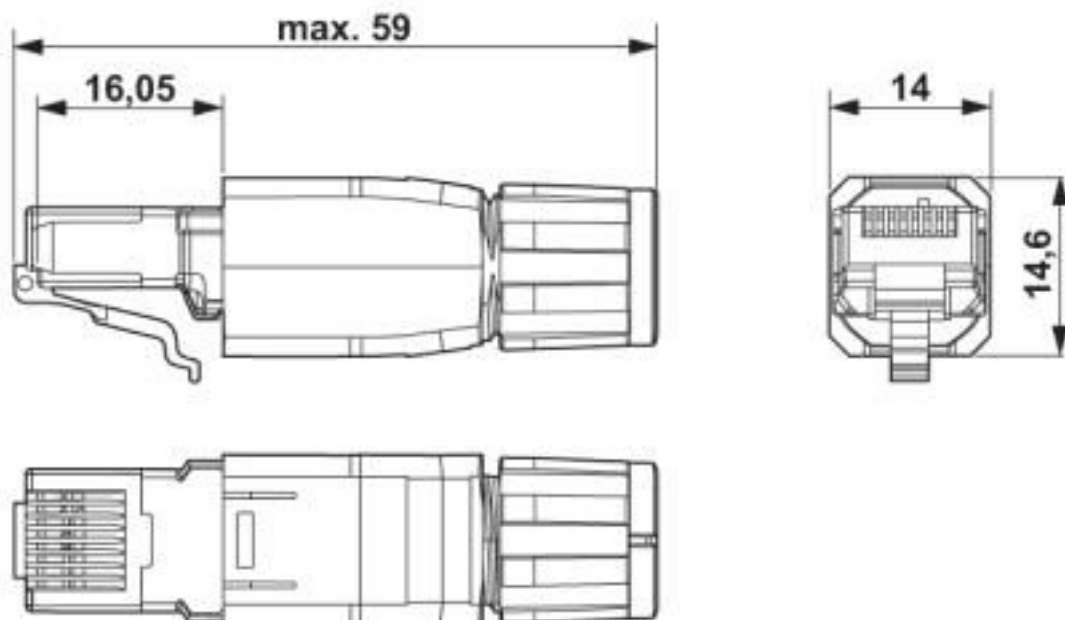

RJ45 connector, IP20

# Network cable - VS-M12MS-IP20-93R-LI/2,0 - 1416242

Dimensional drawing

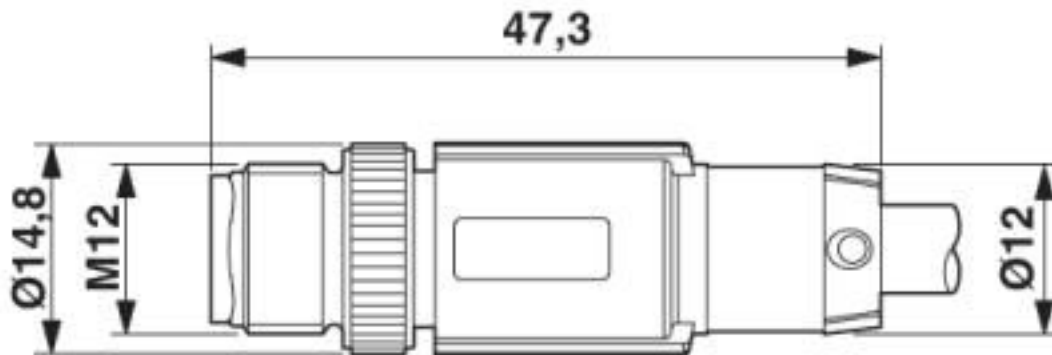

Plug, M12 x 1, straight, shielded

Circuit diagram

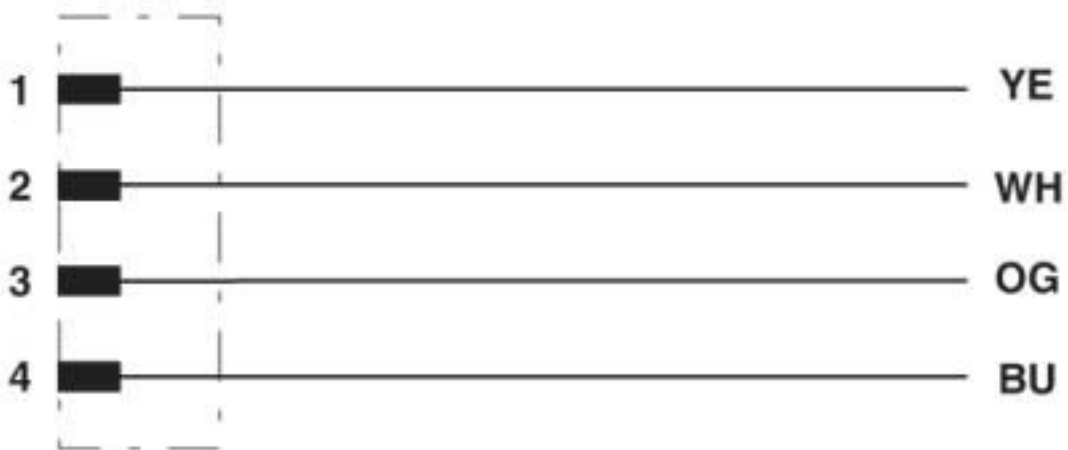

Contact assignment of the M12 connector

# Network cable - VS-M12MS-IP20-93R-LI/2,0 - 1416242

Schematic diagram

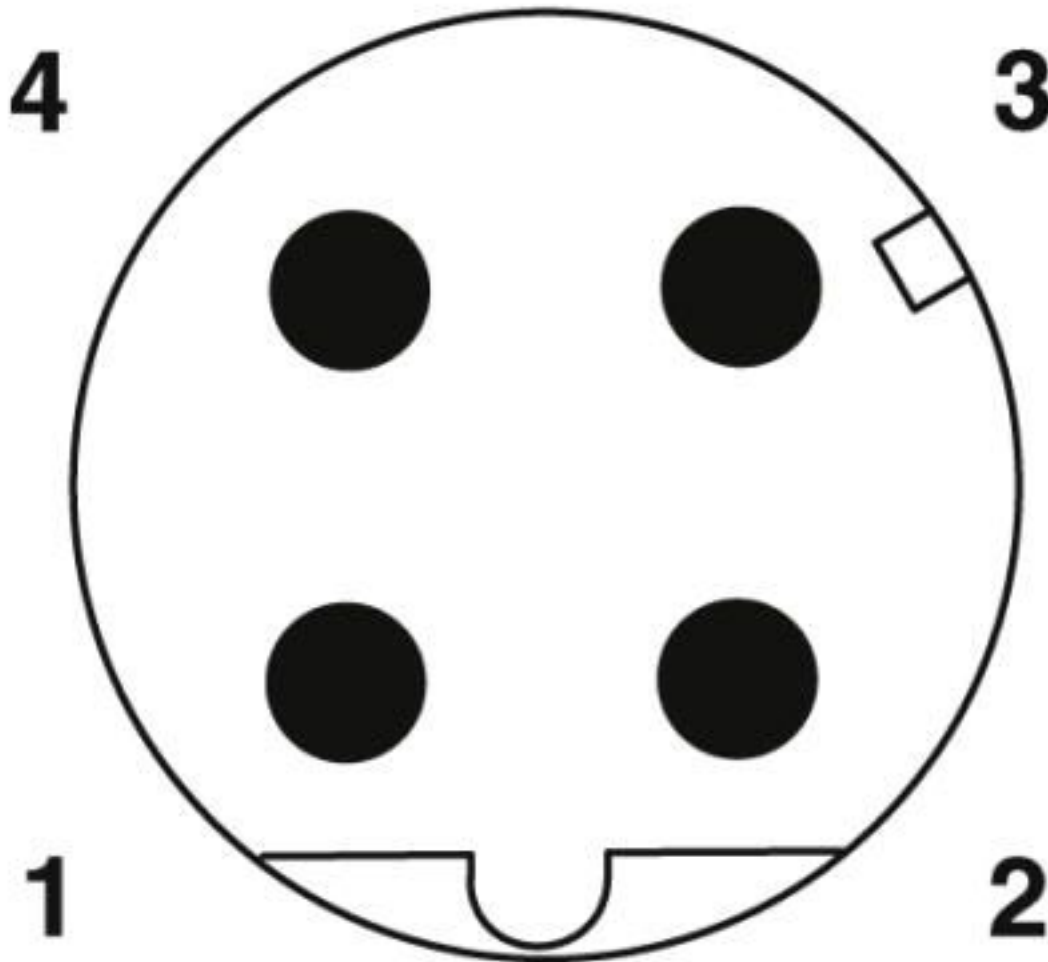

Pin assignment M12 male connector, 4-pos., D-coded, male side

# Network cable - VS-M12MS-IP20-93R-LI/2,0 - 1416242

Cable cross section

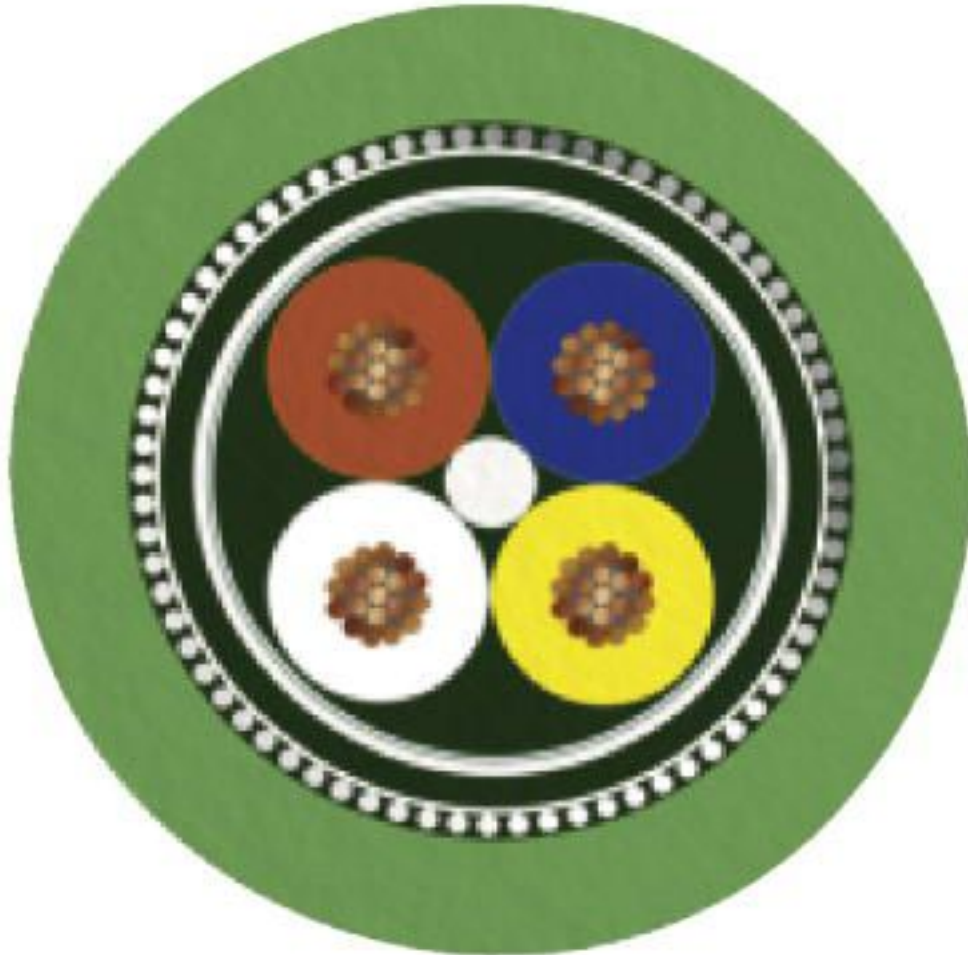

PROFINET robot CAT5 [93R]

## Classifications

eCl@ss

eCl@ss 10.0.1	27060308
eCl@ss 4.0	24010400
eCl@ss 4.1	24010400
eCl@ss 5.0	19030300
eCl@ss 5.1	19030300
eCl@ss 6.0	27061800
eCl@ss 7.0	27061801
eCl@ss 8.0	27061801
eCl@ss 9.0	27060308

# Network cable - VS-M12MS-IP20-93R-LI/2,0 - 1416242

## Classifications

### ETIM

ETIM 4.0	EC002599
ETIM 5.0	EC002599
ETIM 6.0	EC001262
ETIM 7.0	EC001262

### UNSPSC

UNSPSC 6.01	31261501
UNSPSC 7.0901	31261501
UNSPSC 11	31261501
UNSPSC 12.01	31261501
UNSPSC 13.2	26121604
UNSPSC 18.0	26121604
UNSPSC 19.0	26121604
UNSPSC 20.0	26121604
UNSPSC 21.0	26121604

## Approvals

### Approvals

---

Approvals

EAC-RoHS

---

Ex Approvals

---

### Approval details

EAC-RoHS		RU D- DE.HB35.B.00385
----------	---	--------------------------

---

Phoenix Contact 2020 © - all rights reserved  
<http://www.phoenixcontact.com>

PHOENIX CONTACT GmbH & Co. KG  
Flachsmarktstr. 8  
32825 Blomberg  
Germany  
Tel. +49 5235 300  
Fax +49 5235 3 41200  
<http://www.phoenixcontact.com>

## X-ON Electronics

Largest Supplier of Electrical and Electronic Components

*Click to view similar products for [Ethernet Cables / Networking Cables](#) category:*

*Click to view products by [Phoenix Contact](#) manufacturer:*

Other Similar products are found below :

[73-6670-7](#) [73-6680-15](#) [73-7797-25](#) [MCJB2-10P6Q7-120](#) [84909-0204](#) [1200700174](#) [1200860368](#) [E16A06002M030](#) [E200102-009-S1](#)  
[AX105346-EW](#) [MT14-187L](#) [17-103530](#) [ERWPAB3002M005](#) [190-038045-01](#) [NK5EPC18RDY](#) [NK5EPC18VLY](#) [NK5EPC18YLY](#)  
[NK5EPC1GRY](#) [NK5EPC4Y](#) [NK5EPC6YLY](#) [NK5EPC8BLY](#) [NK5EPC9YLY](#) [1969343-6](#) [C501100010](#) [C501106002](#) [C501106007](#)  
[C501106015](#) [C501106025](#) [C601102010](#) [C601104010](#) [C601106007](#) [C601106015](#) [2142758-2](#) [2168427-2](#) [CAT1106007](#) [21949-1](#) [2J1866A](#)  
[RJF SFTP 5E 0500](#) [AX100351](#) [MN14CEC/ST](#) [C501100015](#) [C501106004](#) [C501106010](#) [C5F1108007](#) [C601104004](#) [C601106004](#)  
[CA21106004](#) [CA21106010](#) [CA21106015](#) [CA21109007](#)