

Connector set - HC-STA-B10PT-BWD-LT-M25-ELCAL - 1416346

Please be informed that the data shown in this PDF Document is generated from our Online Catalog. Please find the complete data in the user's documentation. Our General Terms of Use for Downloads are valid (<http://phoenixcontact.com/download>)



Connector set, number of positions: 10, material: Die-cast aluminum, salt water resistant, connection method: Push-in connection, connection cross section: AWG 26- 14



Key Commercial Data

Packing unit	1 pc
GTIN	 4 055626 069890
GTIN	4055626069890
Weight per Piece (excluding packing)	0.467 kg
Custom tariff number	85366990
Country of origin	China
Note	Made to Order (non-returnable)

Technical data

General

Number of positions	10+PE
Type	B10
Connection method	Push-in connection
Degree of protection for housing	IP66
	IP67
	4 (UL 50e)
	4X (UL 50e)
	12 (UL 50e)
Connection method	Push-in connection
Rated voltage (III/3)	500 V
Rated surge voltage	6 kV
Rated current	16 A

Connector set - HC-STA-B10PT-BWD-LT-M25-ELCAL - 1416346

Technical data

General

Conductor cross section	0.14 mm ² ... 2.5 mm ² (with ferrule)
Connection cross section AWG	26 ... 14
External cable diameter	11 mm ... 17 mm
Ambient temperature (operation)	-40 °C ... 100 °C
Length of the assembly cutout	65 mm
Width of the assembly cutout	35 mm
Housing material	Die-cast aluminum, salt water resistant
Contact carrier material	PC
Locking latch material	PA
Integrated protective cover	no

Standards and Regulations

Flammability rating according to UL 94	V0
--	----

Environmental Product Compliance

China RoHS	Environmentally Friendly Use Period = 50
	For details about hazardous substances go to tab "Downloads", Category "Manufacturer's declaration"

Drawings

Connector set - HC-STA-B10PT-BWD-LT-M25-ELCAL - 1416346

Schematic diagram

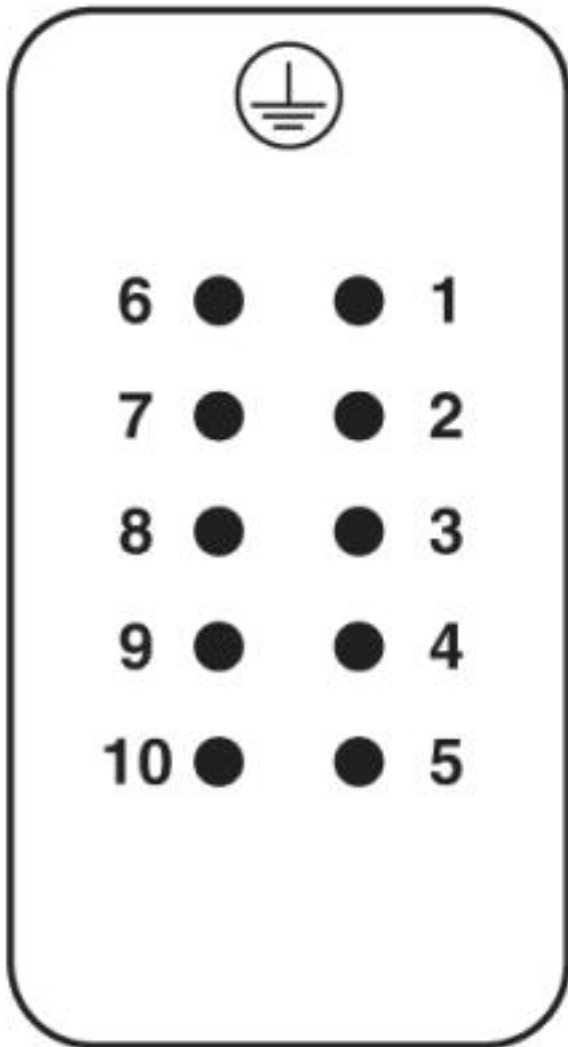

Pin assignment, connection side, pin

Schematic diagram

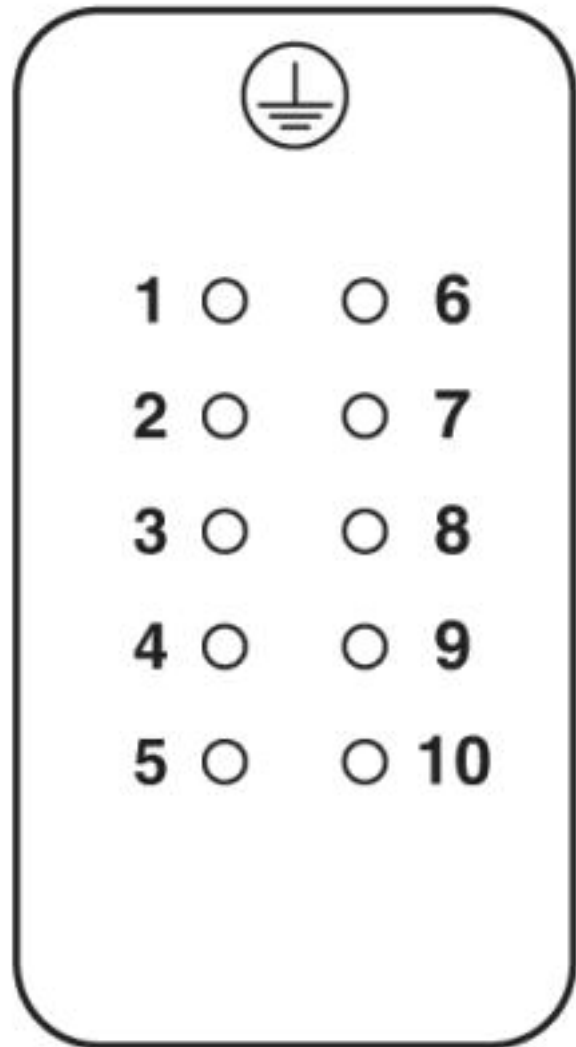

Pin assignment, connection side, socket

Connector set - HC-STA-B10PT-BWD-LT-M25-ELCAL - 1416346

Diagram

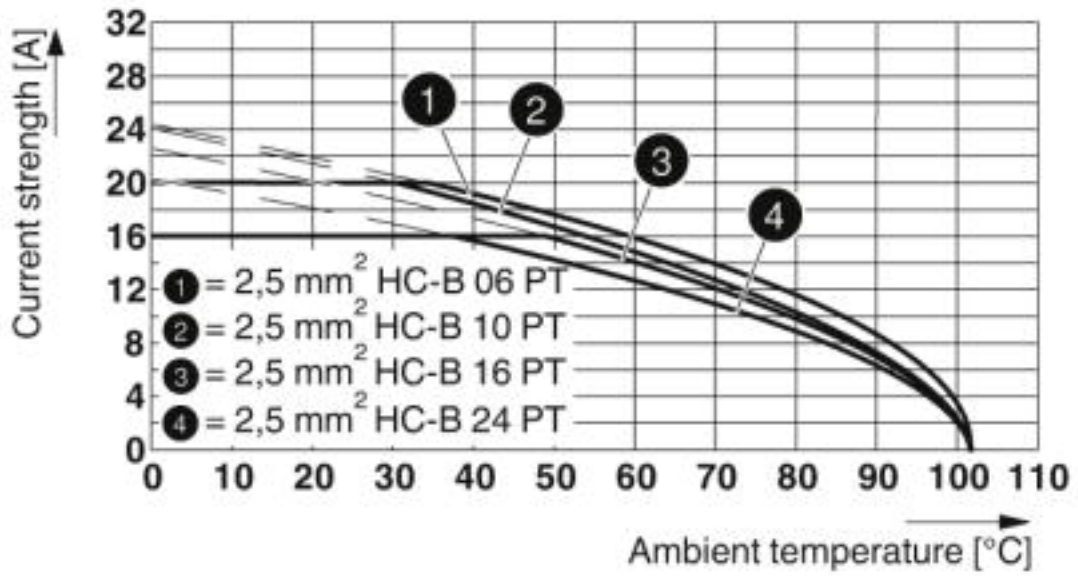

Derating diagram

Connector set - HC-STA-B10PT-BWD-LT-M25-ELCAL - 1416346

Dimensional drawing

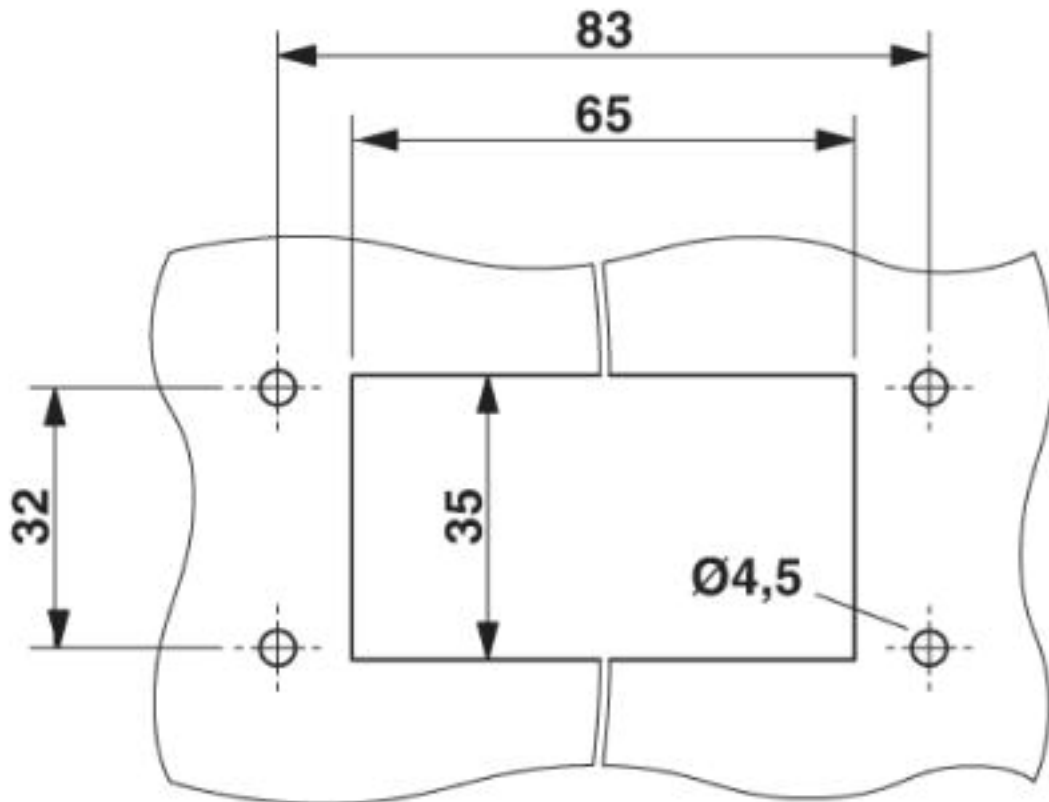

Mounting cutout

Connector set - HC-STA-B10PT-BWD-LT-M25-ELCAL - 1416346

Dimensional drawing

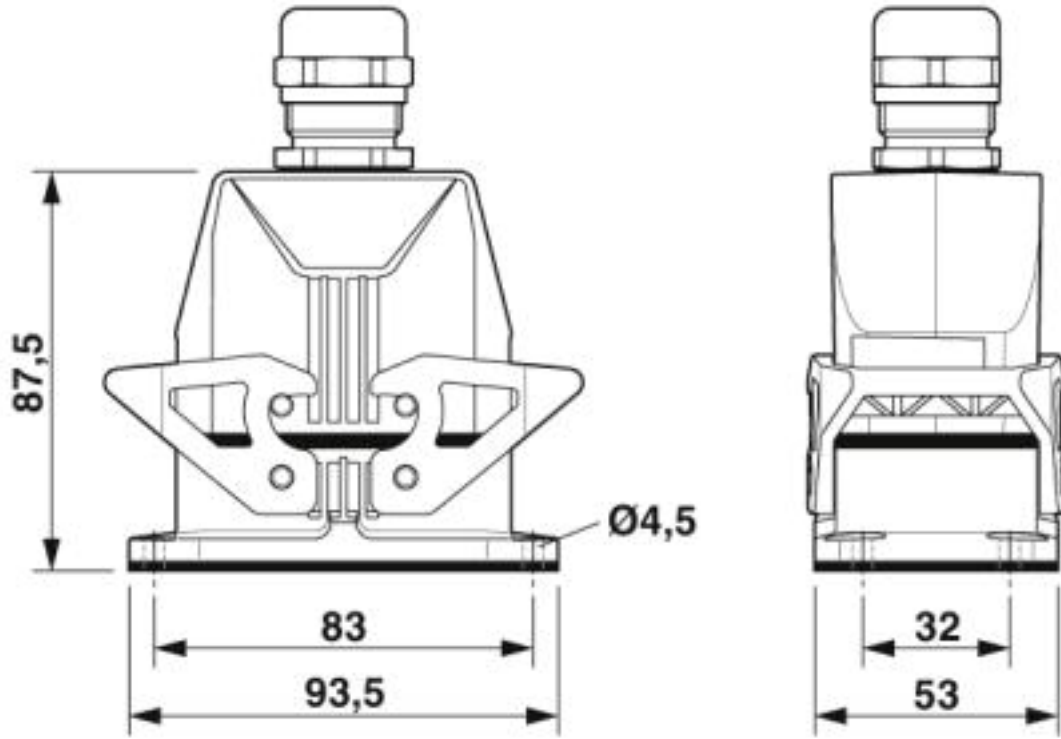

Dimensional drawing

Articles in set

Contact insert - HC-B10-I-PT-F - 1407729



HEAVYCON socket insert, B10 series, 10 + PE-pos., push-in connection

Contact insert - HC-B10-I-PT-M - 1407730



HEAVYCON pin insert, B10 series, 10 + PE-pos., push-in connection

Connector set - HC-STA-B10PT-BWD-LT-M25-ELCAL - 1416346

Articles in set

Housing - HC-STA-B10-BWD-ELC-AL - 1411322



HEAVYCON B10 panel mounting base, with double locking latch, with flat gasket, salt-water-resistant aluminum, conductive profile gasket

Housing - HC-STA-B10-HLFD-1TTM25-EL-AL - 1412621



Sleeve housing B10, for double locking latch, material: Die-cast aluminum, salt water resistant, cable outlets: 1, straight, height: 57 mm, cable gland: none, support sleeve: no, 1x M25, Standard

Cable gland - G-INS-M25-M68N-NNES-S - 1411165



Cable gland, cable gland material: Nickel-plated brass, external cable diameter 11 mm ... 17 mm, shielding: no, connecting thread: M25 x 1.5, color: silver, with O-ring

Classifications

eCl@ss

eCl@ss 4.0	27260700
eCl@ss 4.1	27260700
eCl@ss 5.0	27260700
eCl@ss 5.1	27260700
eCl@ss 6.0	27260700
eCl@ss 7.0	27440101
eCl@ss 8.0	27440101
eCl@ss 9.0	27440101

ETIM

ETIM 5.0	EC002636
ETIM 6.0	EC002636
ETIM 7.0	EC002636

UNSPSC

UNSPSC 13.2	39121409
-------------	----------

Connector set - HC-STA-B10PT-BWD-LT-M25-ELCAL - 1416346

Approvals

Approvals

Approvals

EAC / DNV GL

Ex Approvals

Approval details

EAC			RU C- DE.AI30.B.01102
-----	---	--	--------------------------

DNV GL		https://approvalfinder.dnvgl.com/	TAE000037S
--------	--	---	------------

X-ON Electronics

Largest Supplier of Electrical and Electronic Components

Click to view similar products for [Heavy Duty Power Connectors](#) category:

Click to view products by [Phoenix Contact](#) manufacturer:

Other Similar products are found below :

[1424439](#) [1424438](#) [09330062652](#) [2-8675P1](#) [580129-2](#) [605601-1](#) [6340G1](#) [6341G1](#) [6360G1](#) [6373G1](#) [6374g2](#) [6396G1](#) [647757-1](#) [66394-4](#)
[6643411-1](#) [6646058-2](#) [6646137-1](#) [6646138-1](#) [6646348-1](#) [6646479-1](#) [6646608-1](#) [6646786-1](#) [6646940-1](#) [6651091-1](#) [6651525-1](#) [6651529-1](#)
[6651778-1](#) [6651788-1](#) [696465-1](#) [696475-1](#) [73000005059](#) [73000005349](#) [73000005642](#) [73080255059](#) [73080965046](#) [765-15-0080A](#)
[765-16-0080B](#) [789.700-44](#) [789.700-54](#) [80-1010](#) [80-9](#) [827381-1](#) [829992-1](#) [902-77-02113](#) [PL00U-301-10D10](#) [PM103MOOLOO](#)
[PM16S1620S32-50](#) [PM212MOOLOO](#) [PM309FOOLOO](#) [PM324FOOLCH](#)