

Connector set - HC-STA-B24PT-BWSC-LT-M32-ELCAL - 1416351

Please be informed that the data shown in this PDF Document is generated from our Online Catalog. Please find the complete data in the user's documentation. Our General Terms of Use for Downloads are valid (<http://phoenixcontact.com/download>)



Connector set, number of positions: 24, material: Die-cast aluminum, salt water resistant, connection method: Push-in connection, connection cross section: AWG 26- 14



Key Commercial Data

Packing unit	1 pc
GTIN	 4 055626 071220
GTIN	4055626071220
Weight per Piece (excluding packing)	0.769 kg
Custom tariff number	85366990
Country of origin	China
Note	Made to Order (non-returnable)

Technical data

General

Number of positions	24+PE
Type	B24
Connection method	Push-in connection
Degree of protection for housing	IP66
	IP67
Connection method	Push-in connection
Rated voltage (III/3)	500 V
Rated surge voltage	6 kV
Rated current	16 A
Conductor cross section	0.14 mm ² ... 2.5 mm ² (with ferrule)
Connection cross section AWG	26 ... 14
External cable diameter	15 mm ... 21 mm

Connector set - HC-STA-B24PT-BWSC-LT-M32-ELCAL - 1416351

Technical data

General

Ambient temperature (operation)	-40 °C ... 100 °C
Length of the assembly cutout	113 mm
Width of the assembly cutout	35 mm
Housing material	Die-cast aluminum, salt water resistant
Contact carrier material	PC
Locking latch material	PA
Integrated protective cover	Yes

Standards and Regulations

Flammability rating according to UL 94	V0
--	----

Environmental Product Compliance

China RoHS	Environmentally Friendly Use Period = 50
	For details about hazardous substances go to tab "Downloads", Category "Manufacturer's declaration"

Drawings

Connector set - HC-STA-B24PT-BWSC-LT-M32-ELCAL - 1416351

Schematic diagram

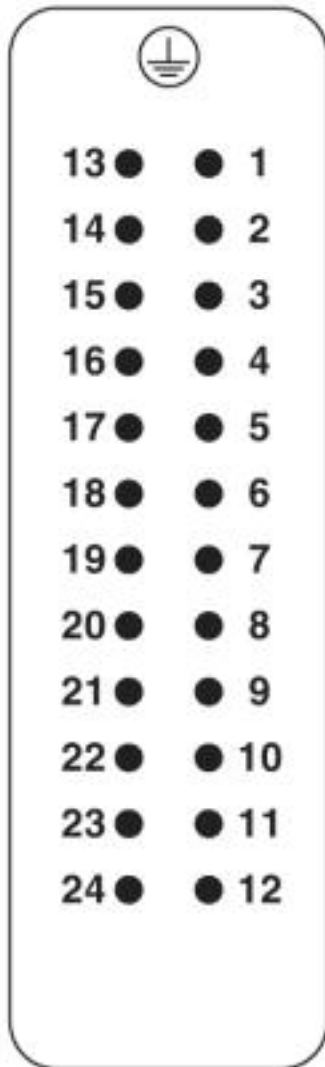

Pin assignment, connection side, pin

Schematic diagram

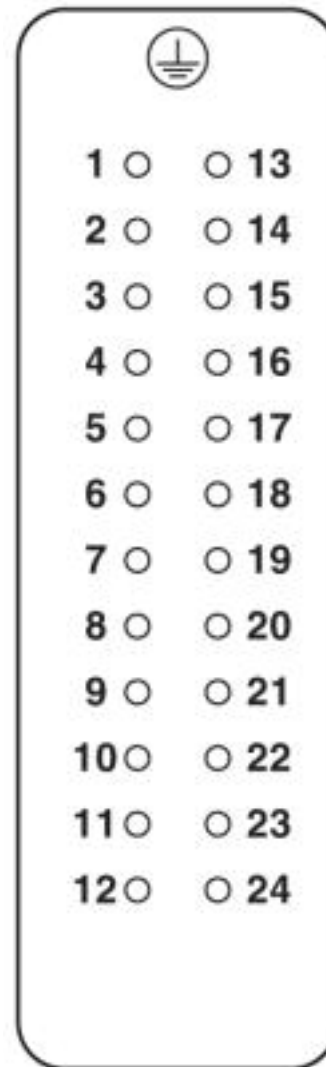

Pin assignment, connection side, socket

Connector set - HC-STA-B24PT-BWSC-LT-M32-ELCAL - 1416351

Diagram

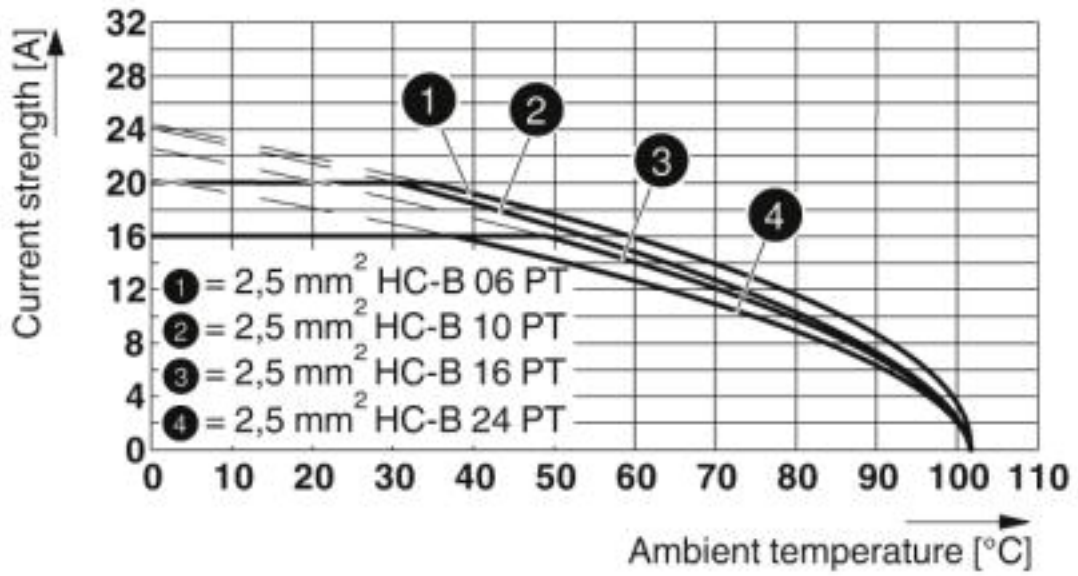

Derating diagram

Connector set - HC-STA-B24PT-BWSC-LT-M32-ELCAL - 1416351

Dimensional drawing

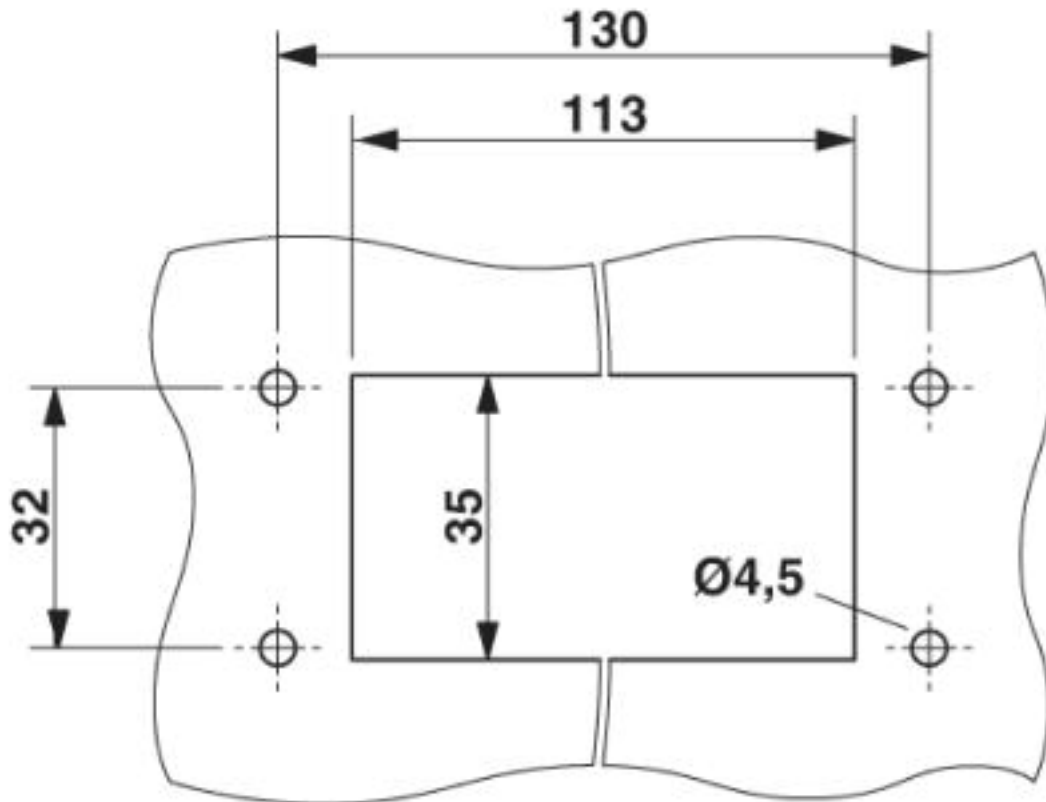

Mounting cutout

Connector set - HC-STA-B24PT-BWSC-LT-M32-ELCAL - 1416351

Dimensional drawing

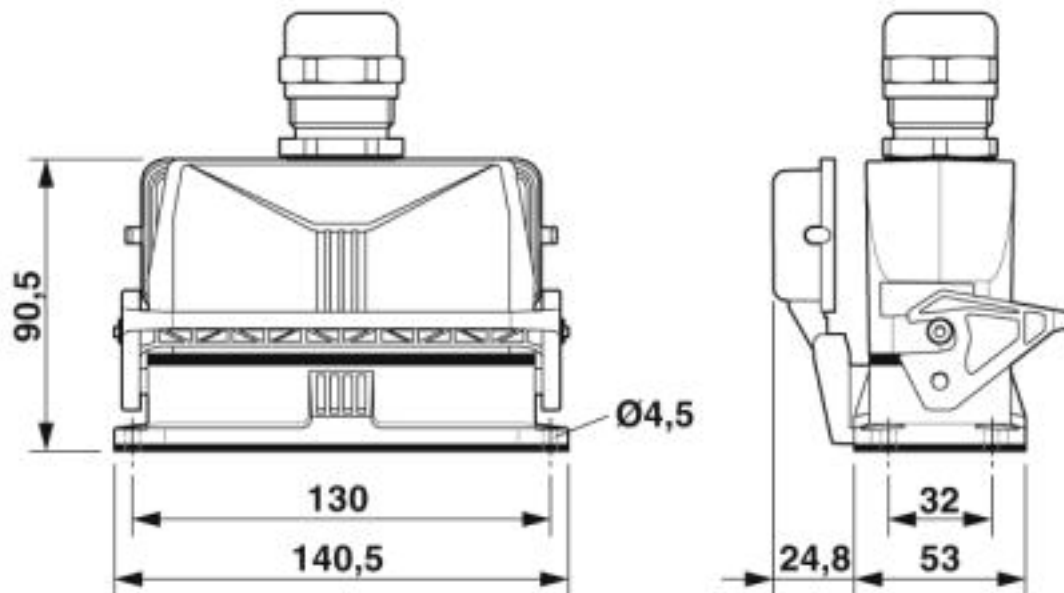

Dimensional drawing

Articles in set

Contact insert - HC-B24-I-PT-F - 1407735



Contact insert, number of positions: 24+PE, size: B24, number of connections per position: 1, Socket, Push-in connection, 500 V, 16 A, 0.14 mm² ... 2.5 mm², application: Power

Contact insert - HC-B24-I-PT-M - 1407736



HEAVYCON pin insert, B24 series, 24 + PE-pos., push-in connection

Housing - HC-STA-B24-BWSC-ELC-AL - 1411330



HEAVYCON B24 panel mounting base, with single locking latch, with plastic protective cover, with flat gasket, salt-water-resistant aluminum, conductive profile gasket.

Connector set - HC-STA-B24PT-BWSC-LT-M32-ELCAL - 1416351

Articles in set

Housing - HC-STA-B24-HLFS-1TTM32-EL-AL - 1412789



Sleeve housing B24, for single locking latch, material: Die-cast aluminum, salt water resistant, cable outlets: 1, straight, height: 60 mm, cable gland: none, support sleeve: no, 1x M32, Standard

Cable gland - G-INS-M32-M68N-NNES-S - 1411166



Cable gland, cable gland material: Nickel-plated brass, external cable diameter 15 mm ... 21 mm, shielding: no, connecting thread: M32 x 1.5, color: silver, with O-ring

Classifications

eCl@ss

eCl@ss 4.0	27260700
eCl@ss 4.1	27260700
eCl@ss 5.0	27260700
eCl@ss 5.1	27260700
eCl@ss 6.0	27260700
eCl@ss 7.0	27440101
eCl@ss 8.0	27440101
eCl@ss 9.0	27440101

ETIM

ETIM 5.0	EC002636
ETIM 6.0	EC002636
ETIM 7.0	EC002636

UNSPSC

UNSPSC 13.2	39121409
-------------	----------

Approvals

Approvals

Approvals

EAC / DNV GL

Connector set - HC-STA-B24PT-BWSC-LT-M32-ELCAL - 1416351

Approvals

Ex Approvals

Approval details

EAC		RU C- DE.AI30.B.01102
-----	---	--------------------------

DNV GL		https://approvalfinder.dnvgl.com/	TAE000037S
--------	---	---	------------

Phoenix Contact 2019 © - all rights reserved
<http://www.phoenixcontact.com>

X-ON Electronics

Largest Supplier of Electrical and Electronic Components

Click to view similar products for [Heavy Duty Power Connectors](#) category:

Click to view products by [Phoenix Contact](#) manufacturer:

Other Similar products are found below :

[1424439](#) [1424438](#) [09330062652](#) [2-8675P1](#) [580129-2](#) [605601-1](#) [6340G1](#) [6341G1](#) [6360G1](#) [6373G1](#) [6374g2](#) [6396G1](#) [647757-1](#) [66394-4](#)
[6643411-1](#) [6646058-2](#) [6646137-1](#) [6646138-1](#) [6646348-1](#) [6646479-1](#) [6646608-1](#) [6646786-1](#) [6646940-1](#) [6651091-1](#) [6651525-1](#) [6651529-1](#)
[6651778-1](#) [6651788-1](#) [696465-1](#) [696475-1](#) [73000005059](#) [73000005349](#) [73000005642](#) [73080255059](#) [73080965046](#) [765-15-0080A](#)
[765-16-0080B](#) [789.700-44](#) [789.700-54](#) [80-1010](#) [80-9](#) [827381-1](#) [829992-1](#) [902-77-02113](#) [PL00U-301-10D10](#) [PM103MOOLOO](#)
[PM16S1620S32-50](#) [PM212MOOLOO](#) [PM309FOOLOO](#) [PM324FOOLCH](#)