

Connector set - HC-STA-B06PT-BWSC-LS-M20-ELCAL - 1416353

Please be informed that the data shown in this PDF Document is generated from our Online Catalog. Please find the complete data in the user's documentation. Our General Terms of Use for Downloads are valid (<http://phoenixcontact.com/download>)



Connector set, number of positions: 6, material: Die-cast aluminum, salt water resistant, connection method: Push-in connection, connection cross section: AWG 26- 14, cable outlet: lateral



Key Commercial Data

Packing unit	1 pc
GTIN	 4 055626 071244
GTIN	4055626071244

Technical data

General

Number of positions	6+PE
Type	B6
Connection method	Push-in connection
Cable outlet	lateral
Degree of protection for housing	IP66 (with locked protective cover) IP67 (when plugged in)
Connection method	Push-in connection
Rated voltage (III/3)	500 V
Rated surge voltage	6 kV
Rated current	16 A
Conductor cross section	0.14 mm ² ... 2.5 mm ² (with ferrule)
Connection cross section AWG	26 ... 14
External cable diameter	6 mm ... 12 mm
Ambient temperature (operation)	-40 °C ... 100 °C
Length of the assembly cutout	52 mm
Width of the assembly cutout	35 mm
Housing material	Die-cast aluminum, salt water resistant

Connector set - HC-STA-B06PT-BWSC-LS-M20-ELCAL - 1416353

Technical data

General

Contact carrier material	PC
Locking latch material	PA
Integrated protective cover	Yes

Standards and Regulations

Flammability rating according to UL 94	V0
--	----

Environmental Product Compliance

REACH SVHC	Lead 7439-92-1
China RoHS	Environmentally friendly use period: unlimited = EFUP-e
	No hazardous substances above threshold values

Drawings

Connector set - HC-STA-B06PT-BWSC-LS-M20-ELCAL - 1416353

Schematic diagram

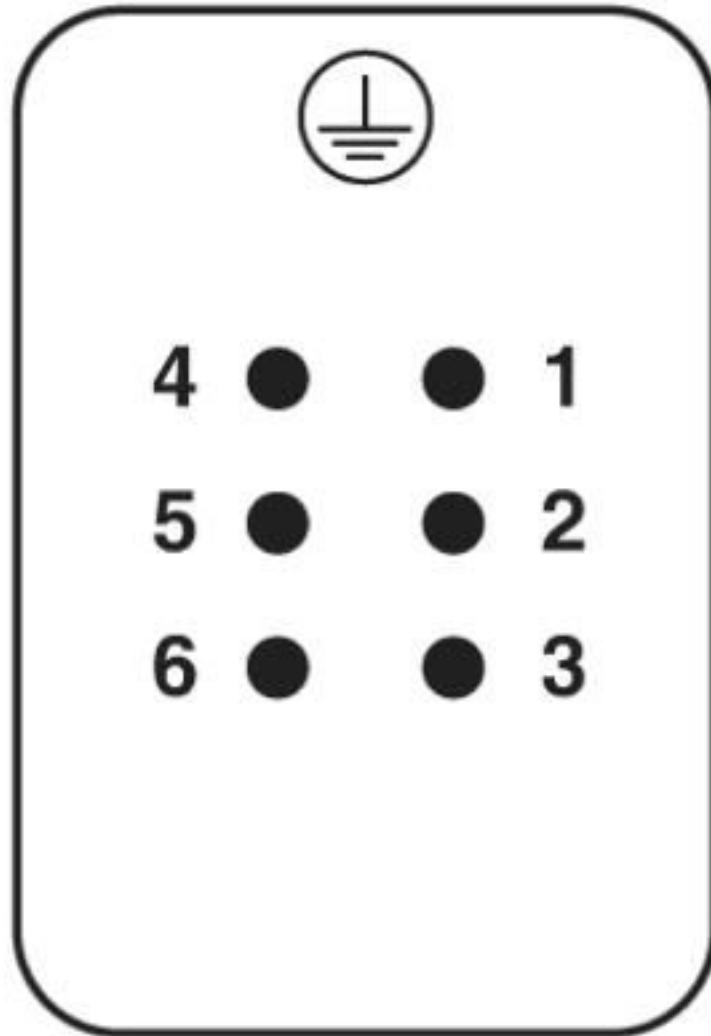

Pin assignment, connection side, pin

Connector set - HC-STA-B06PT-BWSC-LS-M20-ELCAL - 1416353

Schematic diagram

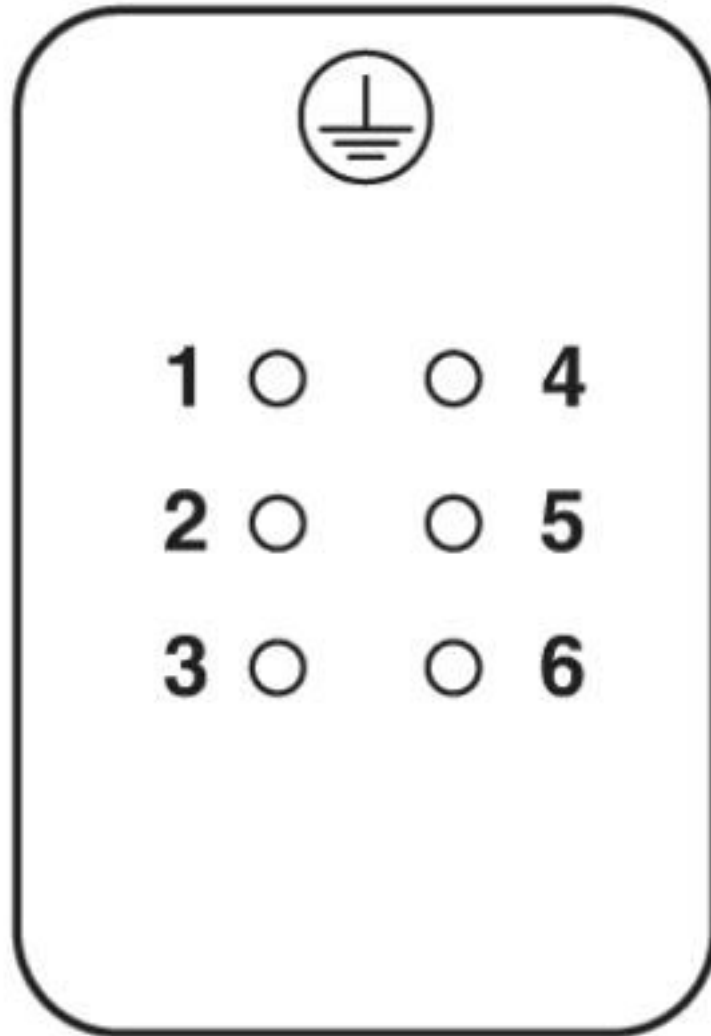

Pin assignment, connection side, socket

Connector set - HC-STA-B06PT-BWSC-LS-M20-ELCAL - 1416353

Diagram

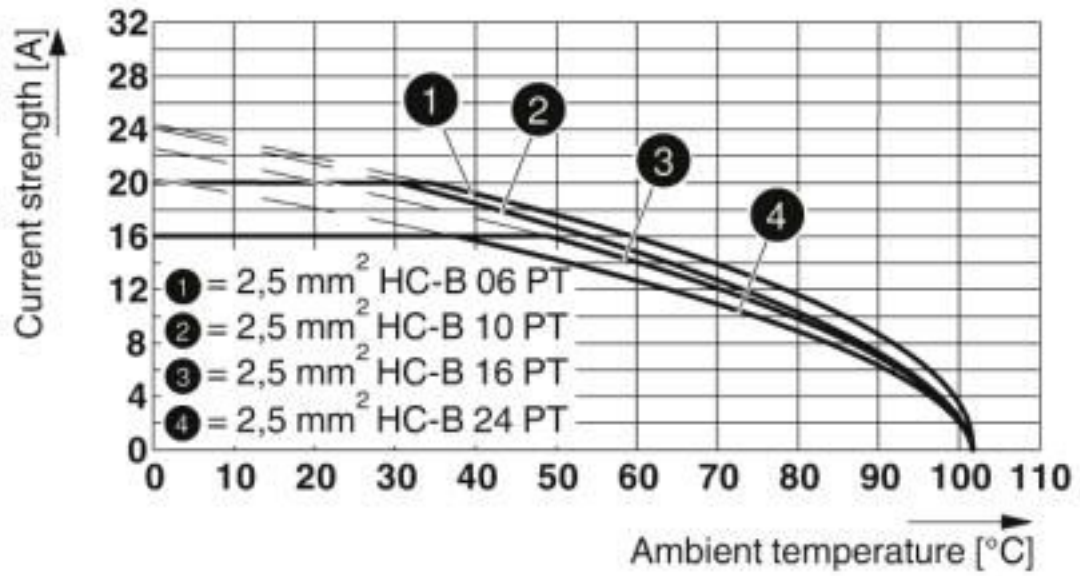

Derating diagram

Connector set - HC-STA-B06PT-BWSC-LS-M20-ELCAL - 1416353

Dimensional drawing

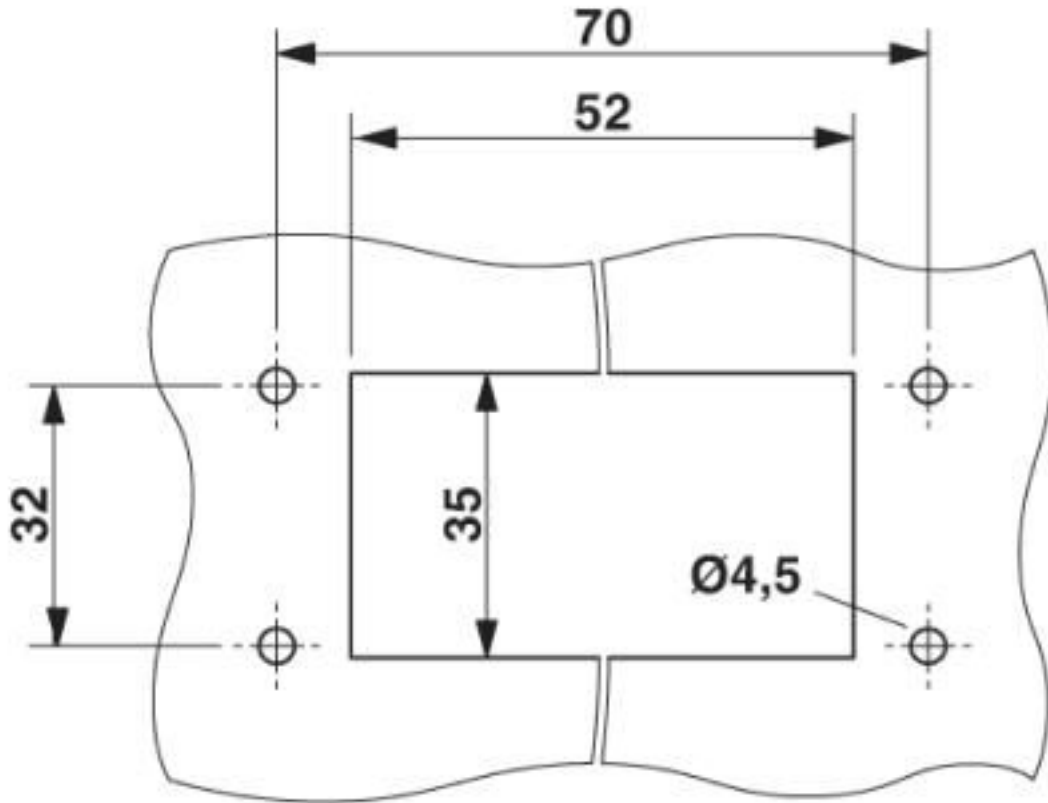

Mounting cutout

Dimensional drawing

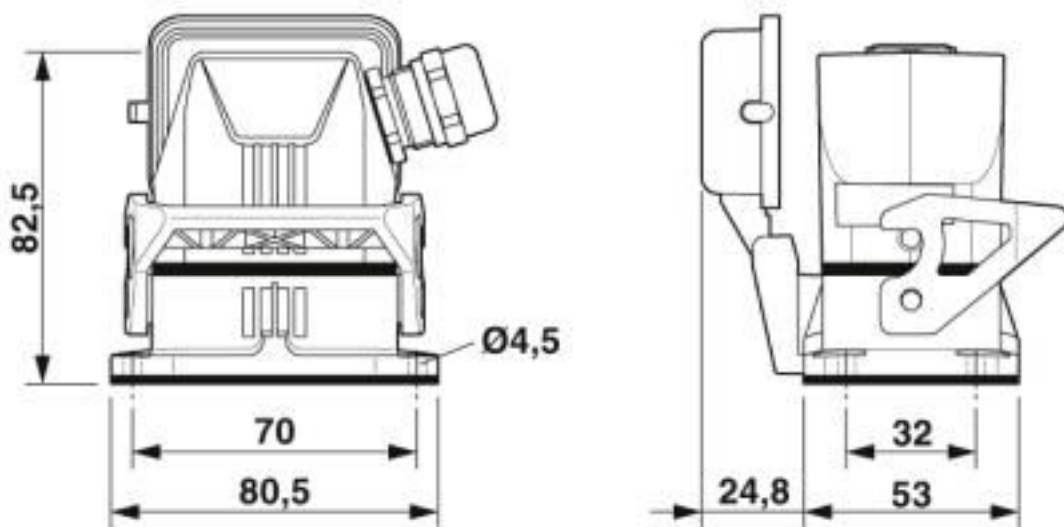

Dimensional drawing

Connector set - HC-STA-B06PT-BWSC-LS-M20-ELCAL - 1416353

Articles in set

Contact insert - HC-B06-I-PT-F - 1407727



HEAVYCON socket insert, B6 series, 6 + PE-pos., push-in connection

Contact insert - HC-B06-I-PT-M - 1407728



HEAVYCON pin insert, B6 series, 6 + PE-pos., push-in connection

Cable gland - G-INS-M20-S68N-NNES-S - 1411163



Cable gland, cable gland material: Nickel-plated brass, external cable diameter 6 mm ... 12 mm, shielding: no, connecting thread: M20 x 1.5, color: silver, with O-ring

Housing - HC-STA-B06-BWSC-ELC-AL - 1411319



HEAVYCON B6 panel mounting base, with single locking latch, with plastic protective cover, with flat gasket, salt-water-resistant aluminum, conductive profile gasket.

Housing - HC-STA-B06-HLFS-1STM20-EL-AL - 1412570



Sleeve housing B6, for single locking latch, material: Die-cast aluminum, salt water resistant, cable outlets: 1, lateral, height: 52 mm, cable gland: none, support sleeve: no, 1x M20, Standard

Classifications

eCl@ss

eCl@ss 10.0.1	27440101
eCl@ss 4.0	27260700

Connector set - HC-STA-B06PT-BWSC-LS-M20-ELCAL - 1416353

Classifications

eCl@ss

eCl@ss 4.1	27260700
eCl@ss 5.0	27260700
eCl@ss 5.1	27260700
eCl@ss 6.0	27260700
eCl@ss 7.0	27440101
eCl@ss 8.0	27440101
eCl@ss 9.0	27440101

ETIM

ETIM 5.0	EC002636
ETIM 6.0	EC002636
ETIM 7.0	EC002636

UNSPSC

UNSPSC 13.2	39121409
UNSPSC 18.0	39121409
UNSPSC 19.0	39121409
UNSPSC 20.0	39121409
UNSPSC 21.0	39121409

Approvals

Approvals

Approvals

EAC / DNV GL / EAC

Ex Approvals

Approval details

EAC		RU C- DE.AI30.B.01102
-----	---	--------------------------

DNV GL		https://approvalfinder.dnvgl.com/	TAE000037S
--------	---	---	------------

Connector set - HC-STA-B06PT-BWSC-LS-M20-ELCAL - 1416353

Approvals

EAC		RU C- DE.BL08.B.00511
-----	---	--------------------------

Accessories

Accessories

Device marking

Plastic label - US-EMLP-HA (20X9) - 0830989



Plastic label, Card, white, unlabeled, can be labeled with: BLUEMARK ID COLOR, BLUEMARK ID, THERMOMARK PRIME, THERMOMARK CARD 2.0, THERMOMARK CARD, mounting type: adhesive, lettering field size: 20 x 9 mm, Number of individual labels: 70

Phoenix Contact 2020 © - all rights reserved
<http://www.phoenixcontact.com>

PHOENIX CONTACT GmbH & Co. KG
Flachsmarktstr. 8
32825 Blomberg
Germany
Tel. +49 5235 300
Fax +49 5235 3 41200
<http://www.phoenixcontact.com>

X-ON Electronics

Largest Supplier of Electrical and Electronic Components

Click to view similar products for [Heavy Duty Power Connectors](#) category:

Click to view products by [Phoenix Contact](#) manufacturer:

Other Similar products are found below :

[647757-1](#) [6643411-1](#) [6646058-2](#) [6646137-1](#) [6646138-1](#) [6646479-1](#) [6646608-1](#) [6646786-1](#) [6646940-1](#) [6651091-1](#) [6651525-1](#) [6651529-1](#)
[6651788-1](#) [696475-1](#) [702-32-01109](#) [703-25-02205](#) [73000005059](#) [73000005642](#) [73080255059](#) [73080965046](#) [765-15-0080A](#) [765-16-0080B](#)
[765-18-0080D](#) [829992-1](#) [902-77-02113](#) [PS00/A0620/6300](#) [PS25/A0420/63](#) [129-1J](#) [1409400](#) [AN0024023](#) [E6374G1](#) [e6389g2](#) [157-43GW8](#)
[MS3117-14AC](#) [1643543-1](#) [1650540-1](#) [1651811-2](#) [1766260-1](#) [1766282-1](#) [1766966-1](#) [1791340000](#) [NLDFT-3-BL-L-S120-M40A](#) [NLDFT-N-](#)
[W-L-C240-M40B](#) [NLS-2-R-C240-M40B](#) [NLS-N-W-C240-M40B](#) [NPS-3-BL-T6](#) [1986615-1](#) [2-1589900-8](#) [2199314-1](#) [KA8102](#)