

# Connector set - HC-STA-B10PT-BWSC-LS-M25-ELCAL - 1416354

Please be informed that the data shown in this PDF Document is generated from our Online Catalog. Please find the complete data in the user's documentation. Our General Terms of Use for Downloads are valid (<http://phoenixcontact.com/download>)



Connector set, number of positions: 10, material: Die-cast aluminum, salt water resistant, connection method: Push-in connection, connection cross section: AWG 26- 14



## Key Commercial Data

Packing unit	1 pc
GTIN	 4 055626 071251
GTIN	4055626071251

## Technical data

### General

Number of positions	10+PE
Type	B10
Connection method	Push-in connection
Degree of protection for housing	IP66
	IP67
Connection method	Push-in connection
Rated voltage (III/3)	500 V
Rated surge voltage	6 kV
Rated current	16 A
Conductor cross section	0.14 mm <sup>2</sup> ... 2.5 mm <sup>2</sup> (with ferrule)
Connection cross section AWG	26 ... 14
External cable diameter	11 mm ... 17 mm
Ambient temperature (operation)	-40 °C ... 100 °C
Length of the assembly cutout	65 mm
Width of the assembly cutout	35 mm
Housing material	Die-cast aluminum, salt water resistant
Contact carrier material	PC

# Connector set - HC-STA-B10PT-BWSC-LS-M25-ELCAL - 1416354

## Technical data

### General

Locking latch material	PA
Integrated protective cover	Yes

### Standards and Regulations

Flammability rating according to UL 94	V0
--	----

### Environmental Product Compliance

REACH SVHC	Lead 7439-92-1
China RoHS	Environmentally Friendly Use Period = 50 years
	For details about hazardous substances go to tab "Downloads", Category "Manufacturer's declaration"

## Drawings

# Connector set - HC-STA-B10PT-BWSC-LS-M25-ELCAL - 1416354

Schematic diagram

Schematic diagram

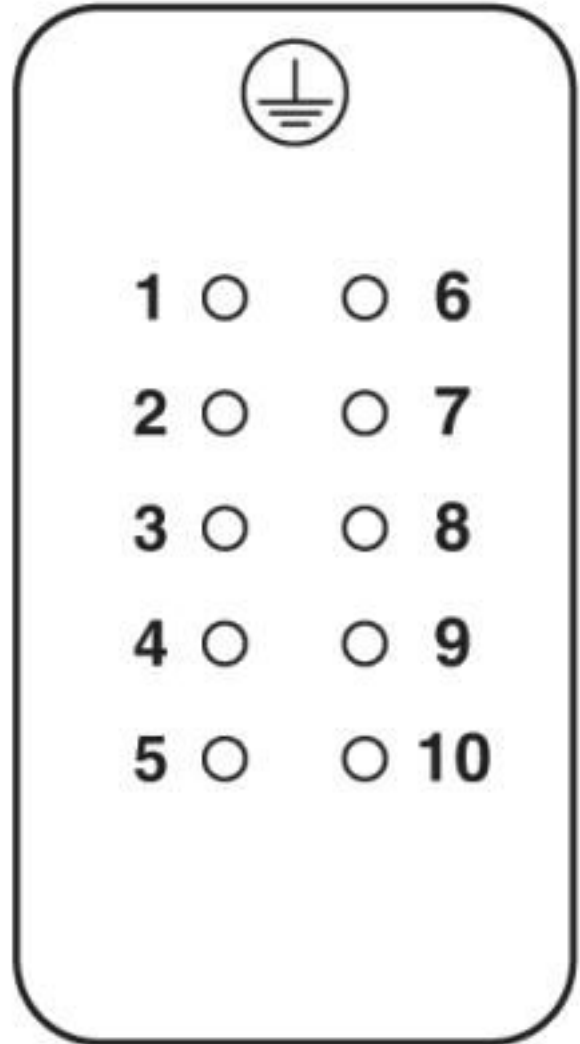
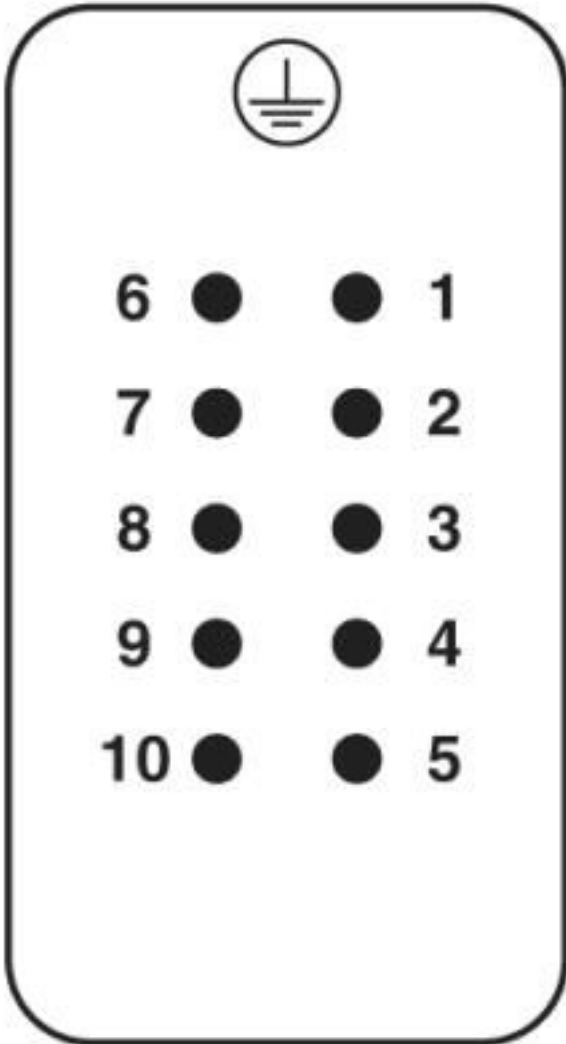

Pin assignment, connection side, pin

Pin assignment, connection side, socket

# Connector set - HC-STA-B10PT-BWSC-LS-M25-ELCAL - 1416354

Diagram

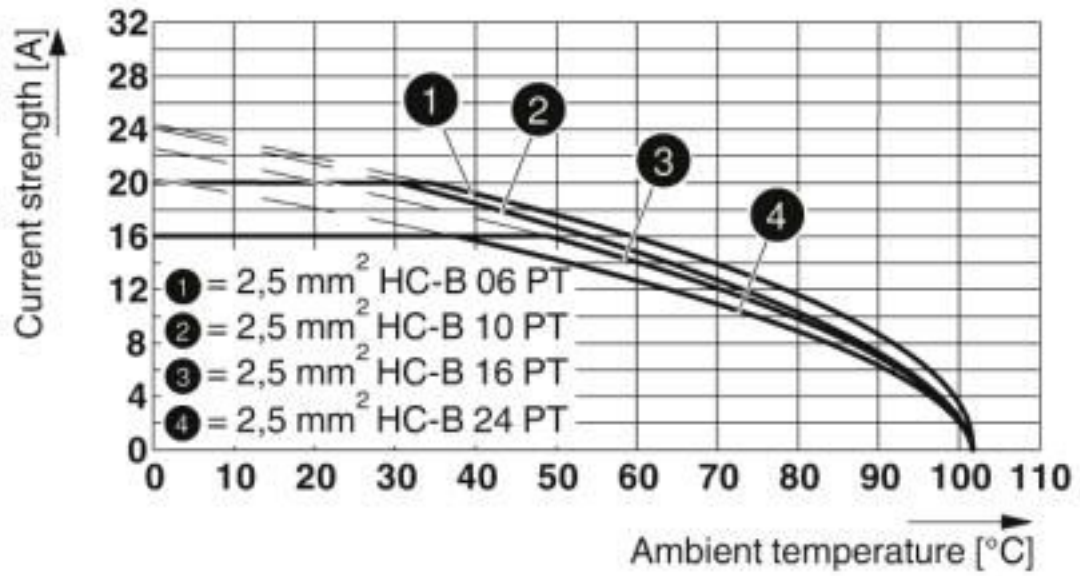

Derating diagram

# Connector set - HC-STA-B10PT-BWSC-LS-M25-ELCAL - 1416354

Dimensional drawing

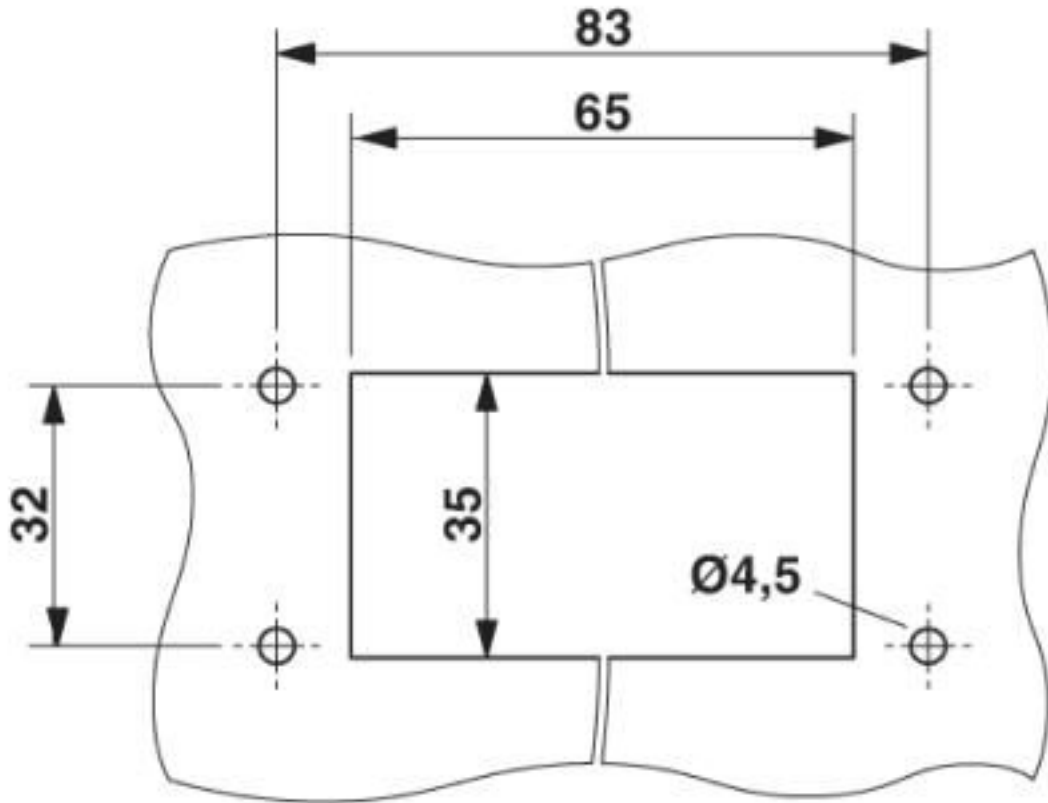

Mounting cutout

Dimensional drawing

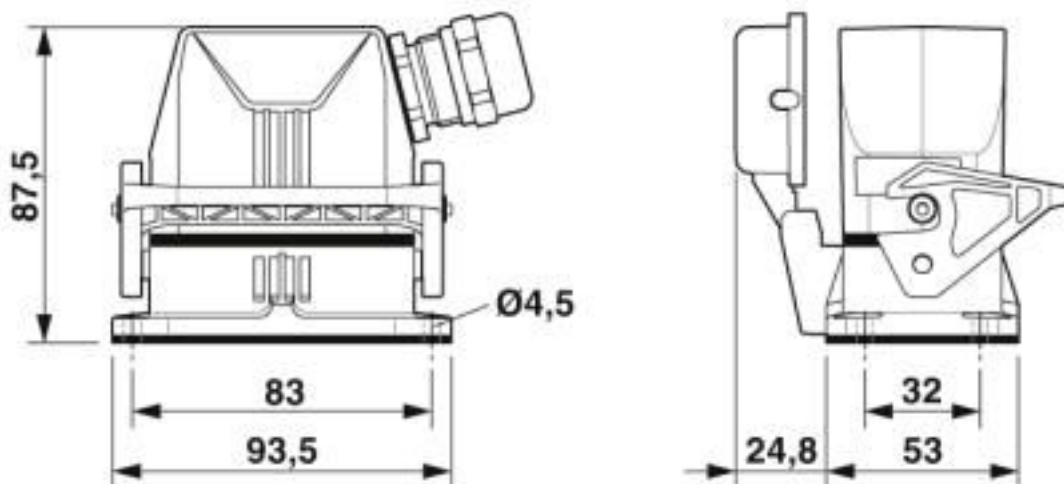

Dimensional drawing

# Connector set - HC-STA-B10PT-BWSC-LS-M25-ELCAL - 1416354

## Articles in set

Contact insert - HC-B10-I-PT-F - 1407729



HEAVYCON socket insert, B10 series, 10 + PE-pos., push-in connection

Contact insert - HC-B10-I-PT-M - 1407730



HEAVYCON pin insert, B10 series, 10 + PE-pos., push-in connection

Housing - HC-STA-B10-BWSC-ELC-AL - 1411321



HEAVYCON panel mounting base, B10, with single locking latch, with plastic protective cover, with flat gasket, salt-water-resistant aluminum, conductive profile gasket.

Housing - HC-STA-B10-HLFS-1STM25-EL-AL - 1412625



Sleeve housing B10, for single locking latch, material: Die-cast aluminum, salt water resistant, cable outlets: 1, lateral, height: 57 mm, cable gland: none, support sleeve: no, 1x M25, Standard

Cable gland - G-INS-M25-M68N-NNES-S - 1411165



Cable gland, cable gland material: Nickel-plated brass, external cable diameter 11 mm ... 17 mm, shielding: no, connecting thread: M25 x 1.5, color: silver, with O-ring

## Classifications

eCl@ss

eCl@ss 10.0.1	27440101
eCl@ss 4.0	27260700

# Connector set - HC-STA-B10PT-BWSC-LS-M25-ELCAL - 1416354

## Classifications

### eCl@ss

eCl@ss 4.1	27260700
eCl@ss 5.0	27260700
eCl@ss 5.1	27260700
eCl@ss 6.0	27260700
eCl@ss 7.0	27440101
eCl@ss 8.0	27440101
eCl@ss 9.0	27440101

### ETIM

ETIM 5.0	EC002636
ETIM 6.0	EC002636
ETIM 7.0	EC002636

### UNSPSC

UNSPSC 13.2	39121409
UNSPSC 18.0	39121409
UNSPSC 19.0	39121409
UNSPSC 20.0	39121409
UNSPSC 21.0	39121409

## Approvals

### Approvals

#### Approvals

EAC / DNV GL / EAC

#### Ex Approvals

### Approval details

EAC		RU C- DE.AI30.B.01102
-----	---	--------------------------

DNV GL		<a href="https://approvalfinder.dnvgl.com/">https://approvalfinder.dnvgl.com/</a>	TAE000037S
--------	---	---	------------

## Connector set - HC-STA-B10PT-BWSC-LS-M25-ELCAL - 1416354

### Approvals

EAC



RU C-  
DE.BL08.B.00511

Phoenix Contact 2020 © - all rights reserved  
<http://www.phoenixcontact.com>

PHOENIX CONTACT GmbH & Co. KG  
Flachsmarktstr. 8  
32825 Blomberg  
Germany  
Tel. +49 5235 300  
Fax +49 5235 3 41200  
<http://www.phoenixcontact.com>



## X-ON Electronics

Largest Supplier of Electrical and Electronic Components

*Click to view similar products for [Heavy Duty Power Connectors](#) category:*

*Click to view products by [Phoenix Contact](#) manufacturer:*

Other Similar products are found below :

[647757-1](#) [6643411-1](#) [6646058-2](#) [6646137-1](#) [6646138-1](#) [6646479-1](#) [6646608-1](#) [6646786-1](#) [6646940-1](#) [6651091-1](#) [6651525-1](#) [6651529-1](#)  
[6651788-1](#) [696475-1](#) [702-32-01109](#) [703-25-02205](#) [73000005059](#) [73000005642](#) [73080965046](#) [765-15-0080A](#) [765-16-0080B](#) [765-18-0080D](#)  
[829992-1](#) [902-77-02113](#) [PS00/A0620/6300](#) [129-1J](#) [1409400](#) [AN0024023](#) [E6374G1](#) [e6389g2](#) [157-43GW8](#) [MS3117-14AC](#) [1643543-1](#)  
[1650540-1](#) [1651811-2](#) [1766260-1](#) [1766282-1](#) [1766966-1](#) [1791340000](#) [NLDFT-3-BL-L-S120-M40A](#) [NLDFT-N-W-L-C240-M40B](#) [NLS-2-R-](#)  
[C240-M40B](#) [NLS-N-W-C240-M40B](#) [NPS-3-BL-T6](#) [1986615-1](#) [2-1589900-8](#) [2199314-1](#) [KA8102](#) [9300480317](#) [SBS50BRN#6](#)