

Protective covers - HC-HPR-B16-BCLWH-E-BK - 1418445

Please be informed that the data shown in this PDF Document is generated from our Online Catalog. Please find the complete data in the user's documentation. Our General Terms of Use for Downloads are valid (<http://phoenixcontact.com/download>)



Protective cover B16, with screw locking, material: Aluminum die-cast, protective cover material: Al, height: 32 mm, for increased environmental and EMC requirements

Your advantages

- Vibration and shock: IEC 61373/EN 50155, category 1, class 1B



Key Commercial Data

Packing unit	1 pc
GTIN	
GTIN	4055626140247

Technical data

Dimensions

Height	32 mm
Width	58 mm
Length	166 mm

Ambient conditions

Degree of protection of housing (IP)	IP66
	IP68
	IP69 (ISO 20653:2013-02)
Ambient temperature (operation)	-40 °C ... 125 °C

General

Note	Protective cover for supporting base elements
Size	B16
Housing type	Protective cover
Color	black
Locking type	with screw locking

Protective covers - HC-HPR-B16-BCLWH-E-BK - 1418445

Technical data

General

Housing material	Aluminum die-cast
Housing surface material	Powder-coated, black
Material of locking screw	Stainless steel
Material, protective cover	Al

Environmental Product Compliance

China RoHS	Environmentally friendly use period: unlimited = EFUP-e
	No hazardous substances above threshold values

Drawings

Dimensional drawing

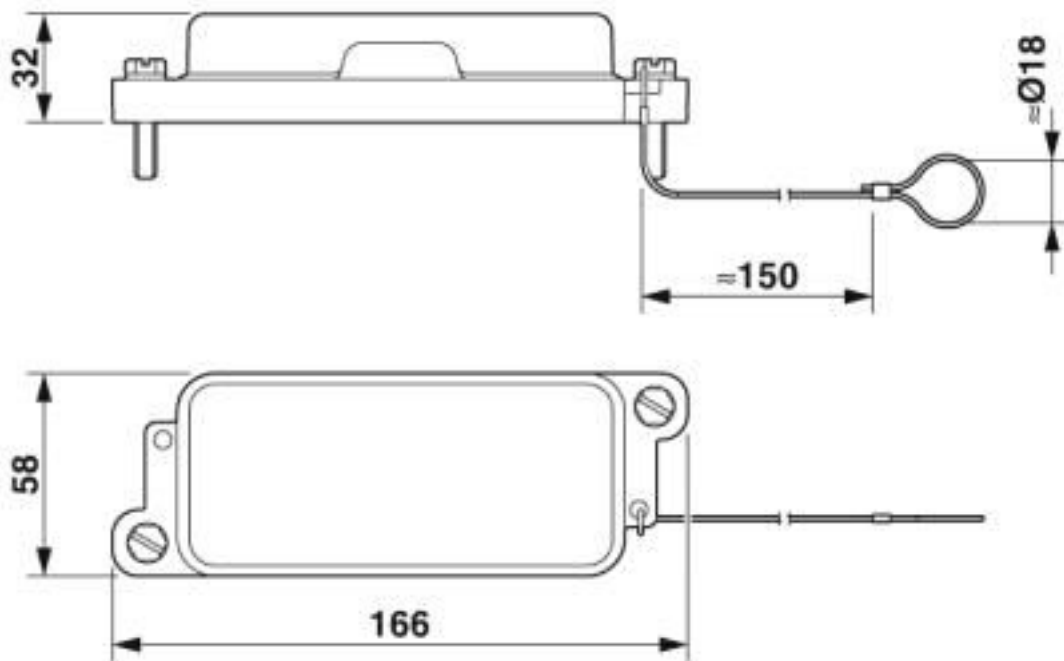

Dimensional drawing

Classifications

eCl@ss

eCl@ss 10.0.1	27440208
eCl@ss 4.0	27141200
eCl@ss 4.1	27141200
eCl@ss 5.0	27149100
eCl@ss 5.1	27149100
eCl@ss 6.0	27261200
eCl@ss 7.0	27440208

Protective covers - HC-HPR-B16-BCLWH-E-BK - 1418445

Classifications

eCl@ss

eCl@ss 8.0	27440208
eCl@ss 9.0	27440208

ETIM

ETIM 2.0	EC000241
ETIM 3.0	EC002040
ETIM 4.0	EC002314
ETIM 5.0	EC002314
ETIM 6.0	EC002314
ETIM 7.0	EC002314

UNSPSC

UNSPSC 6.01	30212113
UNSPSC 7.0901	39121712
UNSPSC 11	39121712
UNSPSC 12.01	39121712
UNSPSC 13.2	39121421
UNSPSC 18.0	39121421
UNSPSC 19.0	39121421
UNSPSC 20.0	39121421
UNSPSC 21.0	39121421

Approvals

Approvals

Approvals

EAC

Ex Approvals

Approval details

EAC		RU C- DE.AI30.B.01102
-----	--	--------------------------

Phoenix Contact 2020 © - all rights reserved
<http://www.phoenixcontact.com>

PHOENIX CONTACT GmbH & Co. KG
Flachsmarktstr. 8
32825 Blomberg
Germany
Tel. +49 5235 300
Fax +49 5235 3 41200
<http://www.phoenixcontact.com>

X-ON Electronics

Largest Supplier of Electrical and Electronic Components

Click to view similar products for [Heavy Duty Power Connectors](#) category:

Click to view products by [Phoenix Contact](#) manufacturer:

Other Similar products are found below :

[647757-1](#) [6643411-1](#) [6646058-2](#) [6646137-1](#) [6646138-1](#) [6646479-1](#) [6646608-1](#) [6646786-1](#) [6646940-1](#) [6651091-1](#) [6651525-1](#) [6651529-1](#)
[6651788-1](#) [696475-1](#) [702-32-01109](#) [703-25-02205](#) [73000005059](#) [73000005642](#) [73080255059](#) [73080965046](#) [765-15-0080A](#) [765-16-0080B](#)
[765-18-0080D](#) [829992-1](#) [902-77-02113](#) [PS00/A0620/6300](#) [PS25/A0420/63](#) [129-1J](#) [1409400](#) [AN0024023](#) [E6374G1](#) [e6389g2](#) [157-43GW8](#)
[MS3117-14AC](#) [1643543-1](#) [1650540-1](#) [1651811-2](#) [1766260-1](#) [1766282-1](#) [1766966-1](#) [1791340000](#) [NLDFT-3-BL-L-S120-M40A](#) [NLDFT-N-](#)
[W-L-C240-M40B](#) [NLS-2-R-C240-M40B](#) [NLS-N-W-C240-M40B](#) [NPS-3-BL-T6](#) [1986615-1](#) [2-1589900-8](#) [2199314-1](#) [KA8102](#)