

## Contact insert - HC-Q12-I-CT-M - 1418626

Please be informed that the data shown in this PDF Document is generated from our Online Catalog. Please find the complete data in the user's documentation. Our General Terms of Use for Downloads are valid (<http://phoenixcontact.com/download>)



Contact insert, number of positions: 12+PE, size: D7, number of connections per position: 1, Pin, Crimp connection, 400 V, 12 A, 0.14 mm<sup>2</sup> ... 2.5 mm<sup>2</sup>

### Your advantages

- ✔ Can be keyed in seconds thanks to plastic profiles
- ✔ 16 coding options without loss of contact space.
- ✔ For all D7 housing designs
- ✔ Cost-effective and saves space thanks to high number of contacts within a small surface area
- ✔ Contact insert including IP65 sealing screw



### Key Commercial Data

Packing unit	1 pc
GTIN	 4 055626 249391
GTIN	4055626249391

### Technical data

#### General

Note	For HC-D7 housing, crimp contacts CK1,6-ED (crimp contacts not included in scope of supply) Connectors may be operated only when there is no load/voltage.
Connection method	Crimp connection PE connection
Number of connections per position	1
Degree of pollution	3
Overvoltage category	III
Number of positions	12+PE
Insertion/withdrawal cycles	≥ 500
Size	D7
Contact numbering	1 - 12

# Contact insert - HC-Q12-I-CT-M - 1418626

## Technical data

### General

Conductor cross section	0.14 mm <sup>2</sup> ... 2.5 mm <sup>2</sup>
Connection cross section AWG	26 ... 14
Stripping length of the individual wire	8 mm
	6 mm (2.5 mm <sup>2</sup> )
Assembly instructions	To ensure correct use, installation in housing with IP54 protection or better is required
Connection	Contact insert including IP67 sealing screw.

### Ambient conditions

Ambient temperature (operation)	-40 °C ... 125 °C (including heating up of contacts)
---------------------------------	--

### Material data

Seal material	NBR, conductive
Contact material	Copper alloy
Contact surface material	Ag (alternatively Au)
Contact carrier material	PC

### Electrical characteristics

Rated voltage (III/3)	400 V
Rated surge voltage	6 kV
Rated current	12 A

### Standards and Regulations

Flammability rating according to UL 94	V0
--	----

### Environmental Product Compliance

REACH SVHC	Lead 7439-92-1
China RoHS	Environmentally Friendly Use Period = 50 years
	For details about hazardous substances go to tab "Downloads", Category "Manufacturer's declaration"

## Drawings

# Contact insert - HC-Q12-I-CT-M - 1418626

Diagram

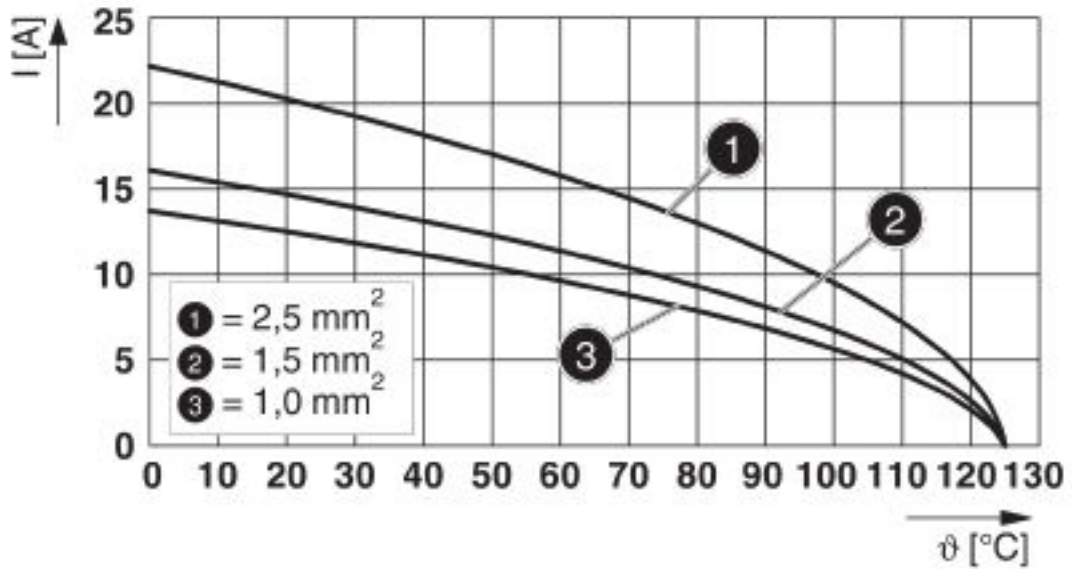

Derating diagram turned contacts

Diagram

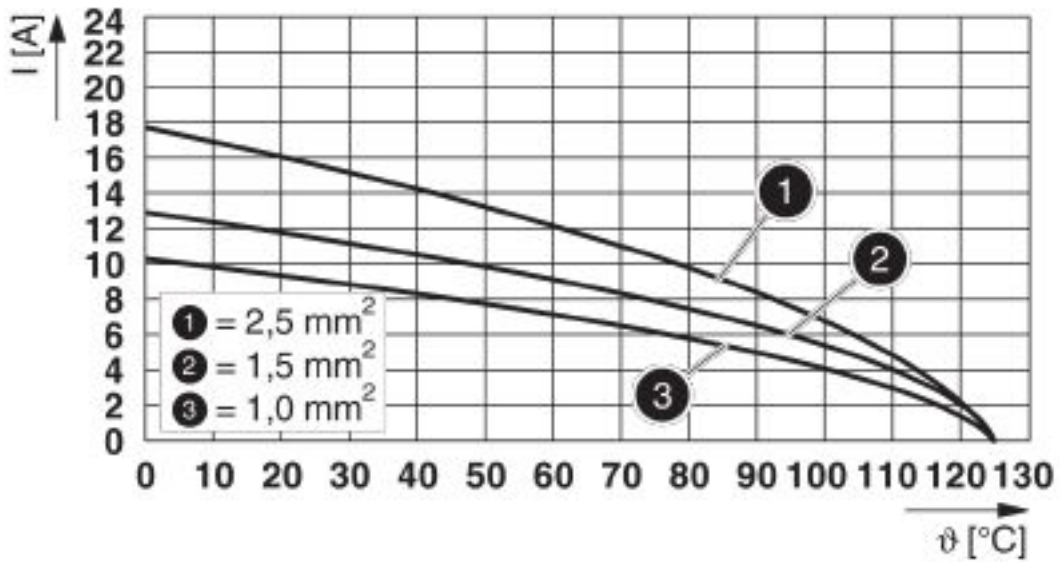

Derating diagram rolled contacts

## Contact insert - HC-Q12-I-CT-M - 1418626

Dimensional drawing

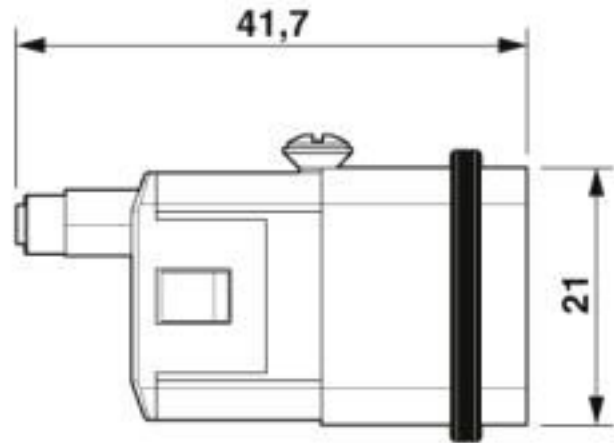
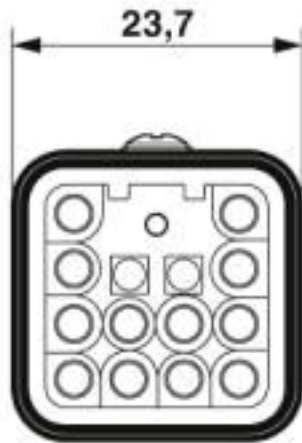

Dimensional drawing: HC-Q 12-I-CT-M

# Contact insert - HC-Q12-I-CT-M - 1418626

Schematic diagram

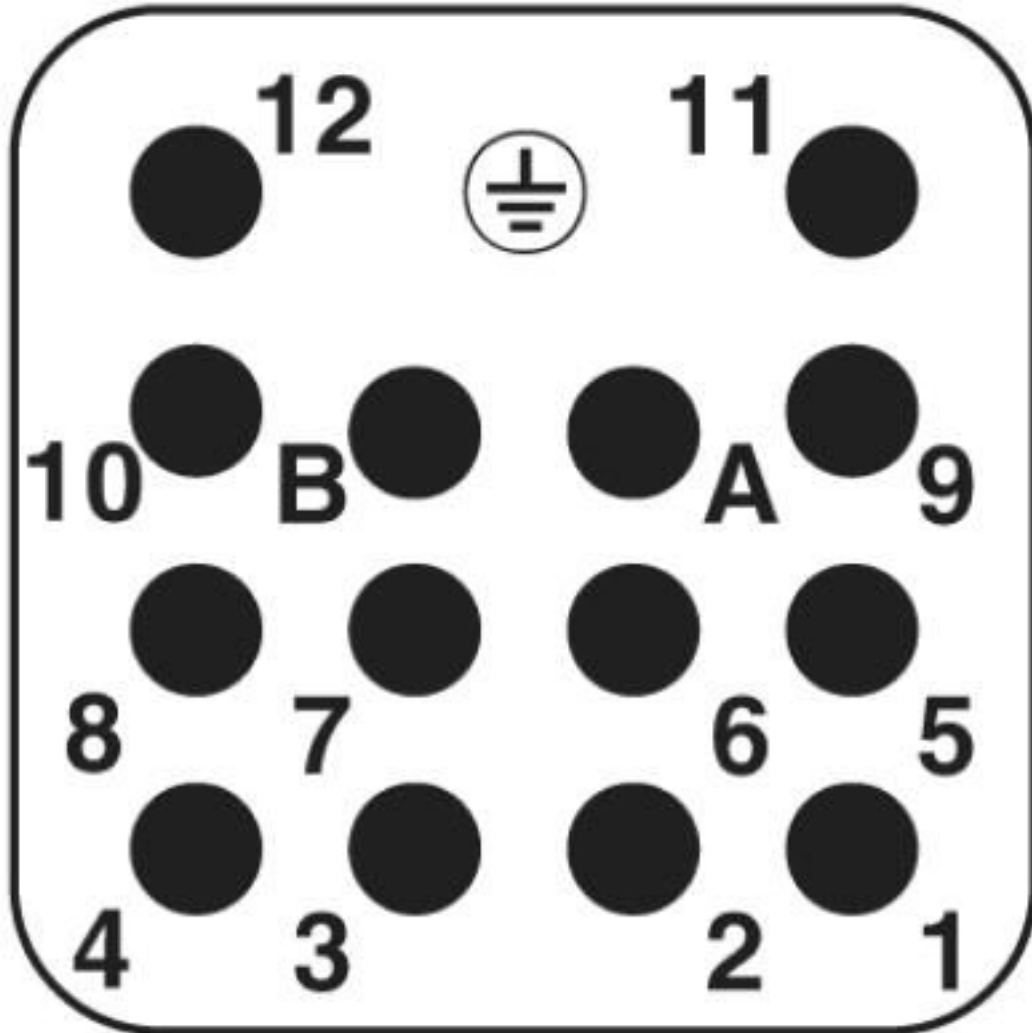

Pin assignment connection side. Position A and B for coding profiles

## Contact insert - HC-Q12-I-CT-M - 1418626

Schematic diagram

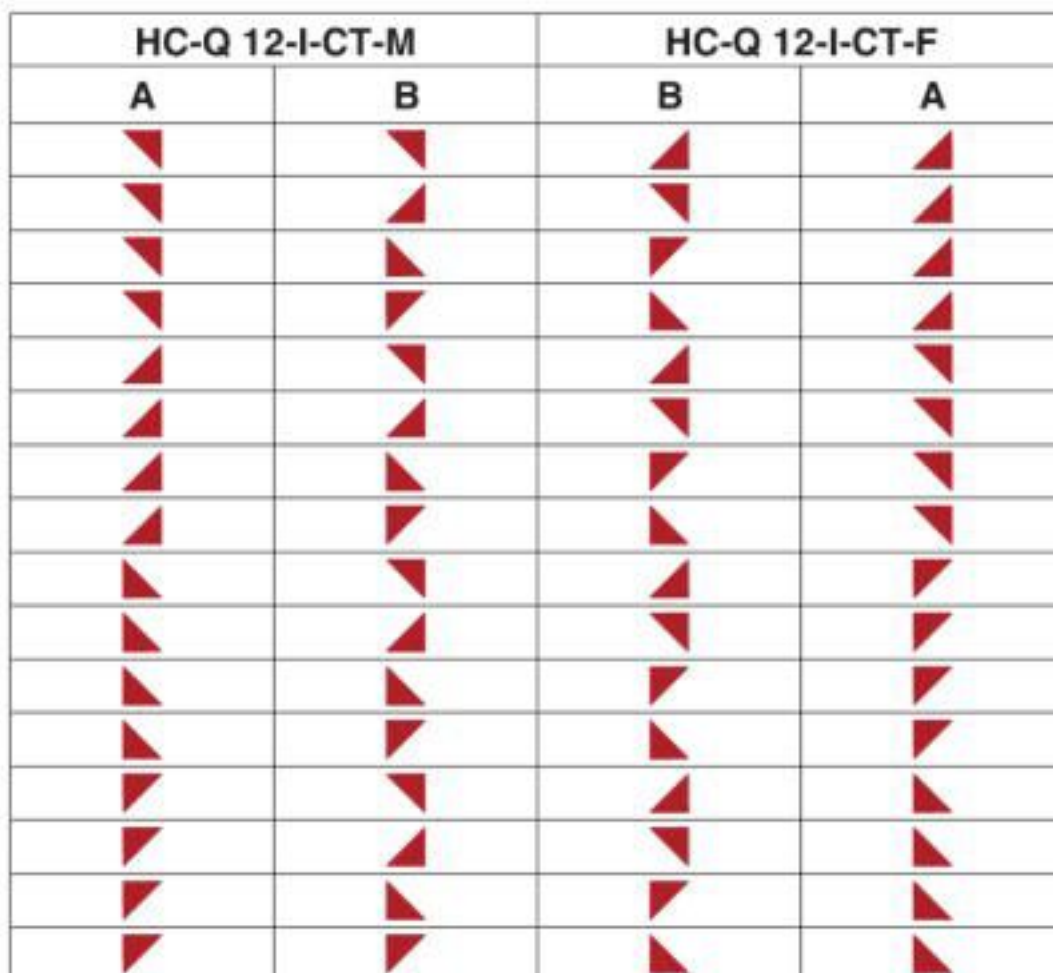

Coding scheme

### Classifications

eCl@ss

eCl@ss 10.0.1	27440205
eCl@ss 5.1	27261200
eCl@ss 6.0	27261200
eCl@ss 7.0	27440205
eCl@ss 8.0	27440205
eCl@ss 9.0	27440205

ETIM

ETIM 5.0	EC000438
ETIM 6.0	EC000438
ETIM 7.0	EC000438

# Contact insert - HC-Q12-I-CT-M - 1418626

## Classifications

### UNSPSC

UNSPSC 13.2	39121522
UNSPSC 18.0	39121522
UNSPSC 19.0	39121522
UNSPSC 20.0	39121522
UNSPSC 21.0	39121522

## Approvals

### Approvals

#### Approvals

CSA / UL Recognized / EAC / DNV GL / EAC

#### Ex Approvals

### Approval details

CSA		<a href="http://www.csagroup.org/services-industries/product-listing/">http://www.csagroup.org/services-industries/product-listing/</a>	13631
Nominal voltage UN		600 V	
Nominal current IN		12 A	
mm <sup>2</sup> /AWG/kcmil		14	

UL Recognized		<a href="http://database.ul.com/cgi-bin/XYV/template/LISEXT/1FRAME/index.htm">http://database.ul.com/cgi-bin/XYV/template/LISEXT/1FRAME/index.htm</a>	E118976
Nominal voltage UN		600 V	
Nominal current IN		15 A	
mm <sup>2</sup> /AWG/kcmil		14	

EAC			RU C- DE.AI30.B.01102
-----	--	--	--------------------------

DNV GL		<a href="https://approvalfinder.dnvgl.com/">https://approvalfinder.dnvgl.com/</a>	TAE000037S
--------	--	---	------------

## Contact insert - HC-Q12-I-CT-M - 1418626

### Approvals

EAC



RU C-  
DE.BL08.B.00511

### Accessories

#### Accessories

#### Assembly tool

Contact removal tool - VC-EW 1,6 - 1884869



Contact removal tool, for turned and rolled CK- 1.6-... contacts

#### Coding element

Coding element - HC-Q 12-COD - 1409435



Coding profile for Q12 series

#### Crimp contact

Crimp contact - CK1,6-ED-0,37ST AG - 1663336



Turned 1.6 crimp contact, individual male contact, core diameter 0.14 to 0.37 mm<sup>2</sup>, silver-plated

Crimp contact - CK1,6-ED-0,50ST AG - 1663349



Turned 1.6 crimp contact, individual male contact, core diameter 0.5 mm<sup>2</sup>, silver-plated



## Contact insert - HC-Q12-I-CT-M - 1418626

### Accessories

Crimp contact - CK1,6-ED-0,75ST AG - 1663352



Turned 1.6 crimp contact, individual male contact, core diameter 0.75 mm<sup>2</sup>, silver-plated

---

Crimp contact - CK1,6-ED-1,00ST AG - 1663365



Turned 1.6 crimp contact, individual male contact, core diameter 0.75 to 1.00 mm<sup>2</sup>, silver-plated

---

Crimp contact - CK1,6-ED-1,50ST AG - 1663378



Turned 1.6 crimp contact, individual male contact, core diameter 1.5 mm<sup>2</sup>, silver-plated

---

Crimp contact - CK1,6-ED-2,50ST AG - 1663381



Turned 1.6 crimp contact, individual male contact, core diameter 2.5 mm<sup>2</sup>, silver-plated

---

Crimp contact - CK1,6-ED-0,37ST AU - 1674901



Turned 1.6 crimp contact, individual male contact, core diameter 0.14 to 0.37 mm<sup>2</sup>, gold-plated

---

## Contact insert - HC-Q12-I-CT-M - 1418626

### Accessories

Crimp contact - CK1,6-ED-0,50ST AU - 1672453



Turned 1.6 crimp contact, individual male contact, core diameter 0.5 mm<sup>2</sup>, gold-plated

---

Crimp contact - CK1,6-ED-0,75ST AU - 1674914



Turned 1.6 crimp contact, individual male contact, core diameter 0.75 mm<sup>2</sup>, gold-plated

---

Crimp contact - CK1,6-ED-1,00ST AU - 1674888



Turned 1.6 crimp contact, individual male contact, core diameter 0.75 to 1.00 mm<sup>2</sup>, gold-plated

---

Crimp contact - CK1,6-ED-1,50ST AU - 1674875



Turned 1.6 crimp contact, individual male contact, core diameter 1.5 mm<sup>2</sup>, gold-plated

---

Crimp contact - CK1,6-ED-2,50ST AU - 1674927



Turned 1.6 crimp contact, individual male contact, core diameter 2.5 mm<sup>2</sup>, gold-plated

---

## Contact insert - HC-Q12-I-CT-M - 1418626

### Accessories

Crimp contact - CK1,6-ER-1,00ST OIC AG - 1004360



Crimp contact, contact diameter: 1.6 mm, rolled, Pin, contact material: Cu alloy, nickel-plated, contact surface: silver-plated, connection cross section: 0.34 mm<sup>2</sup> ... 1 mm<sup>2</sup> AWG 22 ... 17

Crimp contact - CK1,6-ER-2,50ST OIC AG - 1004365



Crimp contact, contact diameter: 1.6 mm, rolled, Pin, contact material: Cu alloy, nickel-plated, contact surface: silver-plated, connection cross section: 1.5 mm<sup>2</sup> ... 2.5 mm<sup>2</sup> AWG 16 ... 14

Crimp contact - CK1,6-BR-1,00ST OIC AG - 1004380



Crimp contact, contact diameter: 1.6 mm, rolled, Pin, contact material: Cu alloy, nickel-plated, contact surface: silver-plated, connection cross section: 0.34 mm<sup>2</sup> ... 1 mm<sup>2</sup> AWG 22 ... 17

Crimp contact - CK1,6-BR-2,50ST OIC AG - 1004382



Crimp contact, contact diameter: 1.6 mm, rolled, Pin, contact material: Cu alloy, nickel-plated, contact surface: silver-plated, connection cross section: 1.5 mm<sup>2</sup> ... 2.5 mm<sup>2</sup> AWG 16 ... 14

### Crimping tool

Crimping pliers - CRIMPFOX-TC 4 - 1212113



Crimping pliers, for CK 1,6-ED..., CK 2,5-ED..., CK 4,0-ED... turned contacts, 4 marked die stations, unlockable pressure lock, lateral entry, incl. positioning tool

### Fiber optics contact

## Contact insert - HC-Q12-I-CT-M - 1418626

### Accessories

Male contact - CK1,6-ED-ST-POF - 1884995



POF fiber optic pin contact, turned, for contact carriers (HC-DD...I-CT.../ HC-M-12-CT-.../ HC-M-17-CT-...) of CK1,6-ED... contacts

---

### Mounting material

Sealing screw - HC-D 7-DS-IP65 - 1686229



Sealing screw, size: Countersunk head, IP67, replacement part for D7 size HEAVYCON housing

---

### Seal

Profile gasket - HC-D07-SP-RBK - 1419622



Profile gasket, type: D7, for pin inserts

---

### Additional products

Contact insert - HC-Q12-I-CT-F - 1418625



Contact insert, number of positions: 12+PE, size: D7, number of connections per position: 1, Socket, Crimp connection, 400 V, 12 A, 0.14 mm<sup>2</sup> ... 2.5 mm<sup>2</sup>

---

### Spare parts

Sealing screw - HC-D 7-DS-IP65 - 1686229



Sealing screw, size: Countersunk head, IP67, replacement part for D7 size HEAVYCON housing

---

Phoenix Contact 2020 © - all rights reserved  
<http://www.phoenixcontact.com>

PHOENIX CONTACT GmbH & Co. KG  
Flachsmarktstr. 8  
32825 Blomberg  
Germany  
Tel. +49 5235 300  
Fax +49 5235 3 41200  
<http://www.phoenixcontact.com>

## X-ON Electronics

Largest Supplier of Electrical and Electronic Components

*Click to view similar products for [Heavy Duty Power Connectors](#) category:*

*Click to view products by [Phoenix Contact](#) manufacturer:*

Other Similar products are found below :

[647757-1](#) [6643411-1](#) [6646058-2](#) [6646137-1](#) [6646138-1](#) [6646479-1](#) [6646608-1](#) [6646786-1](#) [6646940-1](#) [6651091-1](#) [6651525-1](#) [6651529-1](#)  
[6651788-1](#) [696475-1](#) [702-32-01109](#) [703-25-02205](#) [73000005059](#) [73000005642](#) [765-15-0080A](#) [765-16-0080B](#) [765-18-0080D](#) [829992-1](#)  
[902-77-02113](#) [PS00/A0620/6300](#) [129-1J](#) [1409400](#) [AN0024023](#) [E6374G1](#) [e6389g2](#) [157-43GW8](#) [MS3117-14AC](#) [1643543-1](#) [1650540-1](#)  
[1651811-2](#) [1766260-1](#) [1766282-1](#) [1766966-1](#) [1791340000](#) [NLDFT-3-BL-L-S120-M40A](#) [NLDFT-N-W-L-C240-M40B](#) [NLS-2-R-C240-](#)  
[M40B](#) [NLS-N-W-C240-M40B](#) [NPS-3-BL-T6](#) [1986615-1](#) [2-1589900-8](#) [2199314-1](#) [KA8102](#) [9300480317](#) [SBS50BRN#6](#) [29131](#)