

Bus system cable - SAC-5P-MR/ 0,5-923/FS CAN SCO - 1419058

Please be informed that the data shown in this PDF Document is generated from our Online Catalog. Please find the complete data in the user's documentation. Our General Terms of Use for Downloads are valid (<http://phoenixcontact.com/download>)



Bus system cable, CANopen®, DeviceNet™, 5-position, PUR halogen-free, silver-gray RAL 7001, shielded, Plug angled M12 SPEEDCON, coding: A, on Socket straight M12 SPEEDCON, coding: A, cable length: 0.5 m, Connector unshielded

RoHS



Key Commercial Data

| | |
|--------------|---|
| Packing unit | 1 pc |
| GTIN |  4 046356 543194 |
| GTIN | 4046356543194 |

Technical data

Dimensions

| | |
|-----------------|-------|
| Length of cable | 0.5 m |
|-----------------|-------|

Ambient conditions

| | |
|---------------------------------|----------------------------------|
| Ambient temperature (operation) | -25 °C ... 90 °C (Plug / socket) |
| Degree of protection | IP65 |
| | IP67 |

General

| | |
|-----------------------|--------------|
| Rated current at 40°C | 4 A |
| Rated voltage | 48 V AC |
| | 60 V DC |
| Number of positions | 5 |
| Color handle area | black |
| Coding | A - standard |
| Signal type/category | CANopen® |
| | DeviceNet™ |
| Status display | No |
| Overvoltage category | II |

Bus system cable - SAC-5P-MR/ 0,5-923/FS CAN SCO - 1419058

Technical data

General

| | |
|---------------------|------------------------|
| Degree of pollution | 3 |
| Torque | 0.4 Nm (M12 connector) |

Material

| | |
|--|---|
| Flammability rating according to UL 94 | HB |
| Contact material | CuSn |
| Contact surface material | Ni/Au |
| Contact carrier material | TPU GF |
| Material of grip body | TPU, hardly inflammable, self-extinguishing |
| Material, knurls | Zinc die-cast, nickel-plated |
| Sealing material | NBR |

Pin assignment

| | |
|---|-------------------------------------|
| Contact Color (signal designation) Contact (optional) | 1 (Plug) SR (shield) 1 (Socket) |
| | 2 (Plug) RD (V+) 2 (Socket) |
| | 3 (Plug) BK (V-) 3 (Socket) |
| | 4 (Plug) WH (CAN_H) 4 (Socket) |
| | 5 (Plug) BU (CAN_L) 5 (Socket) |

Standards and Regulations

| | |
|--|----|
| Flammability rating according to UL 94 | HB |
|--|----|

Cable

| | |
|-------------------------------------|--|
| Cable type | CANopen [®] /DeviceNet [™] , PUR, gray |
| Cable type (abbreviation) | 923 |
| UL AWM style | 21198 (80°C/300 V) |
| Cable structure | 2xAWG24/19+2xAWG22/19 |
| Conductor cross section | 2x 0.25 mm ² (Data cable) |
| | 2x 0.34 mm ² (Power supply) |
| | 1x 0.34 mm ² (Drain wire) |
| AWG signal line | 24 |
| AWG power supply | 22 |
| Conductor structure signal line | 19x 0.13 mm |
| Conductor structure, voltage supply | 19x 0.15 mm |
| Core diameter including insulation | 1.95 mm ±0.05 mm (Data cable) |
| | 1.4 mm ±0.05 mm (Power supply) |
| Wire colors | Red-black, blue-white |
| Twisted pairs | 2 cores to the pair |
| Type of pair shielding | Plastic-coated aluminum foil, aluminum side outside |
| Overall twist | 2 pairs around a drain wire in the center to the core |
| Shielding | Tinned copper braided shield |
| Optical shield covering | 80 % |
| External sheath, color | silver-gray RAL 7001 |

Bus system cable - SAC-5P-MR/ 0,5-923/FS CAN SCO - 1419058

Technical data

Cable

| | |
|---|---|
| External cable diameter D | 6.7 mm ±0.3 mm |
| Minimum bending radius, fixed installation | 5 x D |
| Minimum bending radius, flexible installation | 10 x D |
| Number of bending cycles | 5000000 |
| Bending radius | 70 mm |
| Minimum bending radius, drag chain applications | 10 x D |
| Traversing path | 4.5 m |
| Traversing rate | 3 m/s |
| Acceleration | 3 m/s ² |
| Cable weight | 90 kg/km |
| Outer sheath, material | PUR |
| Material conductor insulation | Foamed PE (Data cable) PE (Power supply) |
| Conductor material | Tin-plated Cu litz wires |
| Insulation resistance | ≥ 5 GΩ*km (Data cable) ≥ 5 GΩ*km (Power supply) |
| Loop resistance | ≤ 181.80 Ω/km (Data cable) ≤ 114.80 Ω/km (Power supply) |
| Cable capacity | nom. 40 nF/km (Data cable) |
| Wave impedance | 120 Ω ±10 % (with 1 MHz) |
| Attenuation | ≤ 22.9 dB/km (with 1 MHz) ≤ 16.4 dB/km (At 500 kHz) ≤ 9.5 dB/km (At 125 kHz) |
| Nominal voltage, cable | ≤ 300 V (Peak value, not for high-power applications) |
| Test voltage Core/Core | 2000 V (50 Hz, 1 min.) |
| Test voltage Core/Shield | 2000 V (50 Hz, 1 min.) |
| Flame resistance | UL 1581, Sec. 1060 (FT-1) IEC 60332-1 |
| Halogen-free | in accordance with DIN VDE 0472 part 815 according to IEC 60754-1 |
| Other resistance | Low adhesion |
| Ambient temperature (operation) | -40 °C ... 80 °C (cable, fixed installation) -20 °C ... 80 °C (cable, flexible installation) |

Environmental Product Compliance

| | |
|------------|---|
| China RoHS | Environmentally friendly use period: unlimited = EFUP-e |
| | No hazardous substances above threshold values |

Drawings

Bus system cable - SAC-5P-MR/ 0,5-923/FS CAN SCO - 1419058

Dimensional drawing

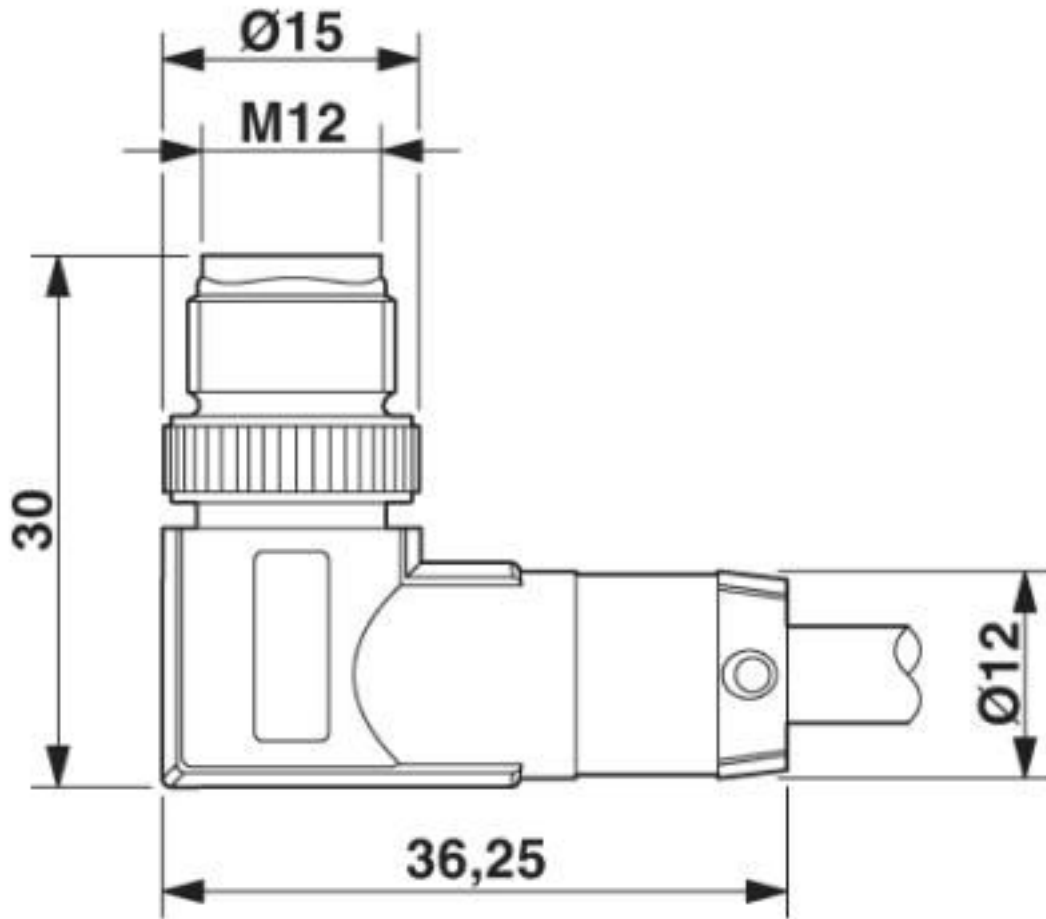

M12 x 1 male plug, angled

Dimensional drawing

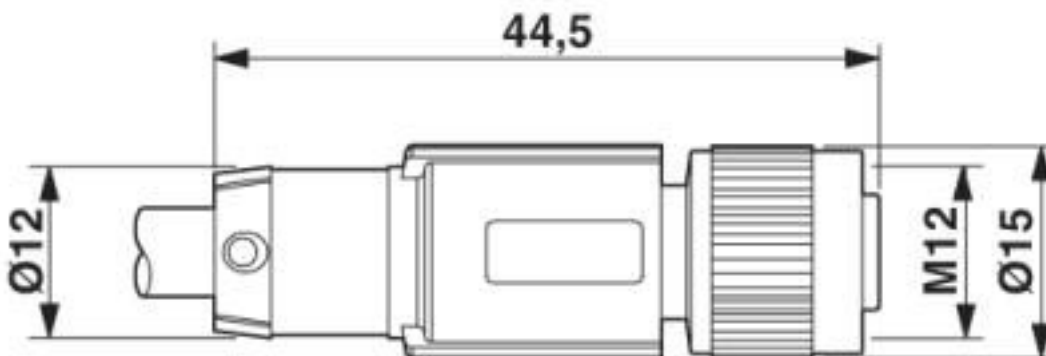

M12 x 1 socket, straight

Bus system cable - SAC-5P-MR/ 0,5-923/FS CAN SCO - 1419058

Circuit diagram

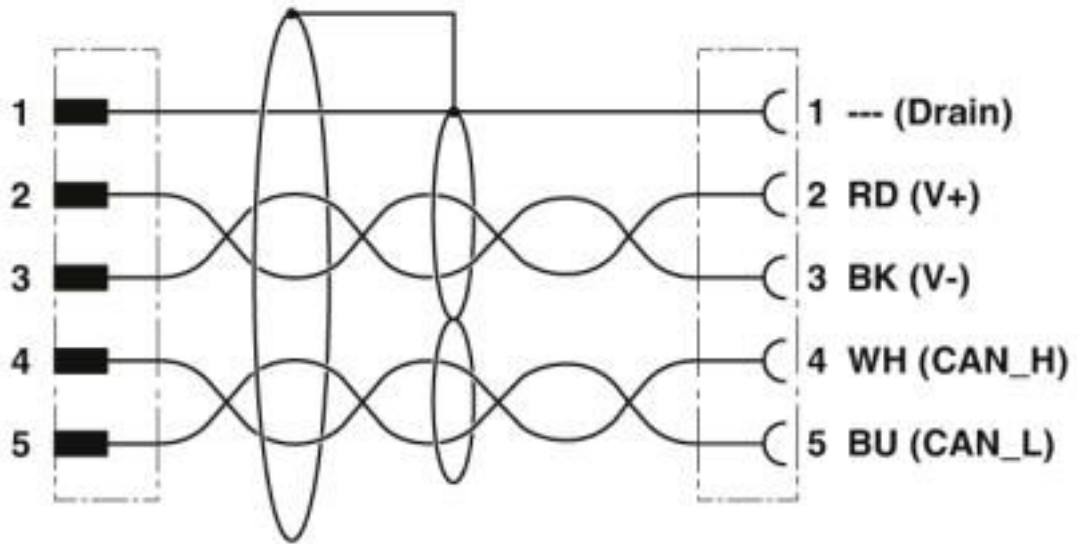

Contact assignment of the M12 plug and the M12 socket

Bus system cable - SAC-5P-MR/ 0,5-923/FS CAN SCO - 1419058

Schematic diagram

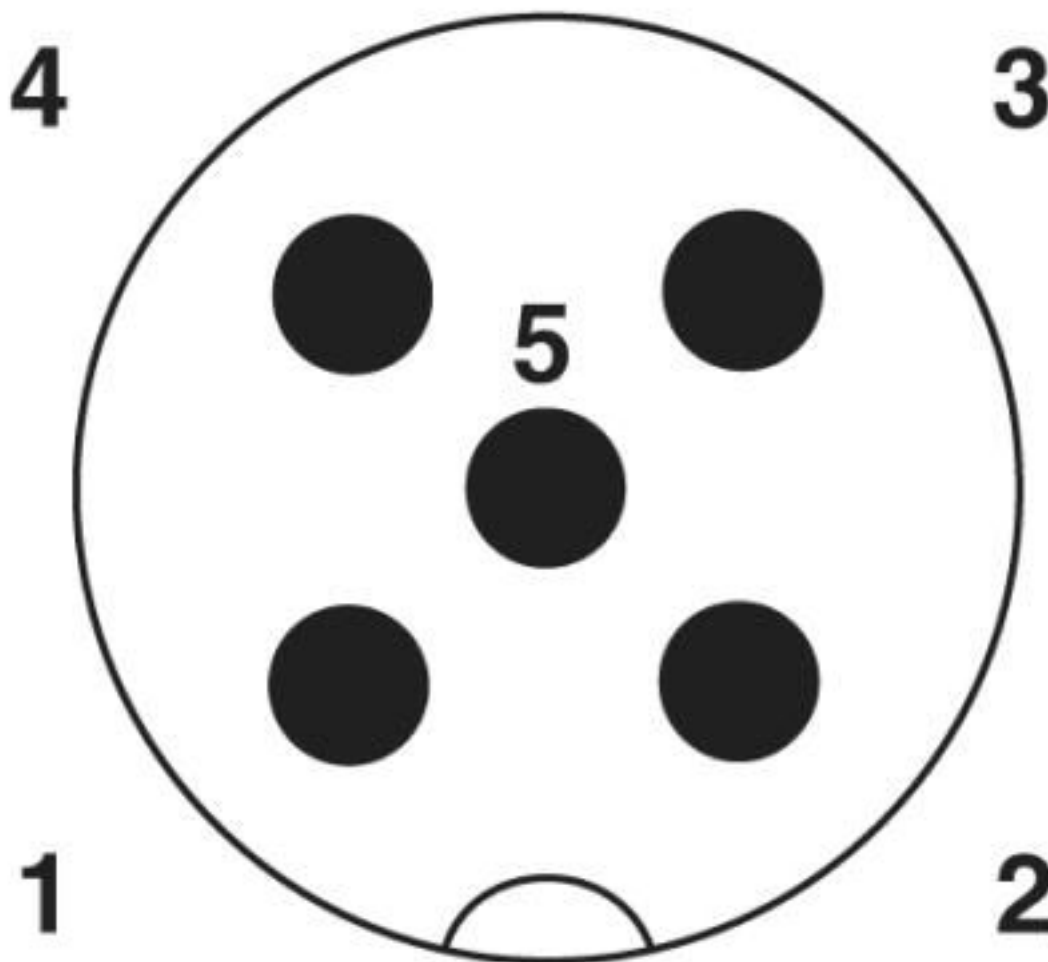

Pin assignment M12 male connector, 5-pos., A-coded, male side

Bus system cable - SAC-5P-MR/ 0,5-923/FS CAN SCO - 1419058

Schematic diagram

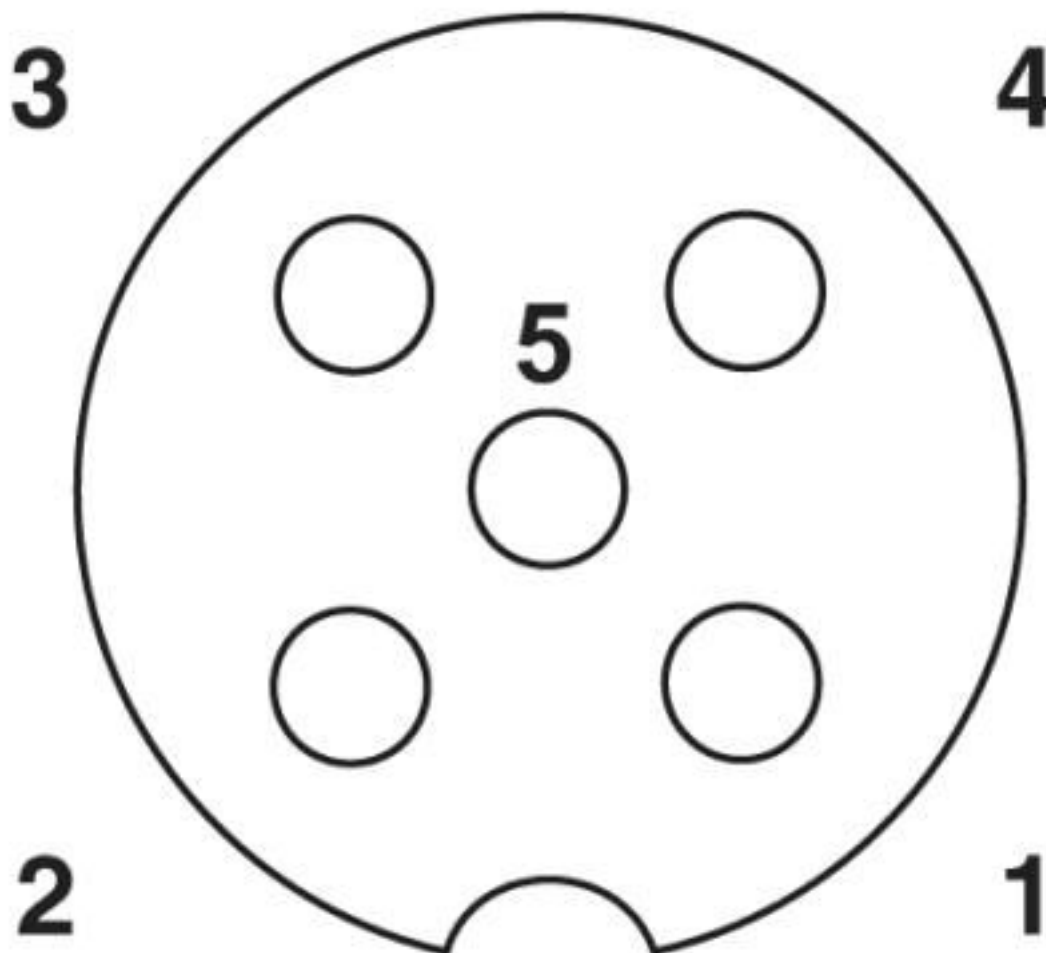

Pin assignment M12 socket, 5-pos., A-coded, socket side view

Bus system cable - SAC-5P-MR/ 0,5-923/FS CAN SCO - 1419058

Cable cross section



CANopen[®]/DeviceNet[™], PUR, gray [923]

Classifications

eCl@ss

| | |
|---------------|----------|
| eCl@ss 10.0.1 | 27060308 |
| eCl@ss 4.0 | 27060300 |
| eCl@ss 4.1 | 27060300 |
| eCl@ss 5.0 | 27060300 |
| eCl@ss 5.1 | 27060300 |
| eCl@ss 6.0 | 27279200 |
| eCl@ss 7.0 | 27279218 |
| eCl@ss 8.0 | 27279218 |
| eCl@ss 9.0 | 27060308 |

Bus system cable - SAC-5P-MR/ 0,5-923/FS CAN SCO - 1419058

Classifications

ETIM

| | |
|----------|----------|
| ETIM 2.0 | EC000830 |
| ETIM 3.0 | EC000830 |
| ETIM 4.0 | EC001855 |
| ETIM 5.0 | EC002599 |
| ETIM 6.0 | EC001262 |
| ETIM 7.0 | EC001262 |

UNSPSC

| | |
|---------------|----------|
| UNSPSC 6.01 | 26121616 |
| UNSPSC 7.0901 | 26121616 |
| UNSPSC 11 | 26121604 |
| UNSPSC 12.01 | 26121616 |
| UNSPSC 13.2 | 31251501 |
| UNSPSC 18.0 | 26121604 |
| UNSPSC 19.0 | 26121604 |
| UNSPSC 20.0 | 26121604 |
| UNSPSC 21.0 | 26121604 |

Approvals

Approvals

Approvals

UL Listed / cUL Listed / EAC-RoHS / EAC / cULus Listed

Ex Approvals

Approval details

| | | | |
|--------------------|---|---|---------------|
| UL Listed |  | http://database.ul.com/cgi-bin/XYV/template/LISEXT/1FRAME/index.htm | FILE E 221474 |
| Nominal voltage UN | 125 V | | |
| Nominal current IN | 4 A | | |

Bus system cable - SAC-5P-MR/ 0,5-923/FS CAN SCO - 1419058

Approvals

| | | | |
|--------------------|--|---|---------------|
| cUL Listed | | http://database.ul.com/cgi-bin/XYV/template/LISEXT/1FRAME/index.htm | FILE E 221474 |
| Nominal voltage UN | | 125 V | |
| Nominal current IN | | 4 A | |

| | | |
|----------|--|--------------------------|
| EAC-RoHS | | RU D- DE.HB35.B.00387 |
|----------|--|--------------------------|

| | | |
|-----|--|--------------------------|
| EAC | | RU C- DE.BL08.B.00286 |
|-----|--|--------------------------|

| | |
|--------------|--|
| cULus Listed | |
|--------------|--|

Accessories

Accessories

H-distributor

H distributor - SAC-5PH-M-F/2XF SH1 SCO - 1417414



H distributor, 5-position, shielded, Plug straight M12, coding: A, on Socket straight M12, coding: A and Socket straight M12, coding: A, Thread M12 not rotatable, Parallel distributor

Plug for cable screw gland

Screw plug - PROT-M12 MS-PA-CHAIN - 1430899

M12 sealing cap with fixing band, for sensor cables, for free M12 sockets



Protective cap

Bus system cable - SAC-5P-MR/ 0,5-923/FS CAN SCO - 1419058

Accessories

Sealing cap - PROT-M12 FS-PA-CHAIN - 1430873

M12 sealing cap made of plastic with fixing band, for sensor cables, for free M12 plugs



Safety locking

Locking clip - SAC-M12-EXCLIP-M - 1558988



Locking clip for the pin side of sensor/actuator cables with M12 connector and M12 connectors for assembly, for knurl diameter: 15 mm or for Allen key with a wrench size of 14 mm, prevents the disconnection of plug-in connections without tools

Locking clip - SAC-M12-EXCLIP-F - 1558991



Locking clip for the socket side of sensor/actuator cables with M12 connector and M12 connectors for assembly, for knurl diameter: 15 mm or for Allen key with a wrench size of 14 mm, prevents the disconnection of plug-in connections without tools

Screwdriver tools

Adapter insert - TSD-M SAC-BIT ADAPTER - 1212600



Adapter bit for TSD-M...torque tools, E6.3-1/4" drive with 4 mm hexagon to accommodate SAC bits

Tool - SAC BIT M12-D15 - 1208432



Nut for assembling sensor/actuator cables with M12 connector and M12 connectors for assembly, with a knurl diameter of 15 mm, for 4 mm hexagonal drive

T-distributor

Bus system cable - SAC-5P-MR/ 0,5-923/FS CAN SCO - 1419058

Accessories

T distributor - SAC-5P-M12T/2XM12 VP - 1541186



T distributor, 5-position, unshielded, Plug straight M12, coding: A, on Socket straight M12, coding: A and Socket straight M12, coding: A, Parallel distributor

T distributor - SAC-5PT-F/F-M VP - 1424712



T distributor, CANopen®, DeviceNet™, 5-position, unshielded, Socket straight M12, coding: A, on Socket straight M12, coding: A and Plug straight M12, coding: A, Parallel distributor

Terminal resistor

Termination resistor - SAC-5P-M12MS CAN TR - 1507816



Terminating resistor CANopen®/DeviceNet™ M12

Torque tool

Torque screwdriver - TSD 04 SAC - 1208429



Torque screwdriver, with preset torque of 0.4 Nm and 4 mm hexagonal drive for M12 connectors

Torque screwdriver - TSD-M 1,2NM - 1212224



Torque screw driver, accuracy as per EN ISO 6789 standard, adjustable from 0.3 - 1.2 Nm

Phoenix Contact 2020 © - all rights reserved
<http://www.phoenixcontact.com>

PHOENIX CONTACT GmbH & Co. KG
Flachsmarktstr. 8
32825 Blomberg
Germany
Tel. +49 5235 300
Fax +49 5235 3 41200
<http://www.phoenixcontact.com>

X-ON Electronics

Largest Supplier of Electrical and Electronic Components

Click to view similar products for [Sensor Cables / Actuator Cables](#) category:

Click to view products by [Phoenix Contact](#) manufacturer:

Other Similar products are found below :

[60963](#) [60964](#) [703000D02F2002](#) [703001D02F0602](#) [703001D02F300](#) [704000D02F120](#) [773032K02F030](#) [802027107404-1](#) [802027213811-1](#)
[804001A09M150](#) [805001A09M0502](#) [84914-0235](#) [84914-0237](#) [885030A09M020](#) [8R4J30E03C3003](#) [1200651332](#) [1200651713](#) [1200660844](#)
[1200660845](#) [1200661173](#) [1200680071](#) [1200720053](#) [1200720081](#) [1200720099](#) [1200720217](#) [1200800231](#) [1200860125](#) [1200870123](#)
[1200980102](#) [1200650267](#) [1200650298](#) [1200660183](#) [1200660782](#) [1200660849](#) [1200661295](#) [1200661297](#) [1200661342](#) [1200661343](#)
[1200670080](#) [1200670220](#) [1200680331](#) [1200720252](#) [1200730184](#) [1200860344](#) [1200870359](#) [1200870643](#) [1200980008](#) [1200980031](#)
[1210502211](#) [1210400542](#)