

Bus system cable - SAC-5P-MS/15,0-923/FR CAN SCO - 1419071

Please be informed that the data shown in this PDF Document is generated from our Online Catalog. Please find the complete data in the user's documentation. Our General Terms of Use for Downloads are valid (<http://phoenixcontact.com/download>)



Bus system cable, CANopen®, DeviceNet™, 5-position, PUR halogen-free, silver-gray RAL 7001, shielded, Plug straight M12 SPEEDCON, coding: A, on Socket angled M12 SPEEDCON, coding: A, cable length: 15 m, Connector unshielded



Key Commercial Data

Packing unit	1 pc
GTIN	
GTIN	4046356543323

Technical data

Dimensions

Length of cable	15 m
-----------------	------

Ambient conditions

Ambient temperature (operation)	-25 °C ... 90 °C (Plug / socket)
Degree of protection	IP65
	IP67

General

Rated current at 40°C	4 A
Rated voltage	48 V AC
	60 V DC
Number of positions	5
Color handle area	black
Coding	A - standard
Signal type/category	CANopen®
	DeviceNet™
Status display	No
Overvoltage category	II

Bus system cable - SAC-5P-MS/15,0-923/FR CAN SCO - 1419071

Technical data

General

Degree of pollution	3
Torque	0.4 Nm (M12 connector)

Material

Flammability rating according to UL 94	HB
Contact material	CuSn
Contact surface material	Ni/Au
Contact carrier material	TPU GF
Material of grip body	TPU, hardly inflammable, self-extinguishing
Material, knurls	Zinc die-cast, nickel-plated
Sealing material	NBR

Pin assignment

Contact Color (signal designation) Contact (optional)	1 (Plug) SR (shield) 1 (Socket)
	2 (Plug) RD (V+) 2 (Socket)
	3 (Plug) BK (V-) 3 (Socket)
	4 (Plug) WH (CAN_H) 4 (Socket)
	5 (Plug) BU (CAN_L) 5 (Socket)

Standards and Regulations

Flammability rating according to UL 94	HB
--	----

Cable

Cable type	CANopen [®] /DeviceNet [™] , PUR, gray
Cable type (abbreviation)	923
UL AWM style	21198 (80°C/300 V)
Cable structure	2xAWG24/19+2xAWG22/19
Conductor cross section	2x 0.25 mm ² (Data cable)
	2x 0.34 mm ² (Power supply)
	1x 0.34 mm ² (Drain wire)
AWG signal line	24
AWG power supply	22
Conductor structure signal line	19x 0.13 mm
Conductor structure, voltage supply	19x 0.15 mm
Core diameter including insulation	1.95 mm ±0.05 mm (Data cable)
	1.4 mm ±0.05 mm (Power supply)
Wire colors	Red-black, blue-white
Twisted pairs	2 cores to the pair
Type of pair shielding	Plastic-coated aluminum foil, aluminum side outside
Overall twist	2 pairs around a drain wire in the center to the core
Shielding	Tinned copper braided shield
Optical shield covering	80 %
External sheath, color	silver-gray RAL 7001

Bus system cable - SAC-5P-MS/15,0-923/FR CAN SCO - 1419071

Technical data

Cable

External cable diameter D	6.7 mm ±0.3 mm
Minimum bending radius, fixed installation	5 x D
Minimum bending radius, flexible installation	10 x D
Number of bending cycles	5000000
Bending radius	70 mm
Minimum bending radius, drag chain applications	10 x D
Traversing path	4.5 m
Traversing rate	3 m/s
Acceleration	3 m/s ²
Cable weight	90 kg/km
Outer sheath, material	PUR
Material conductor insulation	Foamed PE (Data cable) PE (Power supply)
Conductor material	Tin-plated Cu litz wires
Insulation resistance	≥ 5 GΩ*km (Data cable) ≥ 5 GΩ*km (Power supply)
Loop resistance	≤ 181.80 Ω/km (Data cable) ≤ 114.80 Ω/km (Power supply)
Cable capacity	nom. 40 nF/km (Data cable)
Wave impedance	120 Ω ±10 % (with 1 MHz)
Attenuation	≤ 22.9 dB/km (with 1 MHz) ≤ 16.4 dB/km (At 500 kHz) ≤ 9.5 dB/km (At 125 kHz)
Nominal voltage, cable	≤ 300 V (Peak value, not for high-power applications)
Test voltage Core/Core	2000 V (50 Hz, 1 min.)
Test voltage Core/Shield	2000 V (50 Hz, 1 min.)
Flame resistance	UL 1581, Sec. 1060 (FT-1) IEC 60332-1
Halogen-free	in accordance with DIN VDE 0472 part 815 according to IEC 60754-1
Other resistance	Low adhesion
Ambient temperature (operation)	-40 °C ... 80 °C (cable, fixed installation) -20 °C ... 80 °C (cable, flexible installation)

Environmental Product Compliance

China RoHS	Environmentally friendly use period: unlimited = EFUP-e
	No hazardous substances above threshold values

Drawings

Bus system cable - SAC-5P-MS/15,0-923/FR CAN SCO - 1419071

Dimensional drawing

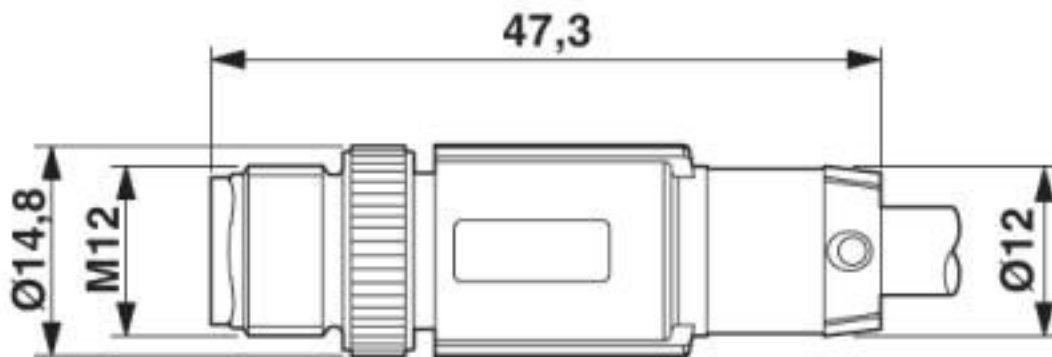

Plug, M12 x 1, straight, shielded

Dimensional drawing

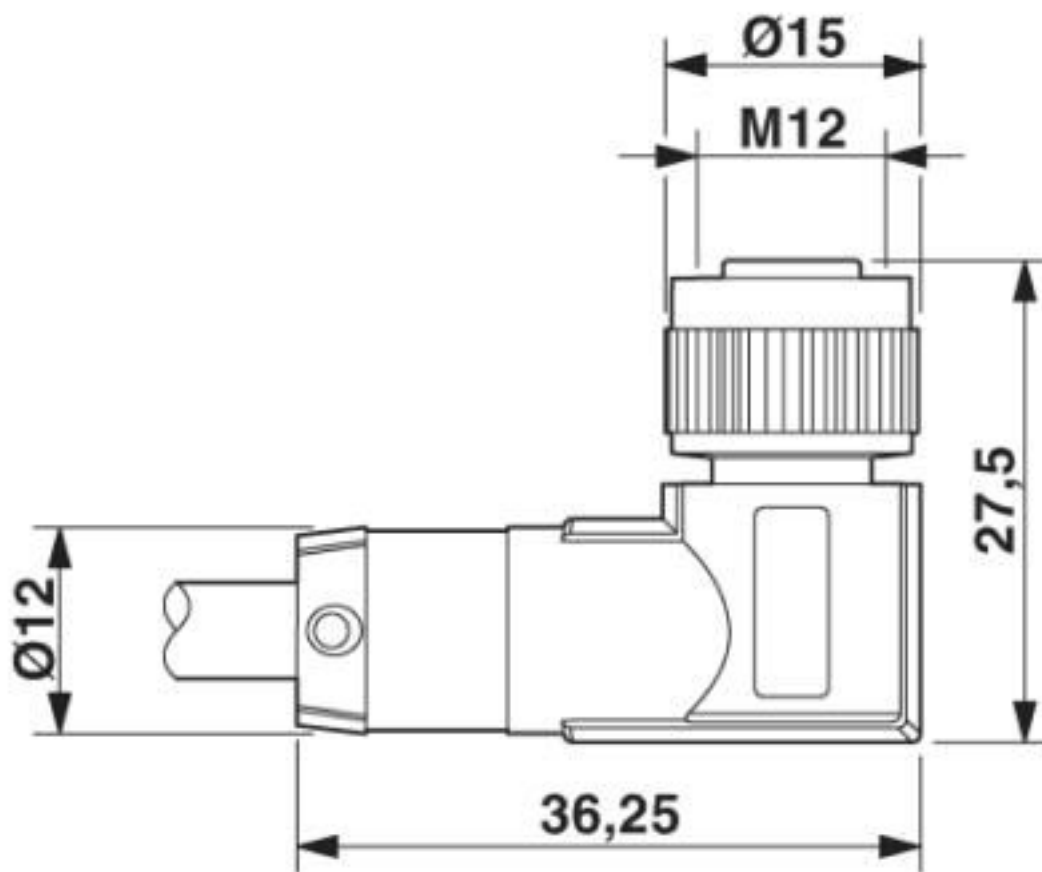

M12 x 1 socket, angled

Bus system cable - SAC-5P-MS/15,0-923/FR CAN SCO - 1419071

Circuit diagram

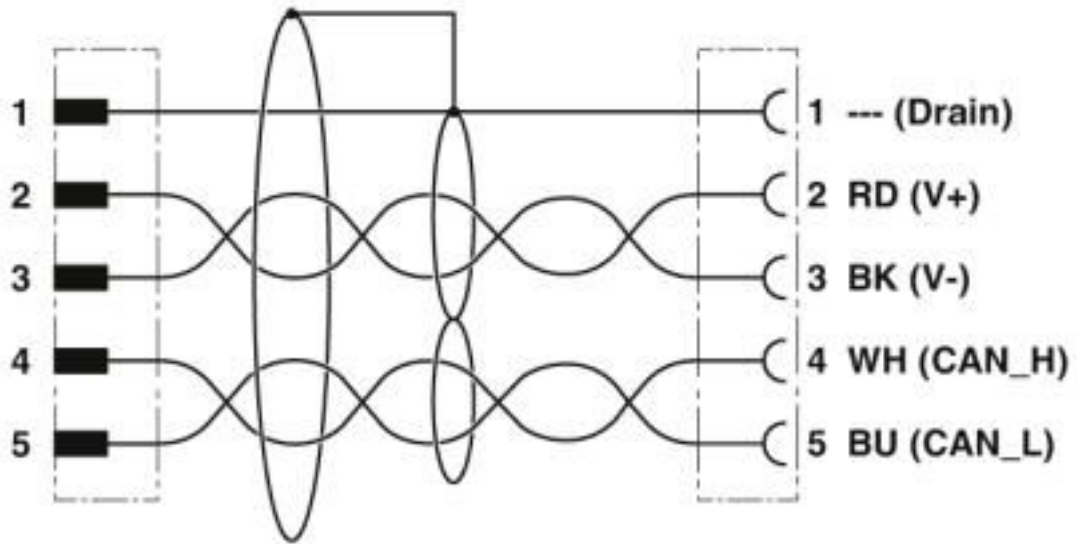

Contact assignment of the M12 plug and the M12 socket

Bus system cable - SAC-5P-MS/15,0-923/FR CAN SCO - 1419071

Schematic diagram



Pin assignment M12 male connector, 5-pos., A-coded, male side

Bus system cable - SAC-5P-MS/15,0-923/FR CAN SCO - 1419071

Schematic diagram

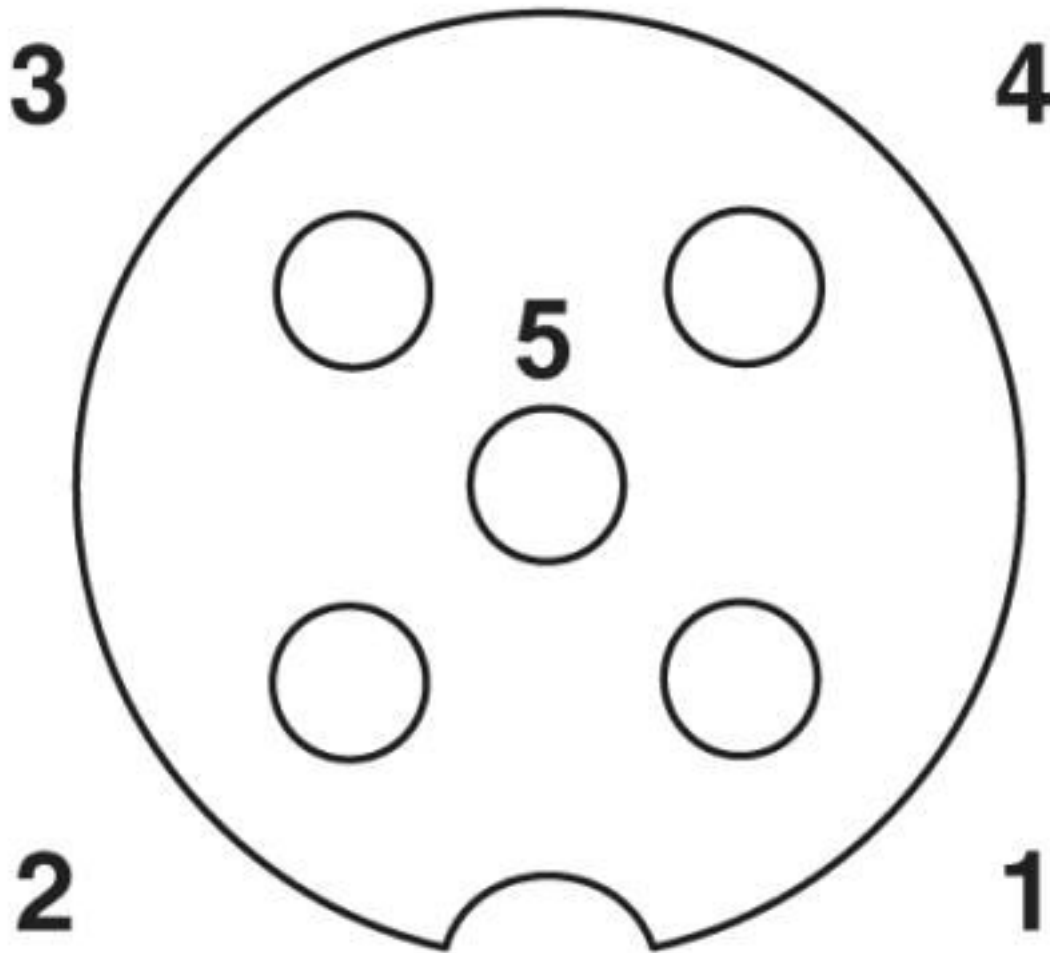

Pin assignment M12 socket, 5-pos., A-coded, socket side view

Bus system cable - SAC-5P-MS/15,0-923/FR CAN SCO - 1419071

Cable cross section



CANopen[®]/DeviceNet[™], PUR, gray [923]

Classifications

eCl@ss

eCl@ss 10.0.1	27060308
eCl@ss 4.0	27060300
eCl@ss 4.1	27060300
eCl@ss 5.0	27060300
eCl@ss 5.1	27060300
eCl@ss 6.0	27279200
eCl@ss 7.0	27279218
eCl@ss 8.0	27279218
eCl@ss 9.0	27060308

Bus system cable - SAC-5P-MS/15,0-923/FR CAN SCO - 1419071

Classifications

ETIM

ETIM 2.0	EC000830
ETIM 3.0	EC000830
ETIM 4.0	EC001855
ETIM 5.0	EC002599
ETIM 6.0	EC001262
ETIM 7.0	EC001262

UNSPSC

UNSPSC 6.01	26121616
UNSPSC 7.0901	26121616
UNSPSC 11	26121604
UNSPSC 12.01	26121616
UNSPSC 13.2	31251501
UNSPSC 18.0	26121604
UNSPSC 19.0	26121604
UNSPSC 20.0	26121604
UNSPSC 21.0	26121604

Approvals

Approvals

Approvals

UL Listed / cUL Listed / EAC-RoHS / EAC / cULus Listed

Ex Approvals

Approval details

UL Listed		http://database.ul.com/cgi-bin/XYV/template/LISEXT/1FRAME/index.htm	FILE E 221474
Nominal voltage UN	125 V		
Nominal current IN	4 A		

Bus system cable - SAC-5P-MS/15,0-923/FR CAN SCO - 1419071

Approvals

cUL Listed		http://database.ul.com/cgi-bin/XYV/template/LISEXT/1FRAME/index.htm	FILE E 221474
Nominal voltage UN		125 V	
Nominal current IN		4 A	

EAC-RoHS		RU D- DE.HB35.B.00387
----------	--	--------------------------

EAC		RU C- DE.BL08.B.00286
-----	--	--------------------------

cULus Listed	
--------------	--

Accessories

Accessories

H-distributor

H distributor - SAC-5PH-M-F/2XF SH1 SCO - 1417414



H distributor, 5-position, shielded, Plug straight M12, coding: A, on Socket straight M12, coding: A and Socket straight M12, coding: A, Thread M12 not rotatable, Parallel distributor

Plug for cable screw gland

Screw plug - PROT-M12 MS-PA-CHAIN - 1430899

M12 sealing cap with fixing band, for sensor cables, for free M12 sockets



Protective cap

Bus system cable - SAC-5P-MS/15,0-923/FR CAN SCO - 1419071

Accessories

Sealing cap - PROT-M12 FS-PA-CHAIN - 1430873

M12 sealing cap made of plastic with fixing band, for sensor cables, for free M12 plugs



Safety locking

Locking clip - SAC-M12-EXCLIP-M - 1558988



Locking clip for the pin side of sensor/actuator cables with M12 connector and M12 connectors for assembly, for knurl diameter: 15 mm or for Allen key with a wrench size of 14 mm, prevents the disconnection of plug-in connections without tools

Locking clip - SAC-M12-EXCLIP-F - 1558991



Locking clip for the socket side of sensor/actuator cables with M12 connector and M12 connectors for assembly, for knurl diameter: 15 mm or for Allen key with a wrench size of 14 mm, prevents the disconnection of plug-in connections without tools

Screwdriver tools

Adapter insert - TSD-M SAC-BIT ADAPTER - 1212600



Adapter bit for TSD-M...torque tools, E6.3-1/4" drive with 4 mm hexagon to accommodate SAC bits

Tool - SAC BIT M12-D15 - 1208432



Nut for assembling sensor/actuator cables with M12 connector and M12 connectors for assembly, with a knurl diameter of 15 mm, for 4 mm hexagonal drive

T-distributor

Bus system cable - SAC-5P-MS/15,0-923/FR CAN SCO - 1419071

Accessories

T distributor - SAC-5P-M12T/2XM12 VP - 1541186



T distributor, 5-position, unshielded, Plug straight M12, coding: A, on Socket straight M12, coding: A and Socket straight M12, coding: A, Parallel distributor

T distributor - SAC-5PT-F/F-M VP - 1424712



T distributor, CANopen®, DeviceNet™, 5-position, unshielded, Socket straight M12, coding: A, on Socket straight M12, coding: A and Plug straight M12, coding: A, Parallel distributor

Terminal resistor

Termination resistor - SAC-5P-M12MS CAN TR - 1507816



Terminating resistor CANopen®/DeviceNet™ M12

Torque tool

Torque screwdriver - TSD 04 SAC - 1208429



Torque screwdriver, with preset torque of 0.4 Nm and 4 mm hexagonal drive for M12 connectors

Torque screwdriver - TSD-M 1,2NM - 1212224



Torque screw driver, accuracy as per EN ISO 6789 standard, adjustable from 0.3 - 1.2 Nm

Phoenix Contact 2020 © - all rights reserved
<http://www.phoenixcontact.com>

PHOENIX CONTACT GmbH & Co. KG
Flachmarktstr. 8
32825 Blomberg
Germany
Tel. +49 5235 300
Fax +49 5235 3 41200
<http://www.phoenixcontact.com>

X-ON Electronics

Largest Supplier of Electrical and Electronic Components

Click to view similar products for [Sensor Cables / Actuator Cables](#) category:

Click to view products by [Phoenix Contact](#) manufacturer:

Other Similar products are found below :

[60963](#) [60964](#) [703000D02F2002](#) [703001D02F0602](#) [703001D02F300](#) [704000D02F120](#) [773032K02F030](#) [802027107404-1](#) [802027213811-1](#)
[804001A09M150](#) [805001A09M0502](#) [84914-0235](#) [84914-0237](#) [885030A09M020](#) [8R4J30E03C3003](#) [1200651332](#) [1200651713](#) [1200660844](#)
[1200660845](#) [1200661173](#) [1200680071](#) [1200720053](#) [1200720081](#) [1200720099](#) [1200720217](#) [1200800231](#) [1200860125](#) [1200870123](#)
[1200980102](#) [1200650267](#) [1200650298](#) [1200660183](#) [1200660782](#) [1200660849](#) [1200661295](#) [1200661297](#) [1200661342](#) [1200661343](#)
[1200670080](#) [1200670220](#) [1200680331](#) [1200720252](#) [1200730184](#) [1200860344](#) [1200870359](#) [1200870643](#) [1200980008](#) [1200980031](#)
[1210502211](#) [1210400542](#)