

Bus system cable - SAC-3P-M12MR/ 1,0-961/M12FS VA - 1419112

Please be informed that the data shown in this PDF Document is generated from our Online Catalog. Please find the complete data in the user's documentation. Our General Terms of Use for Downloads are valid (<http://phoenixcontact.com/download>)



Bus system cable, PROFIBUS PA (31.25 kbps), 3-position, PVC, blue RAL 5015, shielded, Plug angled M12, coding: A, on Socket straight M12, coding: A, cable length: 1 m, For Ex area with high-grade steel knurl



Key Commercial Data

Packing unit	1 pc
GTIN	
GTIN	4046356541794

Technical data

Dimensions

Length of cable	1 m
Stripping length of the free conductor end	50 mm

Ambient conditions

Ambient temperature (operation)	-25 °C ... 90 °C (Plug / socket)
Degree of protection	IP65
	IP67
	IP68
	IP69K

General

Note	For applications in circuits of intrinsic safety protection type "i". Electrical values following EN 60079-14.
Rated current at 40°C	4 A
Rated voltage	48 V AC
	60 V DC
Number of positions	3
Color handle area	black
Coding	B - inverse

Bus system cable - SAC-3P-M12MR/ 1,0-961/M12FS VA - 1419112

Technical data

General

Signal type/category	PROFIBUS PA, 31.25 kbps
Status display	No
Overvoltage category	II
Degree of pollution	3
Insertion/withdrawal cycles	≥ 100
Torque	0.4 Nm (M12 connector)

Material

Flammability rating according to UL 94	HB
Contact material	CuSn
Contact surface material	Ni/Au
Contact carrier material	TPU GF
Material of grip body	TPU, hardly inflammable, self-extinguishing
Material, knurls	Stainless steel
Sealing material	NBR

Pin assignment

Contact Color (signal designation) Contact (optional)	1 (Plug) OG (DATA+) 1 (Socket)
	3 (Plug) BU (DATA-) 3 (Socket)
	4 (Plug) SR (shield) 4 (Socket)

Standards and Regulations

Flammability rating according to UL 94	HB
--	----

Cable

Cable type	Fieldbus FOUNDATION/PROFIBUS PA, blue
Cable type (abbreviation)	961
Cable structure	2xAWG18/7 + 1xAWG20/7
Conductor cross section	2x 0.75 mm ² (Signal line)
	1x 0.5 mm ² (Drain wire)
AWG signal line	18
Conductor structure signal line	7x 0.40 mm
Core diameter including insulation	2.24 mm ±0.05 mm
Thickness, insulation	0.5 mm
Wire colors	Blue, orange
Twisted pairs	2 cores to the pair
Overall twist	One pair with one drain wire and fillers for core
Shielding	Plastic-coated aluminum foil with a drain wire
Optical shield covering	100 %
External sheath, color	blue RAL 5015
Outer sheath thickness	1 mm
External cable diameter D	7.5 mm ±0.25 mm
Smallest bending radius, fixed installation	75 mm

Bus system cable - SAC-3P-M12MR/ 1,0-961/M12FS VA - 1419112

Technical data

Cable

Cable weight	56.552 kg/km
Tensile strength GRP	260 N
Outer sheath, material	PVC
Material conductor insulation	PO (Signal line)
Conductor material	Tin-plated Cu litz wires
Conductor resistance	≤ 19.35 Ω/km (Signal line)
	26 Ω/km (shield)
Working capacitance	78 nF (at 1 kHz)
Cable capacity	147 pF/m (at 1 kHz, core/shield)
	≤ 3.94 pF/m (capacitance unbalance)
Signal speed	0.66 c
Shield attenuation	3 dB/km (at 39 kHz)
Cable impedance	100 Ω ±20 % (At 31.25 kHz)
Conductor inductance	0.6233 μH/m
Nominal voltage, cable	300 V
Special properties	UL standards PLTC-ER and ITC
Flame resistance	UL 1685 (CSA FT 4)
	UL 1685 (vertical tray)
	UL 1666 (riser)
Ambient temperature (operation)	-40 °C ... 105 °C (cable, fixed installation)

Environmental Product Compliance

REACH SVHC	Lead 7439-92-1
China RoHS	Environmentally Friendly Use Period = 50 years
	For details about hazardous substances go to tab "Downloads", Category "Manufacturer's declaration"

Drawings

Bus system cable - SAC-3P-M12MR/ 1,0-961/M12FS VA - 1419112

Dimensional drawing

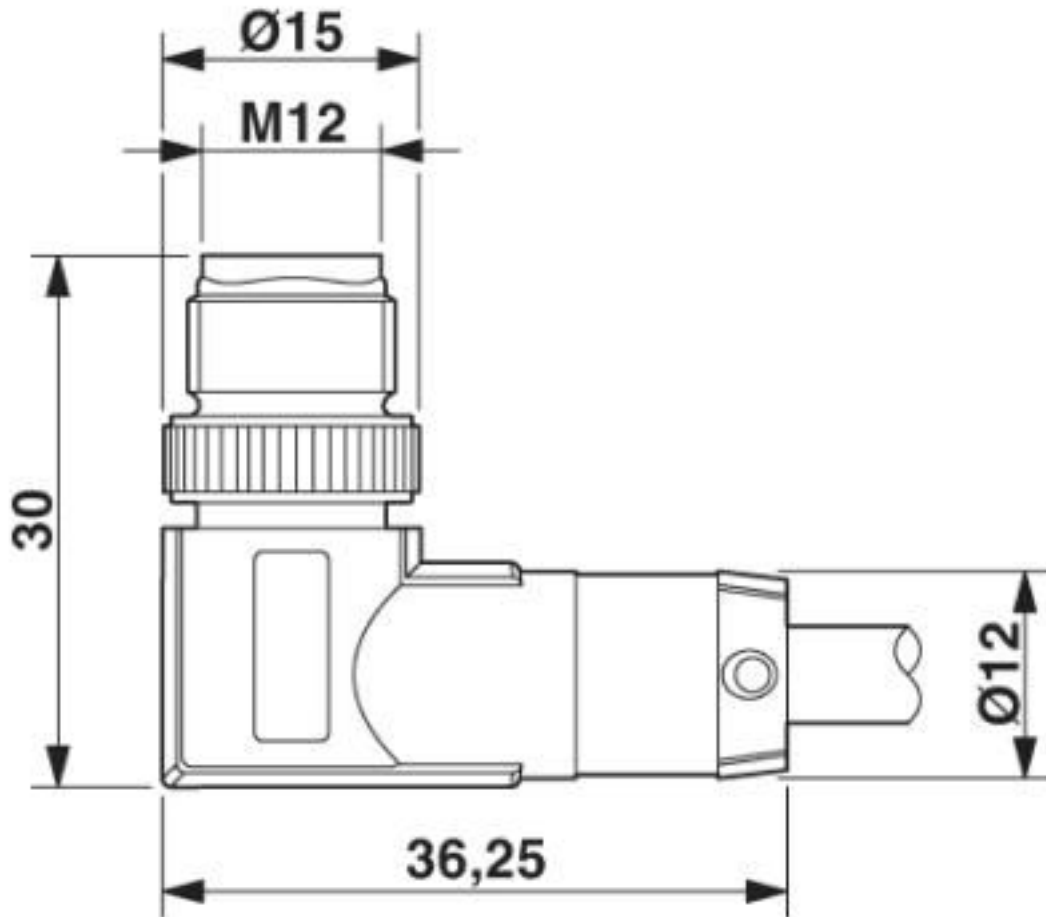

M12 x 1 male plug, angled

Dimensional drawing

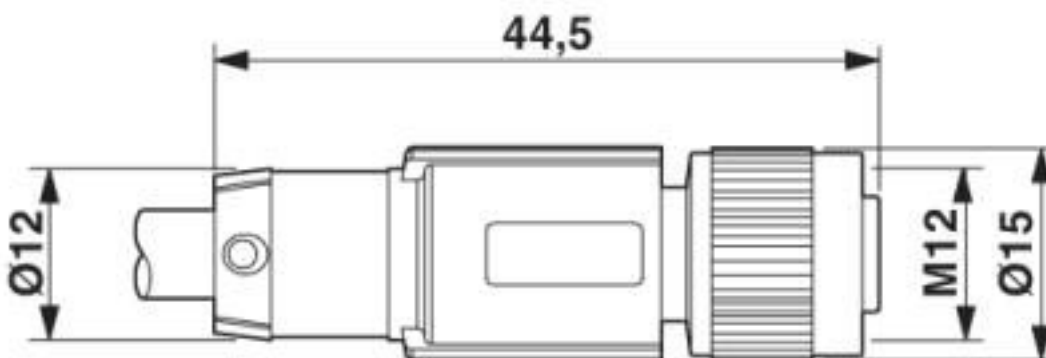

M12 x 1 socket, straight

Bus system cable - SAC-3P-M12MR/ 1,0-961/M12FS VA - 1419112

Circuit diagram

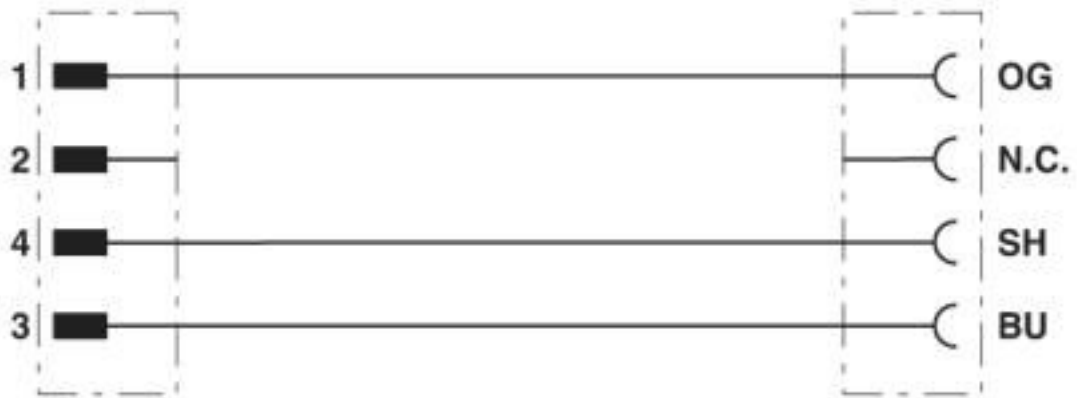

Contact assignment of the M12 connector and the M12 socket

Schematic diagram

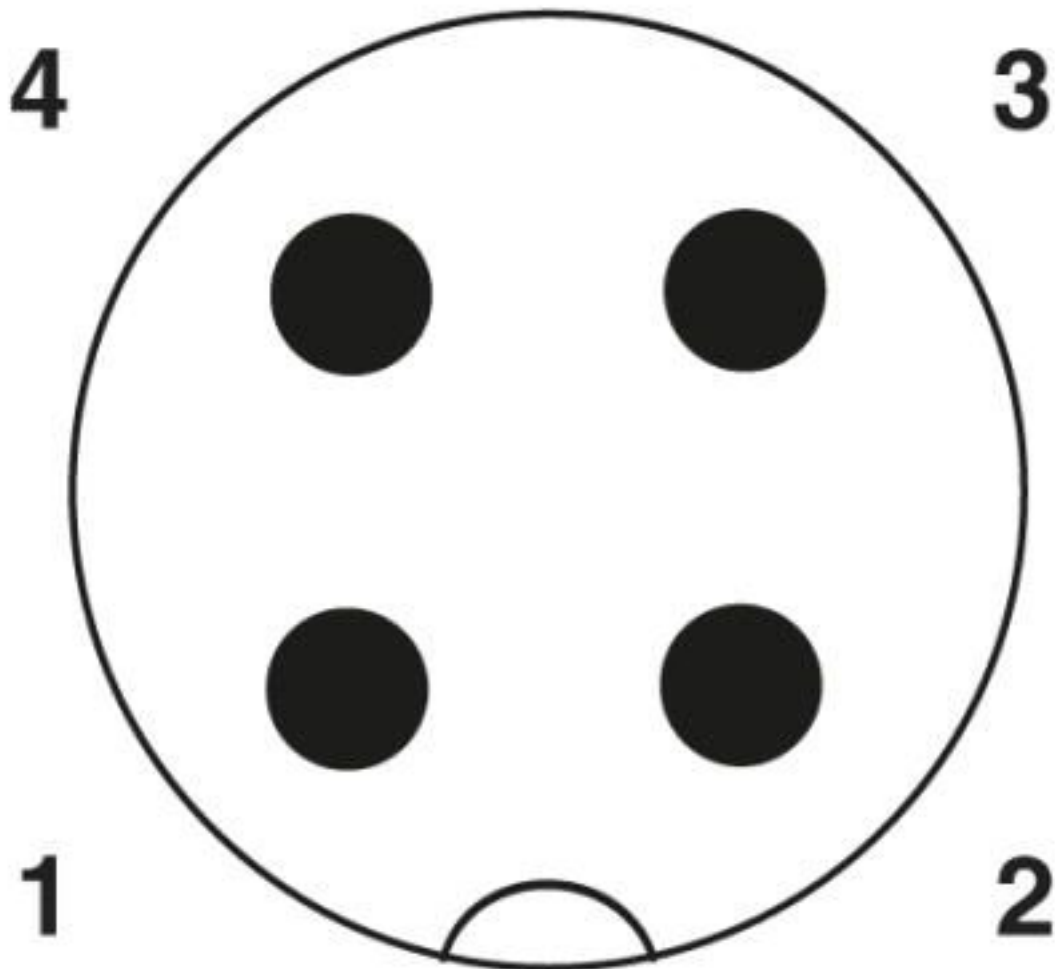

Pin assignment M12 plug, 3-pos., A-coded, view male side

Bus system cable - SAC-3P-M12MR/ 1,0-961/M12FS VA - 1419112

Schematic diagram

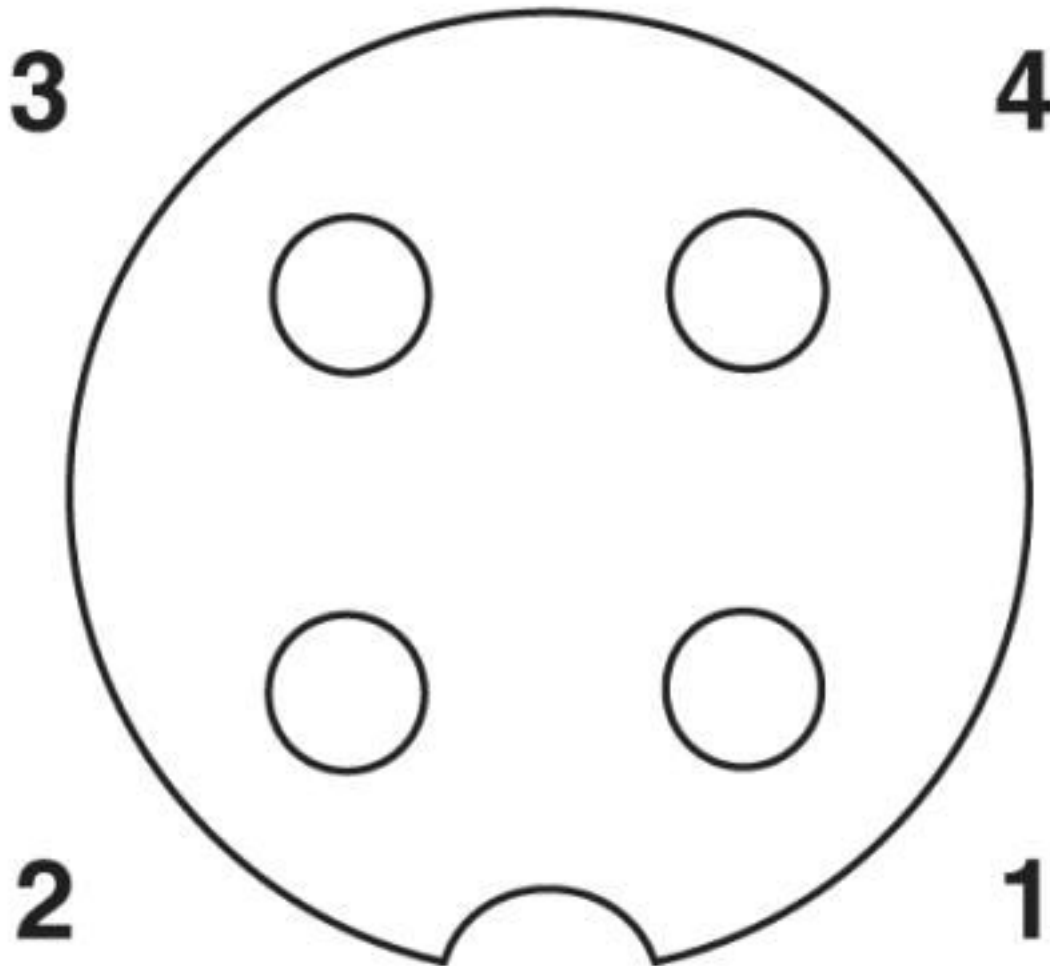

Pin assignment M12 socket, 3-pos., A-coded, view female side

Bus system cable - SAC-3P-M12MR/ 1,0-961/M12FS VA - 1419112

Cable cross section

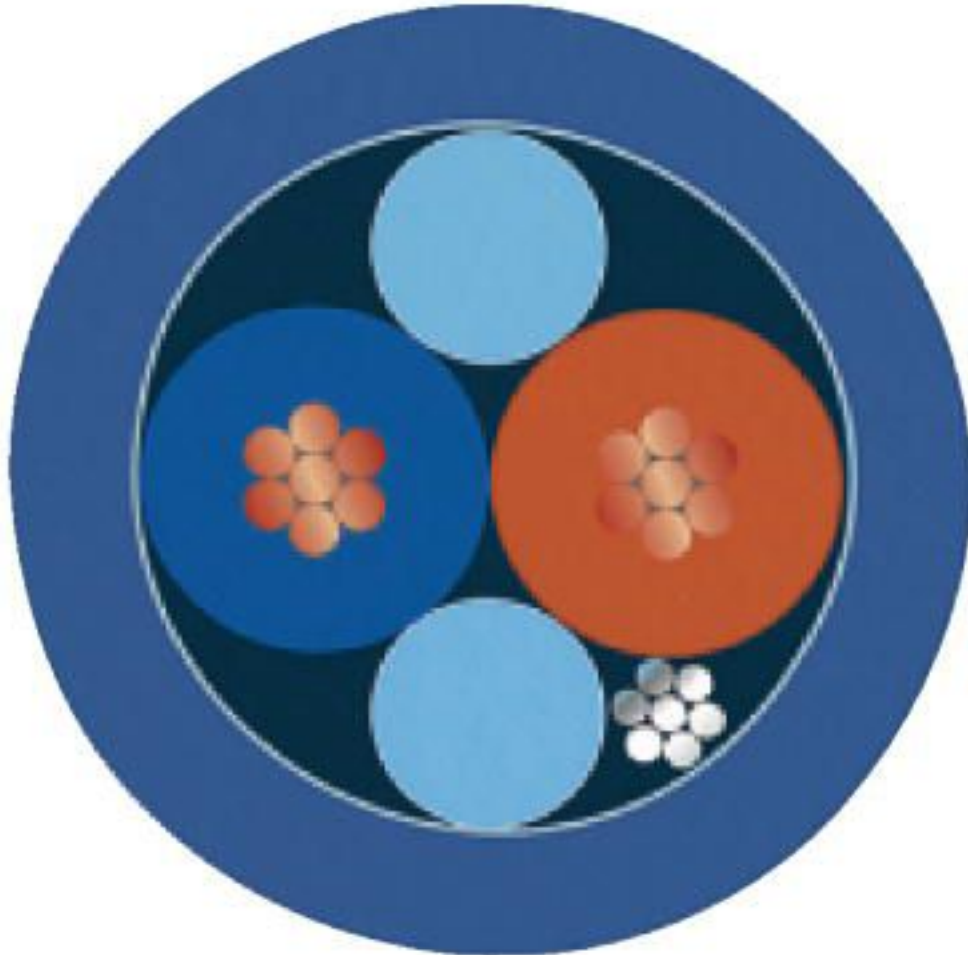

Fieldbus FOUNDATION/PROFIBUS PA, blue [961]

Classifications

eCl@ss

eCl@ss 10.0.1	27060308
eCl@ss 4.0	27060300
eCl@ss 4.1	27060300
eCl@ss 5.0	27060300
eCl@ss 5.1	27060300
eCl@ss 6.0	27279200
eCl@ss 7.0	27279218
eCl@ss 8.0	27279218
eCl@ss 9.0	27060308

Bus system cable - SAC-3P-M12MR/ 1,0-961/M12FS VA - 1419112

Classifications

ETIM

ETIM 2.0	EC000830
ETIM 3.0	EC000830
ETIM 4.0	EC001855
ETIM 5.0	EC002599
ETIM 6.0	EC001262
ETIM 7.0	EC001262

UNSPSC

UNSPSC 6.01	26121616
UNSPSC 7.0901	26121616
UNSPSC 11	26121604
UNSPSC 12.01	26121616
UNSPSC 13.2	31251501
UNSPSC 18.0	26121604
UNSPSC 19.0	26121604
UNSPSC 20.0	26121604
UNSPSC 21.0	26121604

Approvals

Approvals

Approvals

EAC-RoHS / EAC

Ex Approvals

Approval details

EAC-RoHS		RU D- DE.HB35.B.00387
----------	--	--------------------------

EAC		RU C- DE.BL08.B.00286
-----	--	--------------------------

Accessories

Accessories

Screwdriver tools

Bus system cable - SAC-3P-M12MR/ 1,0-961/M12FS VA - 1419112

Accessories

Adapter insert - TSD-M SAC-BIT ADAPTER - 1212600



Adapter bit for TSD-M...torque tools, E6.3-1/4" drive with 4 mm hexagon to accommodate SAC bits

Adapter - SAC BIT M12-W14 - 1212513



Nut for assembling sensor/actuator cables with M12 connector and M12 connectors for assembly, with a hexagonal knurl wrench size of 14 mm, with 4 mm hexagonal drive

Torque tool

Torque screwdriver - TSD 04 SAC - 1208429



Torque screwdriver, with preset torque of 0.4 Nm and 4 mm hexagonal drive for M12 connectors

Torque screwdriver - TSD-M 1,2NM - 1212224



Torque screw driver, accuracy as per EN ISO 6789 standard, adjustable from 0.3 - 1.2 Nm

Phoenix Contact 2020 © - all rights reserved
<http://www.phoenixcontact.com>

PHOENIX CONTACT GmbH & Co. KG
Flachsmarktstr. 8
32825 Blomberg
Germany
Tel. +49 5235 300
Fax +49 5235 3 41200
<http://www.phoenixcontact.com>

X-ON Electronics

Largest Supplier of Electrical and Electronic Components

Click to view similar products for [Sensor Cables / Actuator Cables](#) category:

Click to view products by [Phoenix Contact](#) manufacturer:

Other Similar products are found below :

[60963](#) [60964](#) [703000D02F2002](#) [703001D02F0602](#) [703001D02F300](#) [704000D02F120](#) [773032K02F030](#) [802027107404-1](#) [802027213811-1](#)
[804001A09M150](#) [805001A09M0502](#) [84914-0235](#) [84914-0237](#) [885030A09M020](#) [8R4J30E03C3003](#) [1200651332](#) [1200651713](#) [1200660844](#)
[1200660845](#) [1200661173](#) [1200680071](#) [1200720053](#) [1200720081](#) [1200720099](#) [1200720217](#) [1200800231](#) [1200860125](#) [1200870123](#)
[1200980102](#) [1200650267](#) [1200650298](#) [1200660183](#) [1200660782](#) [1200660849](#) [1200661295](#) [1200661297](#) [1200661342](#) [1200661343](#)
[1200670080](#) [1200670220](#) [1200680331](#) [1200720252](#) [1200730184](#) [1200860344](#) [1200870359](#) [1200870643](#) [1200980008](#) [1200980031](#)
[1210502211](#) [1210400542](#)