

Housing screw connection - SACC-BP-F-M12/ SMD-1,6/2,3-9TIP - 1419570

Please be informed that the data shown in this PDF Document is generated from our Online Catalog. Please find the complete data in the user's documentation. Our General Terms of Use for Downloads are valid (<http://phoenixcontact.com/download>)



M12 threaded sleeve with tolerance-compensating function, for straight, SMD-solderable M12 socket contact inserts. Suitable for 1.6 mm ... 2.3 mm thick front plates.

Your advantages

- Tolerance-compensating function between PCB and housing
- Prevents force being applied to soldering spots
- Easy integration thanks to tool-free mounting
- Optional port sealing without protective cap



Key Commercial Data

Packing unit	10 pc
Minimum order quantity	10 pc
GTIN	
GTIN	4055626207056

Technical data

Environmental Product Compliance

REACH SVHC	Lead 7439-92-1
China RoHS	Environmentally Friendly Use Period = 50 years
	For details about hazardous substances go to tab "Downloads", Category "Manufacturer's declaration"

Drawings

Housing screw connection - SACC-BP-F-M12/ SMD-1,6/2,3-9TIP - 1419570

Dimensional drawing

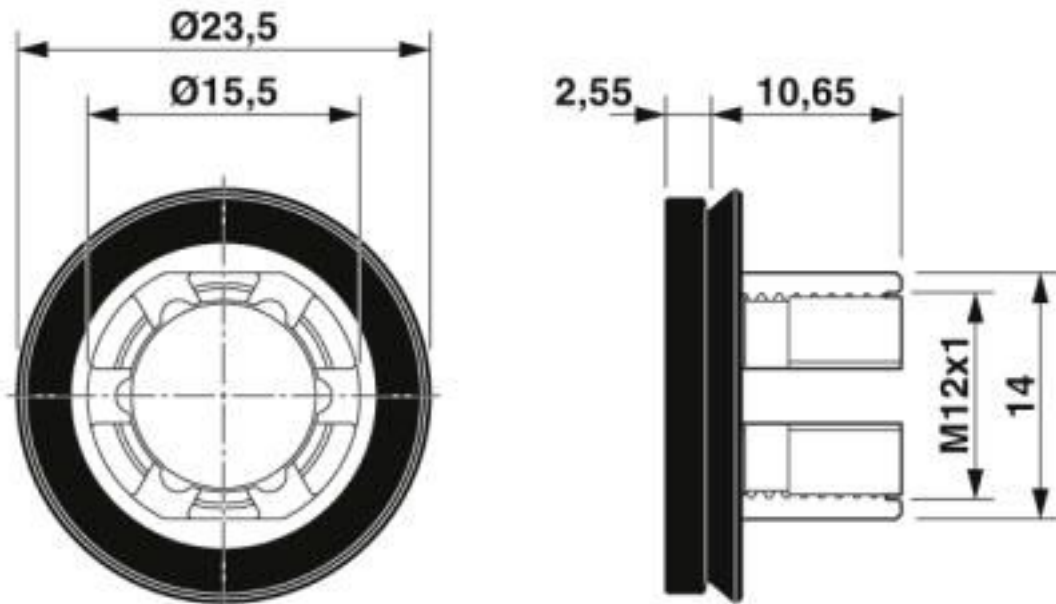

Dimensional drawing

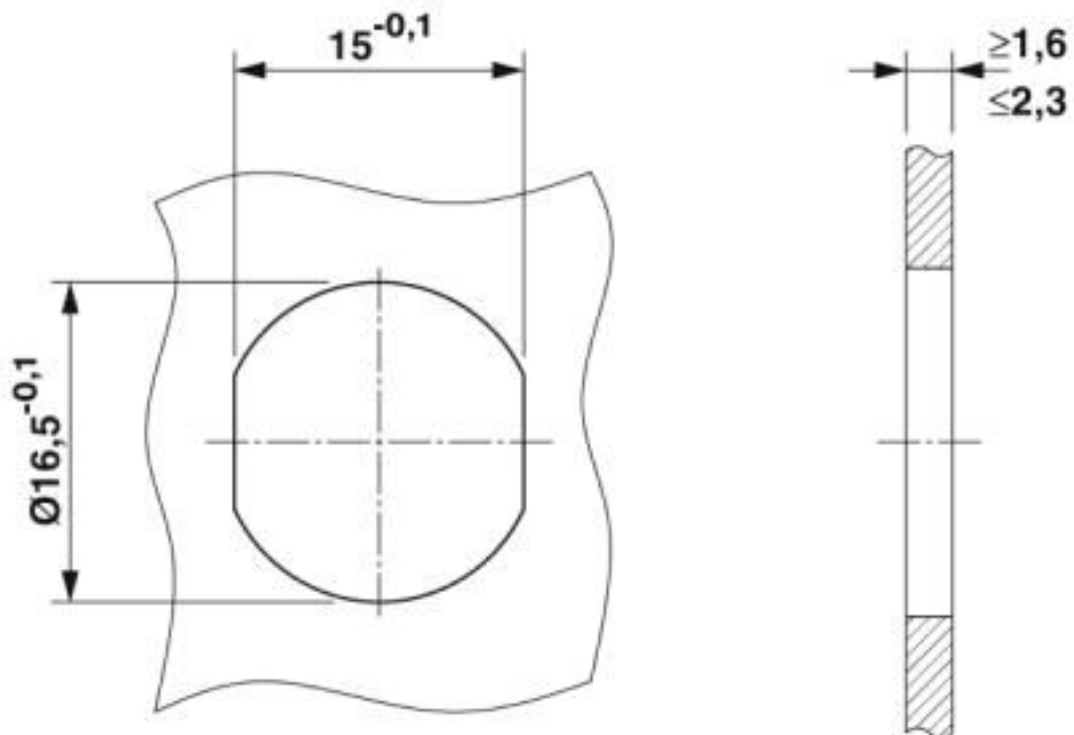

Mounting cutout

Housing screw connection - SACC-BP-F-M12/ SMD-1,6/2,3-9TIP - 1419570

Classifications

eCl@ss

eCl@ss 10.0.1	23100602
eCl@ss 4.0	23100600
eCl@ss 4.1	23100600
eCl@ss 5.0	23100600
eCl@ss 5.1	23100600
eCl@ss 6.0	23100600
eCl@ss 7.0	23100602
eCl@ss 8.0	23100602
eCl@ss 9.0	23100602

ETIM

ETIM 4.0	EC001855
ETIM 5.0	EC002350
ETIM 6.0	EC002350
ETIM 7.0	EC002350

Accessories

Accessories

Panel mounting base

Housing screw connection - SACC-BP-F-FIX/NUT-BK-SMD - 1419568



Fixing sleeve for M12 housing screw connection with tolerance-compensating function, for SMD-solderable M12 socket contact inserts.

Housing screw connection - SACC-BP-F-FIX/NUT-CY-SMD - 1419565



Fixing sleeve for M12 housing screw connection with tolerance-compensating function, for SMD-solderable M12 socket contact inserts.

Housing screw connection - SACC-BP-F-M12/ SMD-1,6/2,3-9TIP - 1419570

Accessories

Housing screw connection - SACC-BP-F-FIX/NUT-GN-SMD - 1419566



Fixing sleeve for M12 housing screw connection with tolerance-compensating function, for SMD-solderable M12 socket contact inserts.

Housing screw connection - SACC-BP-F-FIX/NUT-VT-SMD - 1419567



Fixing sleeve for M12 housing screw connection with tolerance-compensating function, for SMD-solderable M12 socket contact inserts.

Phoenix Contact 2020 © - all rights reserved
<http://www.phoenixcontact.com>

PHOENIX CONTACT GmbH & Co. KG
Flachsmarktstr. 8
32825 Blomberg
Germany
Tel. +49 5235 300
Fax +49 5235 3 41200
<http://www.phoenixcontact.com>

X-ON Electronics

Largest Supplier of Electrical and Electronic Components

Click to view similar products for [Circular Metric Connectors](#) category:

Click to view products by [Phoenix Contact](#) manufacturer:

Other Similar products are found below :

[600X518037X](#) [6STD15PCR99B70A](#) [8R4000A16M020](#) [8R5000A16M005](#) [1200910002](#) [1203580030](#) [1200910008](#) [1200910011](#) [1300140094](#)
[130203-0054](#) [1300140026](#) [1300150099](#) [RF-12S1N8A90DU](#) [1-3637-600-5205](#) [1612618](#) [21036836414](#) [8R4006A16M010](#) [1604232](#)
[1R3006A20M005](#) [RF-12P1N8A90DU](#) [41-40011](#) [42-00006](#) [42-01015](#) [4-22279-4](#) [4-22281-1](#) [4-22284-9](#) [43-00113](#) [43-01088](#) [43-01203](#) [41-](#)
[40013](#) [42-00008](#) [43-00343](#) [43-01026](#) [43-01162](#) [43-01173](#) [43-10000](#) [XS3P-M421-2](#) [600X518050X](#) [SACC-DSI-FS-5P-PG9-L180 SC](#)
[8R5006A16M020](#) [8R5006A16M005](#) [8R4000A16M010](#) [6-22279-3](#) [1605332](#) [N03FA03144](#) [1300140077](#) [43-16213](#) [43-01338](#) [XS2RD4265](#)
[XS2R-D426-1](#)