

Contact insert - HC-Q04-I-CT-M - 1419898

Please be informed that the data shown in this PDF Document is generated from our Online Catalog. Please find the complete data in the user's documentation. Our General Terms of Use for Downloads are valid (<http://phoenixcontact.com/download>)



Contact insert, number of positions: 4, size: D7, number of connections per position: 1, Pin, Crimp connection, 830 V, 40 A, 1.5 mm² ... 6 mm², application: Power, Only suitable for plastic housings



COMPLIANT

Key Commercial Data

Packing unit	1 pc
GTIN	 4 055626 256177
GTIN	4055626256177

Technical data

General

Note	for HC-STA-D07 housing, CK 4,0 crimp contacts
	Connectors may be operated only when there is no load/voltage.
	Order crimp contacts separately
Connection method	Crimp connection
Number of connections per position	1
Degree of pollution	3
Overvoltage category	III
Number of positions	4
Insertion/withdrawal cycles	≥ 500
Size	D7
Contact numbering	1 - 4
Conductor cross section	1.5 mm ² ... 6 mm ²
Connection cross section AWG	16 ... 10
Stripping length of the individual wire	9 mm (1.5 ... 6.0 mm ²)
Assembly instructions	To ensure correct use, installation in housing with IP54 protection or better is required

Ambient conditions

Contact insert - HC-Q04-I-CT-M - 1419898

Technical data

Ambient conditions

Degree of protection (IP)	IP20
Ambient temperature (operation)	-40 °C ... 125 °C (including heating up of contacts)

Material data

Seal material	NBR, conductive
Contact material	Copper alloy
Contact surface material	Ag
Contact carrier material	PC

Electrical characteristics

Rated voltage (III/3)	830 V
Rated surge voltage	8 kV
Rated current	40 A

Standards and Regulations

Constructional and testing regulations	DIN VDE 0627/86
	DIN VDE 0110/02.79
	DIN VDE 0110-1/04.97
	IEC 60664-1, DIN IEC 60512
	IEC 60352
Flammability rating according to UL 94	V0

Environmental Product Compliance

China RoHS	Environmentally friendly use period: unlimited = EFUP-e
	No hazardous substances above threshold values

Drawings

Contact insert - HC-Q04-I-CT-M - 1419898

Schematic diagram

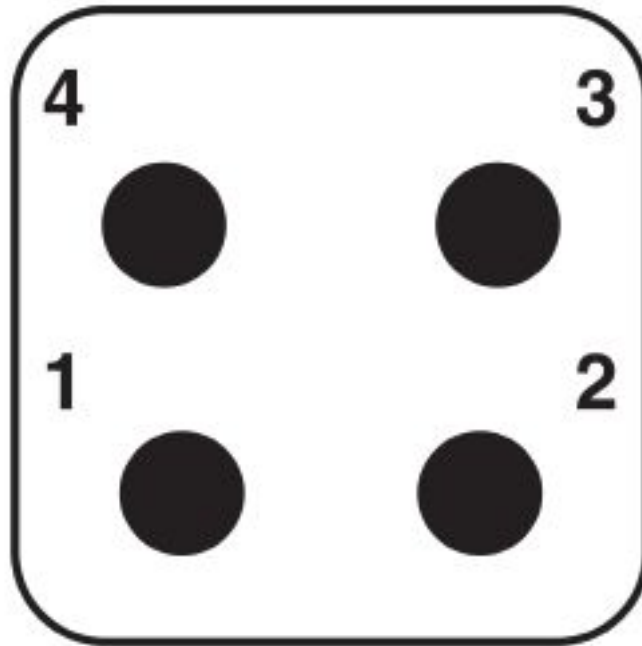

Contact insert - HC-Q04-I-CT-M - 1419898

Diagram

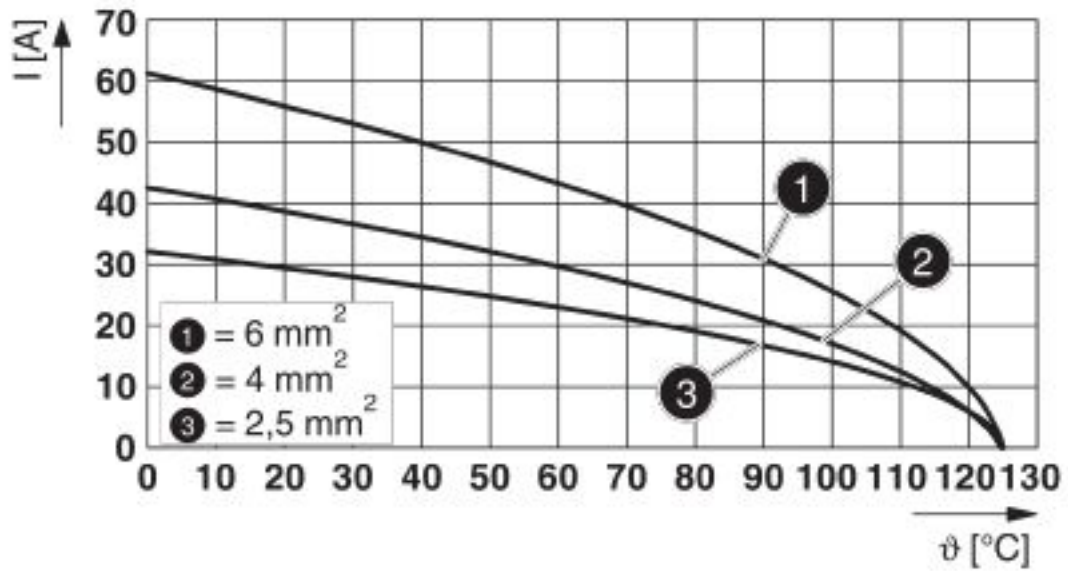

Derating diagram

Dimensional drawing

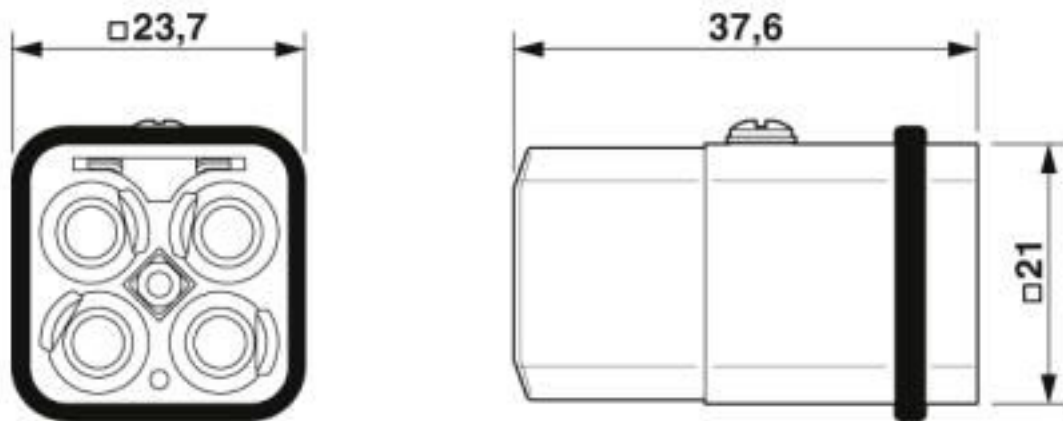

Male insert

Classifications

eCl@ss

eCl@ss 10.0.1	27440205
eCl@ss 4.0	27140800
eCl@ss 4.1	27140800
eCl@ss 5.0	27143400
eCl@ss 5.1	27261200
eCl@ss 6.0	27261200

Contact insert - HC-Q04-I-CT-M - 1419898

Classifications

eCl@ss

eCl@ss 7.0	27440205
eCl@ss 8.0	27440205
eCl@ss 9.0	27440205

ETIM

ETIM 5.0	EC000438
ETIM 6.0	EC000438
ETIM 7.0	EC000438

UNSPSC

UNSPSC 13.2	39121522
UNSPSC 18.0	39121522
UNSPSC 19.0	39121522
UNSPSC 20.0	39121522
UNSPSC 21.0	39121522

Approvals

Approvals

Approvals

EAC / EAC / UL Recognized

Ex Approvals

Approval details

EAC		RU C- DE.AI30.B.01102
-----	---	--------------------------

EAC		RU C- DE.BL08.B.00511
-----	---	--------------------------

UL Recognized		http://database.ul.com/cgi-bin/XYV/template/LISEXT/1FRAME/index.htm	E118976
Nominal voltage UN	600 V		

Contact insert - HC-Q04-I-CT-M - 1419898

Approvals

Nominal current IN	50 A
mm ² /AWG/kcmil	8

Accessories

Accessories

Coding element

Coding profile - HC-MOD-K-CP - 1408562

Coding profile for HC-MOD-K... housing



Crimp contact

Crimp contact - CK4,0-ED-1,50ST AG - 1663239



Turned 4.0 crimp contact, individual male contact, core diameter 1.5 mm², silver-plated

Crimp contact - CK4,0-ED-2,50ST AG - 1663242



Turned 4.0 crimp contact, individual male contact, core diameter 2.50 mm², silver-plated

Crimp contact - CK4,0-ED-4,00ST AG - 1663255



Turned 4.0 crimp contact, individual male contact, core diameter 4.00 mm², silver-plated

Contact insert - HC-Q04-I-CT-M - 1419898

Accessories

Crimp contact - CK4,0-ED-6,00ST AG - 1663268



Turned 4.0 crimp contact, individual male contact, core diameter 6.00 mm², silver-plated

Crimp contact - CK4,0-ED-10,00ST AG - 1586198



Turned 4.0 crimp contact, single male contact, 10 mm² conductor cross section, silver-plated

Crimping tool

Crimping pliers - CRIMPFOX-TC 4 - 1212113



Crimping pliers, for CK 1,6-ED..., CK 2,5-ED..., CK 4,0-ED... turned contacts, 4 marked die stations, unlockable pressure lock, lateral entry, incl. positioning tool

Crimping pliers - CRIMPFOX-TC 10 - 1212114



Crimping pliers, for turned contacts with a pin diameter of 4.0 mm, two marked die stations, pressure lock can be released, lateral entry, incl. positioning help

Mounting material

Sealing screw - HC-D 7-DS-IP65 - 1686229



Sealing screw, size: Countersunk head, IP67, replacement part for D7 size HEAVYCON housing

Seal

Contact insert - HC-Q04-I-CT-M - 1419898

Accessories

Profile gasket - HC-D07-SP-RBK - 1419622



Profile gasket, type: D7, for pin inserts

Additional products

Contact insert - HC-Q04-I-CT-F - 1419899



Contact insert, number of positions: 4, size: D7, number of connections per position: 1, Socket, Crimp connection, 830 V, 40 A, 1.5 mm² ... 6 mm², application: Power, Only suitable for plastic housings

Phoenix Contact 2020 © - all rights reserved
<http://www.phoenixcontact.com>

PHOENIX CONTACT GmbH & Co. KG
Flachsmarktstr. 8
32825 Blomberg
Germany
Tel. +49 5235 300
Fax +49 5235 3 41200
<http://www.phoenixcontact.com>

X-ON Electronics

Largest Supplier of Electrical and Electronic Components

Click to view similar products for [Heavy Duty Power Connectors](#) category:

Click to view products by [Phoenix Contact](#) manufacturer:

Other Similar products are found below :

[647757-1](#) [6643411-1](#) [6646058-2](#) [6646137-1](#) [6646138-1](#) [6646479-1](#) [6646608-1](#) [6646786-1](#) [6646940-1](#) [6651091-1](#) [6651525-1](#) [6651529-1](#)
[6651788-1](#) [696475-1](#) [702-32-01109](#) [703-25-02205](#) [73000005059](#) [73000005642](#) [73080965046](#) [765-15-0080A](#) [765-16-0080B](#) [765-18-0080D](#)
[829992-1](#) [902-77-02113](#) [PS00/A0620/6300](#) [129-1J](#) [1409400](#) [AN0024023](#) [E6374G1](#) [e6389g2](#) [157-43GW8](#) [MS3117-14AC](#) [1643543-1](#)
[1650540-1](#) [1651811-2](#) [1766260-1](#) [1766282-1](#) [1766966-1](#) [1791340000](#) [NLDFT-3-BL-L-S120-M40A](#) [NLDFT-N-W-L-C240-M40B](#) [NLS-2-R-](#)
[C240-M40B](#) [NLS-N-W-C240-M40B](#) [NPS-3-BL-T6](#) [1986615-1](#) [2-1589900-8](#) [2199314-1](#) [KA8102](#) [9300480317](#) [SBS50BRN#6](#)