

# Network cable - NBC-M8MSD/10,0-93C/R4AC - 1423714

Please be informed that the data shown in this PDF Document is generated from our Online Catalog. Please find the complete data in the user's documentation. Our General Terms of Use for Downloads are valid (<http://phoenixcontact.com/download>)



Network cable, PROFINET CAT5 (100 Mbps), EtherCAT® CAT5 (100 Mbps), 4-position, PUR/FRNC halogen-free, green RAL 6018, shielded (Advanced Shielding Technology), Plug straight M8 / IP67, coding: D, on Plug straight RJ45 / IP20, cable length: 10 m



## Key Commercial Data

Packing unit	1 pc
GTIN	 4 0 5 5 6 2 6 5 6 9 2 7 7
GTIN	4055626569277

## Technical data

### Dimensions

Length of cable	10 m
-----------------	------

### Ambient conditions

Degree of protection	IP65 (M12 connector)
	IP67 (M12 connector)
	IP20 (RJ45 connector)
Ambient temperature (operation)	-25 °C ... 90 °C (M12 connector)
	-25 °C ... 80 °C (RJ45 connector)

### General data

Note	This product corresponds to the PROFINET Cabling and Interconnection Technology Guideline for PROFINET regulations, version 2.00, order no: 2.252, Chapter 8.2 Connectors for Outside Environment (Balanced cabling)
Rated current at 40°C	1 A
Rated voltage	48 V AC
	60 V DC
Number of positions	4
Signal type/category	PROFINET CAT5 (IEC 11801), 100 Mbps

# Network cable - NBC-M8MSD/10,0-93C/R4AC - 1423714

## Technical data

### General data

	EtherCAT® CAT5 (IEC 11801), 100 Mbps
Standards/regulations	M8 connector IEC 61076-2-114
Transmission characteristics (category)	CAT5

### Characteristics head 1

Head type	Plug straight M8 / IP67
No. of positions (pin connector pattern)	4
Coding	D (Data)
Color	black
Material (component)	CuSn (Contact)
	Ni/Au (Contact surface)
	PA 6.6 (Contact carriers)
	TPU, hardly inflammable, self-extinguishing (Grip)
	Brass, nickel-plated (Screw connection)
Shielded	yes
Insulation resistance	≥ 100 MΩ
Insertion/withdrawal cycles	≥ 100
Torque	0.2 Nm
Ambient temperature (operation)	-25 °C ... 90 °C
Shielded	yes
Outer sheath, material	PUR
External sheath, color	green RAL 6018
Type type, plug side	Plug straight
Type type, socket side	Plug, straight

### Characteristics head 2

Head type	Plug straight RJ45 / IP20
No. of positions (pin connector pattern)	4 (8)
Color	black
Material (component)	CuSn (Contact)
	Ni/Au (Contact surface)
	PA (Contact carriers)
	PA (Housing)
Insertion/withdrawal cycles	≥ 750
Ambient temperature (operation)	-25 °C ... 80 °C

### Standards and Regulations

Standards/specifications	M8 connector IEC 61076-2-114
--------------------------	------------------------------

### Cable

Product labeling	"sequential length in metres" PN-CABLE-934-C / PUR-4X22AWG/7 Trailing * 22AWG (SHIELDED) (UL) E119100 CMX 75°C VERIFIED (UL) CAT 5E PATCH CABLE FRNC * (Cable printing cable supplier)
------------------	--

## Network cable - NBC-M8MSD/10,0-93C/R4AC - 1423714

### Technical data

#### Cable

Cable type	PROFINET drag chain CAT5
Cable type (abbreviation)	93C
Signal type/category	PROFINET CAT5 (IEC 11801), 100 Mbps
	EtherCAT® CAT5 (IEC 11801), 100 Mbps
Cable structure	1x4xAWG22/7; SF/TQ
Conductor cross section	4x 0.34 mm <sup>2</sup>
AWG signal line	22
Conductor structure signal line	7x 0.25 mm
Core diameter including insulation	1.5 mm
Wire colors	White, yellow, blue, orange
Overall twist	Star quad
Shielding	Aluminum-coated foil, tinned copper braided shield
Optical shield covering	85 %
External sheath, color	green RAL 6018
Outer sheath thickness	approx. 0.9 mm
External cable diameter D	6.5 mm ±0.2 mm
Minimum bending radius, fixed installation	5 x D
Minimum bending radius, flexible installation	7.5 x D
Number of bending cycles	3000000
Bending radius	100 mm
Traversing path	10 m
Traversing rate	4 m/s
Acceleration	4 m/s <sup>2</sup>
Torsion force	± 30 °/m
Tensile strength GRP	≤ 150 N
Cable weight	61 kg/km
Outer sheath, material	PUR
Material, inner sheath	FRNC
Material conductor insulation	PE
Conductor material	Tin-plated Cu litz wires
Insulation resistance	≥ 500 MΩ*km
Loop resistance	≤ 120.00 Ω/km
Wave impedance	100 Ω ±15 Ω (at 1 ... 100 MHz)
Near end crosstalk attenuation (NEXT)	80 dB (with 1 MHz)
	76 dB (at 4 MHz)
	70 dB (at 10 MHz)
	65 dB (at 16 MHz)
	63 dB (at 20 MHz)
	60 dB (at 31.25 MHz)
	55 dB (at 62.5 MHz)

## Network cable - NBC-M8MSD/10,0-93C/R4AC - 1423714

### Technical data

#### Cable

	50 dB (at 100 MHz)
Attenuation	2.1 dB (with 1 MHz)
	4 dB (at 4 MHz)
	6.3 dB (at 10 MHz)
	8 dB (at 16 MHz)
	9 dB (at 20 MHz)
	11.4 dB (at 31.25 MHz)
	16.5 dB (at 62.5 MHz)
	21.3 dB (at 100 MHz)
Signal speed	0.66 c
Signal runtime	5.3 ns/m
Coupling resistance	≤ 20.00 mΩ/m (at 10 MHz)
Nominal voltage, cable	600 V (UL rating)
Test voltage Core/Core	2000 V (50 Hz, 1 min.)
Test voltage Core/Shield	2000 V (50 Hz, 1 min.)
Special properties	Electrical properties according to EN 50288-2-2
Flame resistance	according to IEC 60332-1-2
Halogen-free	yes
Resistance to oil	in accordance with DIN EN 60811-2-1
Other resistance	UV resistant
Ambient temperature (operation)	-40 °C ... 70 °C (cable, fixed installation)
	-40 °C ... 70 °C (cable, flexible installation)
Ambient temperature (installation)	-20 °C ... 60 °C
Ambient temperature (storage/transport)	-50 °C ... 70 °C

#### Environmental Product Compliance

REACH SVHC	Lead 7439-92-1
China RoHS	Environmentally Friendly Use Period = 50 years
	For details about hazardous substances go to tab "Downloads", Category "Manufacturer's declaration"

#### Drawings

# Network cable - NBC-M8MSD/10,0-93C/R4AC - 1423714

Schematic diagram

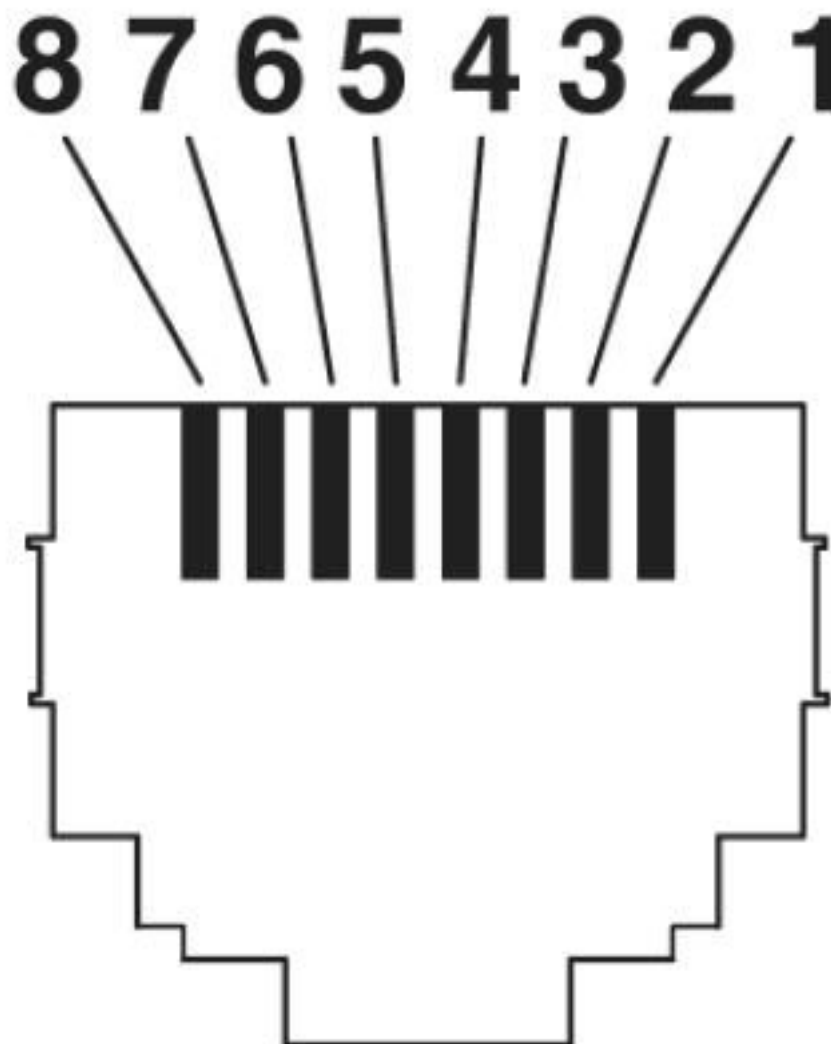

Connector pin assignment plug RJ45

# Network cable - NBC-M8MSD/10,0-93C/R4AC - 1423714

Schematic diagram

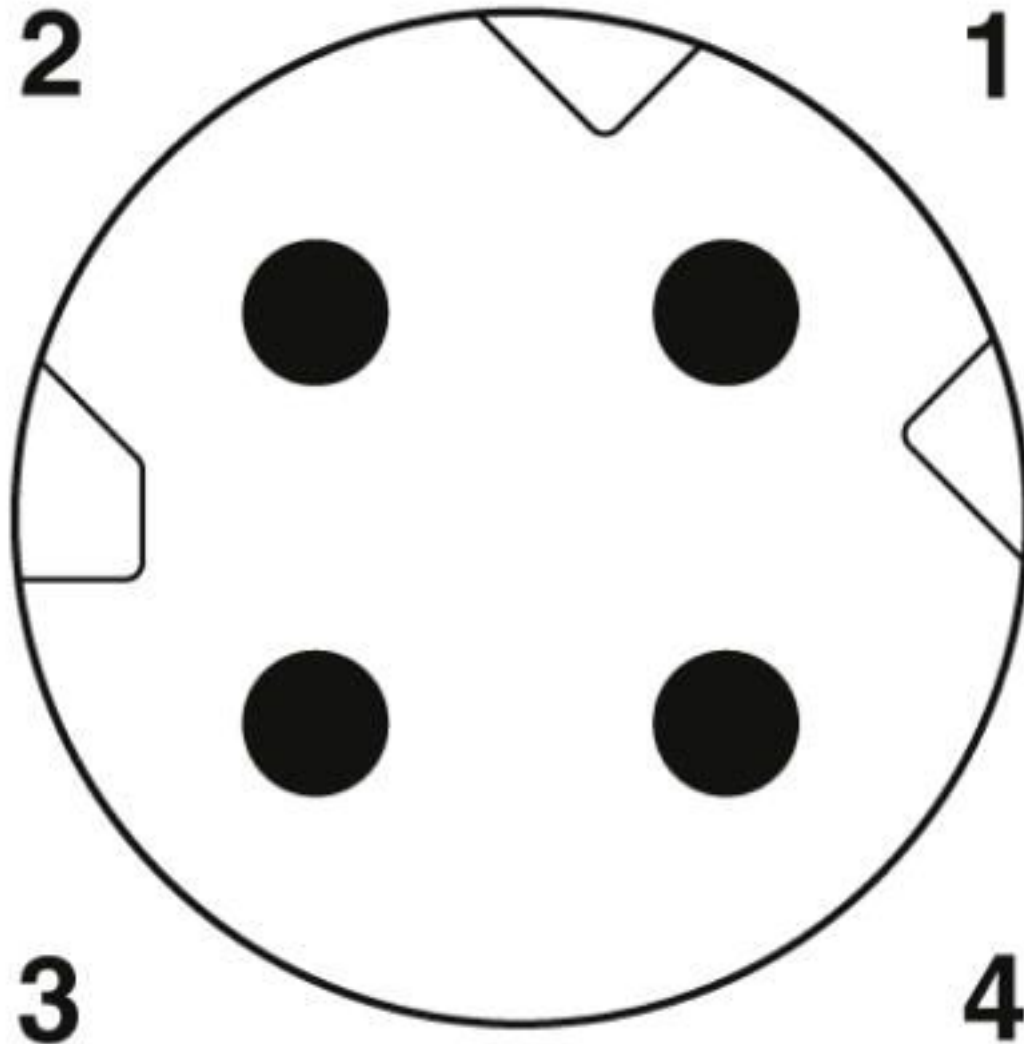

Pin assignment M8 male connector, 4-pos., D-coded, view of pin side

# Network cable - NBC-M8MSD/10,0-93C/R4AC - 1423714

Dimensional drawing

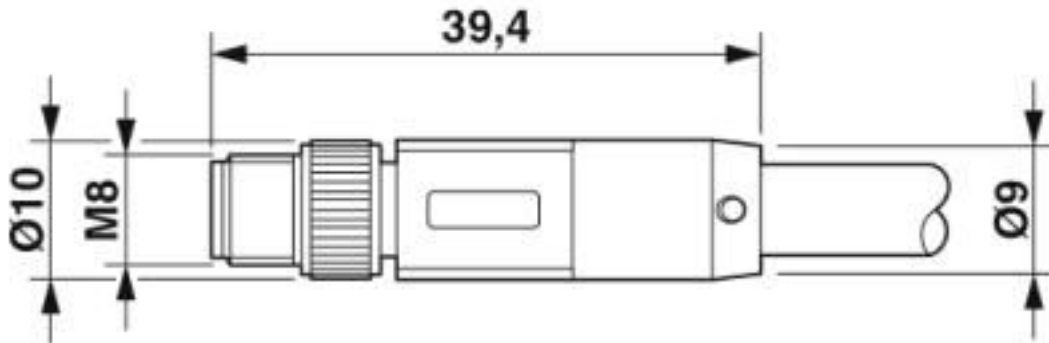

Plug M8 x 1, straight, shielded

Dimensional drawing

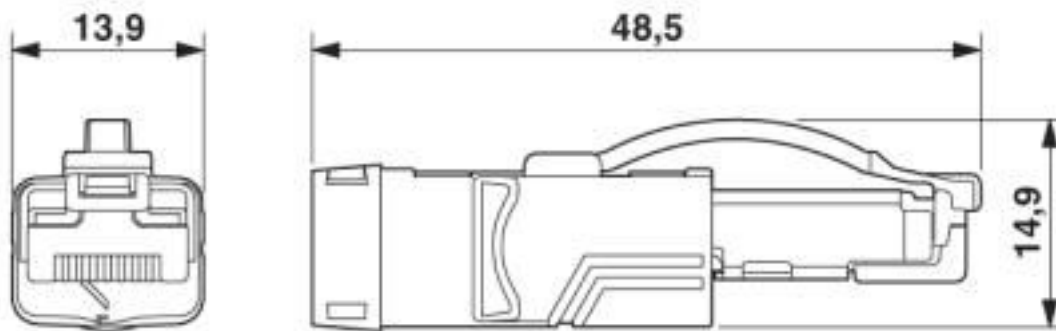

RJ45 connector, IP20

Circuit diagram

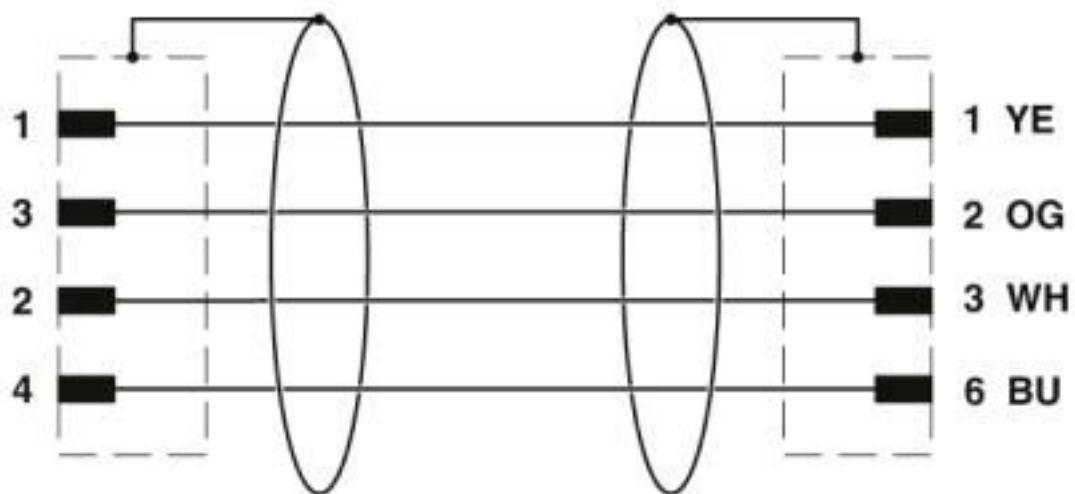

Contact assignment of the M8 and RJ45 plug

# Network cable - NBC-M8MSD/10,0-93C/R4AC - 1423714

Cable cross section



PROFINET drag chain CAT5 [93C]

## Classifications

eCl@ss

eCl@ss 10.0.1	27060308
eCl@ss 7.0	27060308
eCl@ss 8.0	27060308
eCl@ss 9.0	27060308

ETIM

ETIM 5.0	EC002599
ETIM 6.0	EC001262
ETIM 7.0	EC001262



## Network cable - NBC-M8MSD/10,0-93C/R4AC - 1423714

### Approvals

Approvals

---

Approvals

EAC-RoHS / EAC

---

Ex Approvals

---

### Approval details

EAC-RoHS		RU D- DE.HB35.B.00385
----------	---	--------------------------

EAC		RU C- DE.BL08.B.00286
-----	--	--------------------------

---

Phoenix Contact 2020 © - all rights reserved  
<http://www.phoenixcontact.com>

PHOENIX CONTACT GmbH & Co. KG  
Flachsmarktstr. 8  
32825 Blomberg  
Germany  
Tel. +49 5235 300  
Fax +49 5235 3 41200  
<http://www.phoenixcontact.com>

## X-ON Electronics

Largest Supplier of Electrical and Electronic Components

*Click to view similar products for [Ethernet Cables / Networking Cables](#) category:*

*Click to view products by [Phoenix Contact](#) manufacturer:*

Other Similar products are found below :

[73-6670-7](#) [73-6680-15](#) [73-7797-25](#) [MCJB2-10P6Q7-120](#) [84909-0204](#) [1200700174](#) [1200860368](#) [E16A06002M030](#) [E200102-009-S1](#)  
[AX105346-EW](#) [MT14-187L](#) [17-103530](#) [ERWPAB3002M005](#) [190-038045-01](#) [NK5EPC18RDY](#) [NK5EPC18VLY](#) [NK5EPC18YLY](#)  
[NK5EPC1GRY](#) [NK5EPC4Y](#) [NK5EPC6YLY](#) [NK5EPC8BLY](#) [NK5EPC9YLY](#) [1969343-6](#) [C501100010](#) [C501106002](#) [C501106007](#)  
[C501106015](#) [C501106025](#) [C601102010](#) [C601104010](#) [C601106007](#) [C601106015](#) [2142758-2](#) [2168427-2](#) [CAT1106007](#) [21949-1](#) [2J1866A](#)  
[RJF SFTP 5E 0500](#) [AX100351](#) [MN14CEC/ST](#) [C501100015](#) [C501106004](#) [C501106010](#) [C5F1108007](#) [C601104004](#) [C601106004](#)  
[CA21106004](#) [CA21106010](#) [CA21106015](#) [CA21109007](#)