

## Power cable - SAC-4P-M12MRS/ 1,5-PUR PE SH - 1424108

Please be informed that the data shown in this PDF Document is generated from our Online Catalog. Please find the complete data in the user's documentation. Our General Terms of Use for Downloads are valid (<http://phoenixcontact.com/download>)



Power cable, 4-position, PUR halogen-free, orange RAL 2003, shielded (Advanced Shielding Technology), Plug angled M12, coding: S, on free cable end, cable length: 1.5 m, for AC current up to 12 A/690 V

### Your advantages

- ✓ Easy and safe: 100% electrically tested plug-in components
- ✓ High-performance: AC connectors for up to 12 A and 690 V AC
- ✓ Protection against incorrect connection using special S-coding
- ✓ Our standard: robust halogen-free PUR cable
- ✓ Shield power reliably – 360° shielding to reduce electromagnetic loads

### Key Commercial Data

Packing unit	1 pc
GTIN	 4 046356 693127
GTIN	4046356693127

### Technical data

#### Dimensions

Length of cable	1.5 m
-----------------	-------

#### Ambient conditions

Ambient temperature (operation)	-25 °C ... 85 °C (Plug / socket)
Degree of protection	IP65
	IP67 (without preloading, as additional test in accordance with IEC 60529)

#### General

Rated current at 40°C	12 A
Rated voltage	690 V AC
Number of positions	4
Color handle area	black

# Power cable - SAC-4P-M12MRS/ 1,5-PUR PE SH - 1424108

## Technical data

### General

Insulation resistance	≥ 100 MΩ
Coding	S power
Standards/regulations	M12 connector IEC 61076-2-111
Status display	No
Protective circuit/component	unwired
Overvoltage category	III
Degree of pollution	3
Insertion/withdrawal cycles	> 100
Torque	0.4 Nm (M12 connector)

### Material

Flammability rating according to UL 94	V0
Contact material	CuZn
Contact surface material	Ni/Au
Contact carrier material	PA
Material of grip body	PP
Material, knurls	Zinc die-cast, nickel-plated

### Standards and Regulations

Standards/specifications	M12 connector IEC 61076-2-111
Flammability rating according to UL 94	V0

### Cable

Cable type	PUR halogen-free orange shielded
Cable type (abbreviation)	PUR
Cable abbreviation	9YSLC11Y-JZ
UL AWM style	20234 / 10492 (80°C/1000 V)
Conductor cross section	4x 1.5 mm <sup>2</sup>
AWG power supply	16
Conductor structure, voltage supply	78x 0.15 mm
Core diameter including insulation	≤ 2.5 mm
Thickness, insulation	0.4 mm
Wire colors	Black 1, black 2, black 3, green/yellow
Overall twist	4 wires optimally twisted
Shielding	Tinned copper-braided shield, approx. 85% covering
External sheath, color	orange RAL 2003
Outer sheath thickness	1.2 mm
External cable diameter D	9.7 mm ±0.3 mm
Minimum bending radius, fixed installation	5 x D
Minimum bending radius, flexible installation	7.5 x D
Number of bending cycles	4000000
Minimum bending radius, drag chain applications	10 x D

## Power cable - SAC-4P-M12MRS/ 1,5-PUR PE SH - 1424108

### Technical data

#### Cable

Traversing path	10 m
Traversing rate	3 m/s
Acceleration	10 m/s <sup>2</sup>
Torsion force	± 25 °/m
Outer sheath, material	PUR
Material conductor insulation	PP
Conductor material	Bare Cu litz wires
Insulation resistance	≥ 10 MΩ*km (at 20 °C)
Conductor resistance	≤ 13.3 Ω/km (at 20 °C)
Nominal voltage, cable	1000 V AC
Test voltage, cable	4260 V AC (5 min.)
Flame resistance	according to EN 60332-1-2
	in acc. to UL 1581 VW1
	According to CSA C 22.2 No. 210-05 FT1
Halogen-free	according to VDE 0282-13 Appendix C
Resistance to oil	in accordance with DIN EN 60811-2-1
	According to DIN EN 50363-10-2
Other resistance	UV resistant
	Low adhesion
Ambient temperature (operation)	-40 °C ... 90 °C (cable, fixed installation)
	-30 °C ... 90 °C (cable, flexible installation)

#### Environmental Product Compliance

REACH SVHC	Lead 7439-92-1
China RoHS	Environmentally Friendly Use Period = 50 years
	For details about hazardous substances go to tab "Downloads", Category "Manufacturer's declaration"

#### Drawings

# Power cable - SAC-4P-M12MRS/ 1,5-PUR PE SH - 1424108

Dimensional drawing

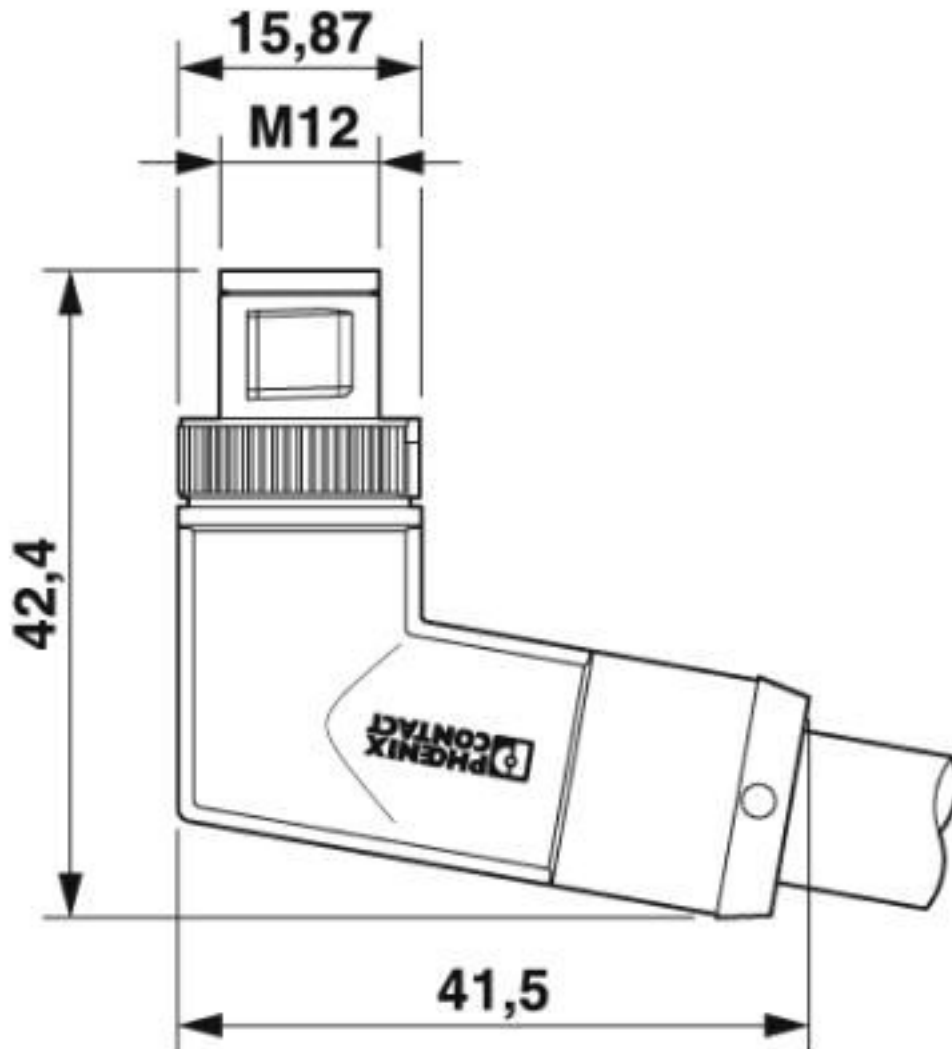

M12 x 1 male plug, angled

## Power cable - SAC-4P-M12MRS/ 1,5-PUR PE SH - 1424108

Schematic diagram

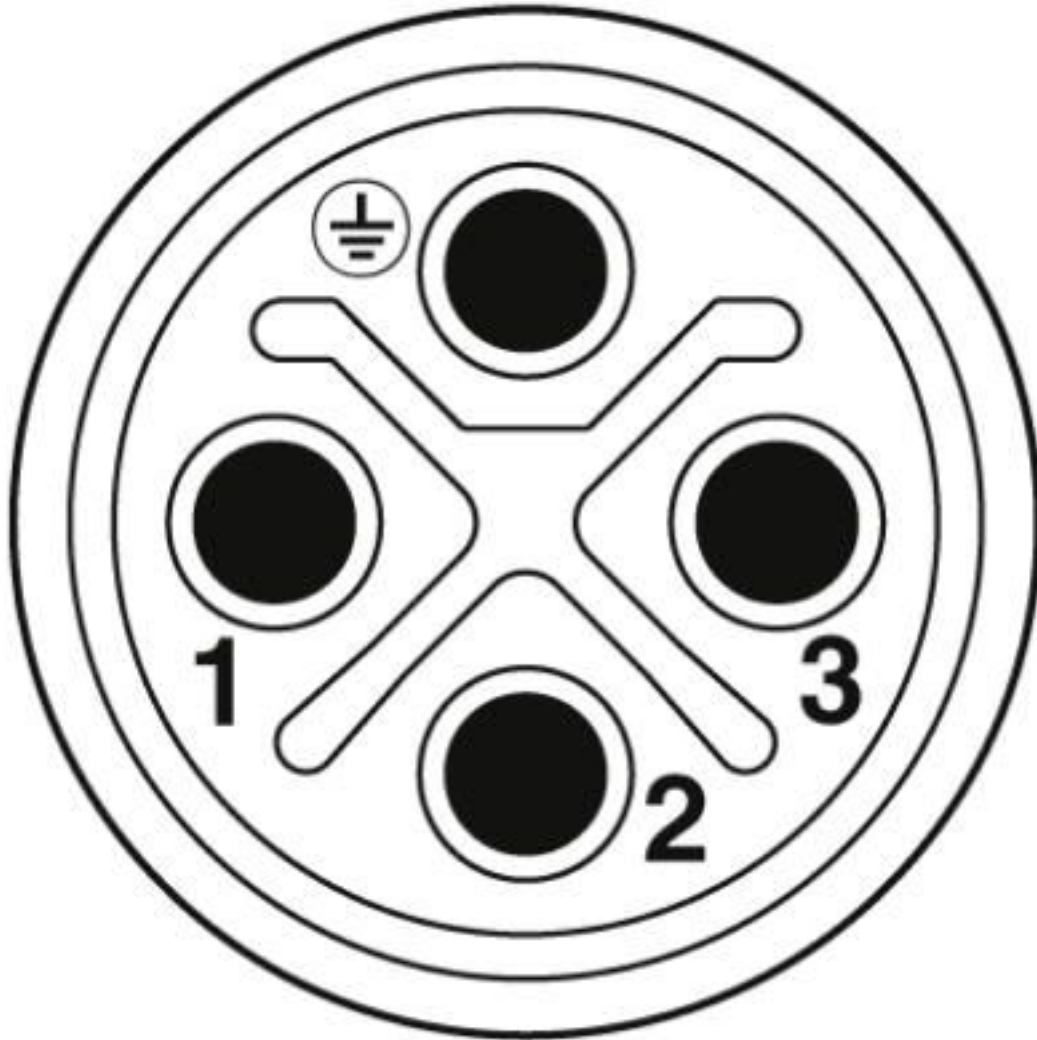

M12 plug pin assignment, 4-pos., S-coded, plug side view

# Power cable - SAC-4P-M12MRS/ 1,5-PUR PE SH - 1424108

Diagram

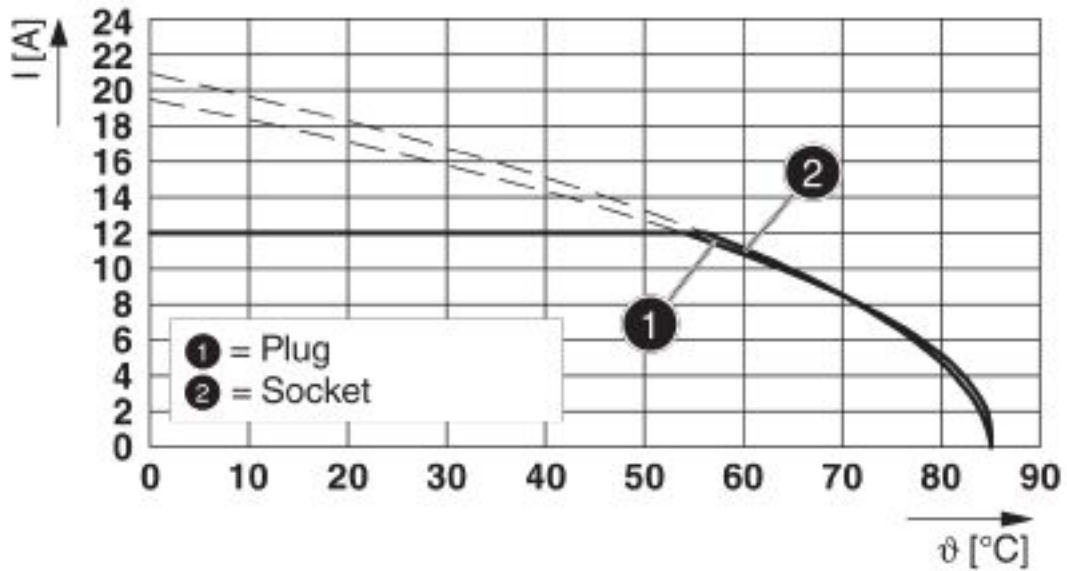

Current carrying capacity

Circuit diagram

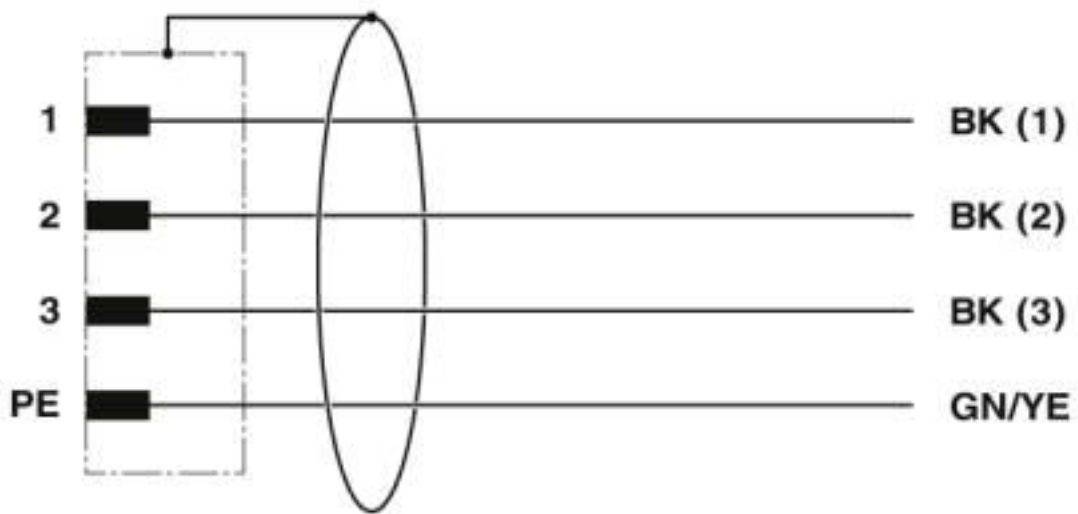

Contact assignment of the M12 plug

# Power cable - SAC-4P-M12MRS/ 1,5-PUR PE SH - 1424108

Cable cross section



PUR halogen-free orange shielded [PUR]

## Classifications

eCl@ss

eCl@ss 10.0.1	27060311
eCl@ss 4.0	27140800
eCl@ss 4.1	27140800
eCl@ss 5.0	27143400
eCl@ss 5.1	27143400
eCl@ss 6.0	27279200
eCl@ss 7.0	27279218
eCl@ss 8.0	27279218
eCl@ss 9.0	27060311

# Power cable - SAC-4P-M12MRS/ 1,5-PUR PE SH - 1424108

## Classifications

### ETIM

ETIM 3.0	EC002061
ETIM 4.0	EC001855
ETIM 5.0	EC001855
ETIM 6.0	EC001855
ETIM 7.0	EC001855

### UNSPSC

UNSPSC 6.01	31251501
UNSPSC 7.0901	31251501
UNSPSC 11	31251501
UNSPSC 12.01	31251501
UNSPSC 13.2	31251501
UNSPSC 19.0	31251501
UNSPSC 20.0	31251501
UNSPSC 21.0	31251501

## Approvals

### Approvals

#### Approvals

UL Listed / cUL Listed / EAC-RoHS / EAC / cULus Listed

#### Ex Approvals

### Approval details

UL Listed		<a href="http://database.ul.com/cgi-bin/XYV/template/LISEXT/1FRAME/index.htm">http://database.ul.com/cgi-bin/XYV/template/LISEXT/1FRAME/index.htm</a>	FILE E 468743
Nominal voltage UN	600 V		
Nominal current IN	12 A		
mm <sup>2</sup> /AWG/kcmil	16		

cUL Listed		<a href="http://database.ul.com/cgi-bin/XYV/template/LISEXT/1FRAME/index.htm">http://database.ul.com/cgi-bin/XYV/template/LISEXT/1FRAME/index.htm</a>	FILE E 468743
Nominal voltage UN	600 V		



# Power cable - SAC-4P-M12MRS/ 1,5-PUR PE SH - 1424108

## Approvals

Nominal current IN	12 A
mm <sup>2</sup> /AWG/kcmil	16

EAC-RoHS		RU D- DE.HB35.B.00387
----------	--	--------------------------

EAC		RU C- DE.BL08.B.00286
-----	--	--------------------------

cULus Listed		
--------------	--	--

## Accessories

### Accessories

#### Protective cap

Sealing cap - PROT-M12 FS - 1560251



M12 sealing cap for unoccupied M12 plugs of the sensor/actuator cable, flush-type plugs and I/O devices in the field

#### Screwdriver tools

Tool - SAC BIT M12-D16 - 1200305



Nut for assembling sensor/actuator cables with M12 connector and M12 connectors for assembly, knurl diameter: 16 mm, for 4 mm hexagonal drive

Phoenix Contact 2020 © - all rights reserved  
<http://www.phoenixcontact.com>

PHOENIX CONTACT GmbH & Co. KG  
Flachmarktstr. 8  
32825 Blomberg  
Germany  
Tel. +49 5235 300  
Fax +49 5235 3 41200  
<http://www.phoenixcontact.com>

## X-ON Electronics

Largest Supplier of Electrical and Electronic Components

*Click to view similar products for [Specialised Cables](#) category:*

*Click to view products by [Phoenix Contact](#) manufacturer:*

Other Similar products are found below :

[603PT6](#) [603SS6L](#) [604PT6](#) [604SS6](#) [706000D02F200](#) [910640](#) [1200740077](#) [1200740114](#) [AC172](#) [ACL-SSI-4](#) [R88ACAKA0015SRE](#)  
[R88ACAWL005SDE](#) [R88ACRGD0R3C](#) [1300150047](#) [1300660036](#) [1302262116](#) [1300150149](#) [1300220020](#) [1300220104](#) [1300220119](#)  
[1301240492](#) [1301810221](#) [1365323-1](#) [1613055](#) [176P12](#) [1971465-2](#) [20240400003](#) [20240400013](#) [2085828-1](#) [20886510030](#) [2-22733-8](#) [22733-](#)  
[8](#) [CB-5PSBC-RS](#) [CB-704EC-RS](#) [CB-BATACC-RS](#) [CB-JST3PSW-RS](#) [CB-M12COM-R10](#) [25AC84](#) [25AK84X](#) [25AU25](#) [25FN82](#) [3011-03](#)  
[AC118](#) [ACL-HHS-1M\(CAT5E\)](#) [SSL009PC2DC012N](#) [FC2A-KC6C](#) [2085828-2](#) [20886510150](#) [CCS-FCB-5](#) [CCSFCBF2](#)