

Power cable - SAC-4P-M12MRT/ 3,0-PUR SH - 1424125

Please be informed that the data shown in this PDF Document is generated from our Online Catalog. Please find the complete data in the user's documentation. Our General Terms of Use for Downloads are valid (<http://phoenixcontact.com/download>)



Power cable, 4-position, PUR halogen-free, black RAL 9005, shielded (Advanced Shielding Technology), Plug angled M12, coding: T, on free cable end, cable length: 3 m, For direct current up to 12 A/63 V

Your advantages

- ✓ Easy and safe: 100% electrically tested plug-in components
- ✓ High-performance: DC connectors for up to 12 A and 63 V DC
- ✓ Protection against incorrect connection using special T-coding
- ✓ Shield power reliably – 360° shielding to reduce electromagnetic loads
- ✓ Our standard: robust halogen-free PUR cable

Key Commercial Data

Packing unit	1 pc
GTIN	 4 046356 693295
GTIN	4046356693295

Technical data

Dimensions

Length of cable	3 m
-----------------	-----

Ambient conditions

Ambient temperature (operation)	-25 °C ... 85 °C (Plug / socket)
Degree of protection	IP65
	IP67

General

Rated current at 40°C	12 A
Rated voltage	63 V DC
Number of positions	4
Color handle area	black
Insulation resistance	≥ 100 MΩ

Power cable - SAC-4P-M12MRT/ 3,0-PUR SH - 1424125

Technical data

General

Coding	T power
Standards/regulations	M12 connector IEC 61076-2-111
Status display	No
Protective circuit/component	unwired
Overvoltage category	III
Degree of pollution	3
Insertion/withdrawal cycles	> 100
Torque	0.4 Nm (M12 connector)

Material

Flammability rating according to UL 94	V0
Contact material	CuZn
Contact surface material	Ni/Au
Contact carrier material	PA
Material of grip body	PP
Material, knurls	Zinc die-cast, nickel-plated

Standards and Regulations

Standards/specifications	M12 connector IEC 61076-2-111
Flammability rating according to UL 94	V0

Cable

Cable type	PUR halogen-free black
Cable type (abbreviation)	PUR
Cable abbreviation	LS9YC11Y-OB
Conductor cross section	4x 1.5 mm ²
AWG power supply	16
Core diameter including insulation	2.4 mm
Thickness, insulation	1.2 mm (Outer cable sheath)
Wire colors	brown, white, blue, black
Overall twist	4 wires optimally twisted
Shielding	Tinned copper-braided shield, approx. 85% covering
External sheath, color	black RAL 9005
External cable diameter D	9.7 mm ±0.3 mm
Smallest bending radius, fixed installation	49 mm
Smallest bending radius, movable installation	73 mm
Number of bending cycles	4000000
Bending radius	97 mm
Traversing path	10 m
Traversing rate	3 m/s
Acceleration	10 m/s ²
Torsion force	± 25 °/m

Power cable - SAC-4P-M12MRT/ 3,0-PUR SH - 1424125

Technical data

Cable

Cable weight	133 kg/km
Outer sheath, material	PUR
Material conductor insulation	PP
Conductor material	Bare Cu litz wires
Insulation resistance	$\geq 10 \text{ M}\Omega \cdot \text{km}$ (at 20 °C)
Conductor resistance	$\leq 13.3 \text{ }\Omega/\text{km}$ (at 20 °C)
Nominal voltage, cable	300 V AC
Test voltage, cable	1500 V AC (5 min.)
Flame resistance	according to EN 60332-1-2
	in acc. to UL 1581 VW1
Halogen-free	in accordance with DIN VDE 0472 part 815
	according to IEC 60754-1
Resistance to oil	in accordance with DIN EN 60811-2-1
	According to DIN EN 50363-10-2
Ambient temperature (operation)	-40 °C ... 90 °C (cable, fixed installation)
	-30 °C ... 90 °C (cable, flexible installation)

Environmental Product Compliance

REACH SVHC	Lead 7439-92-1
China RoHS	Environmentally friendly use period: unlimited = EFUP-e
	No hazardous substances above threshold values

Drawings

Power cable - SAC-4P-M12MRT/ 3,0-PUR SH - 1424125

Dimensional drawing

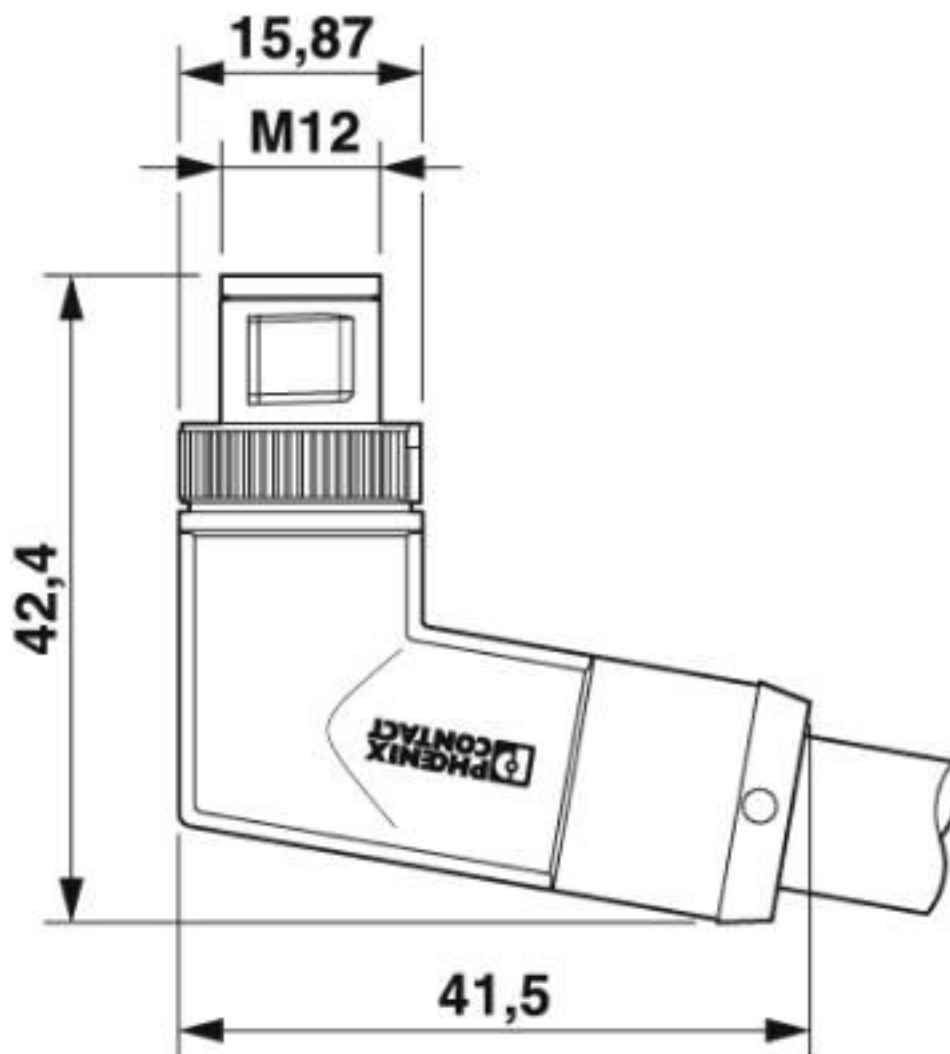

M12 x 1 male plug, angled

Power cable - SAC-4P-M12MRT/ 3,0-PUR SH - 1424125

Diagram

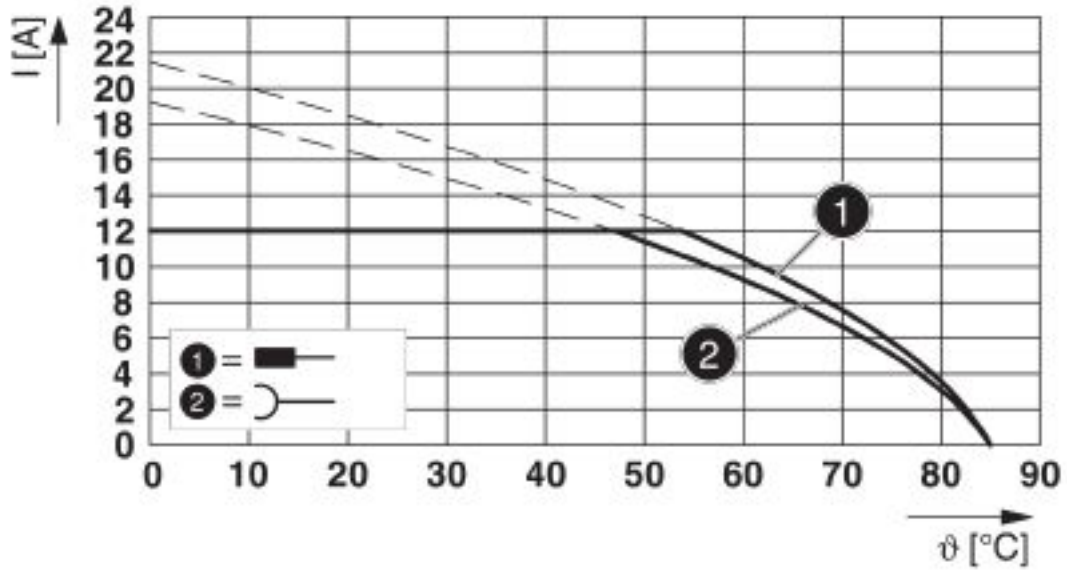

Current carrying capacity

Circuit diagram

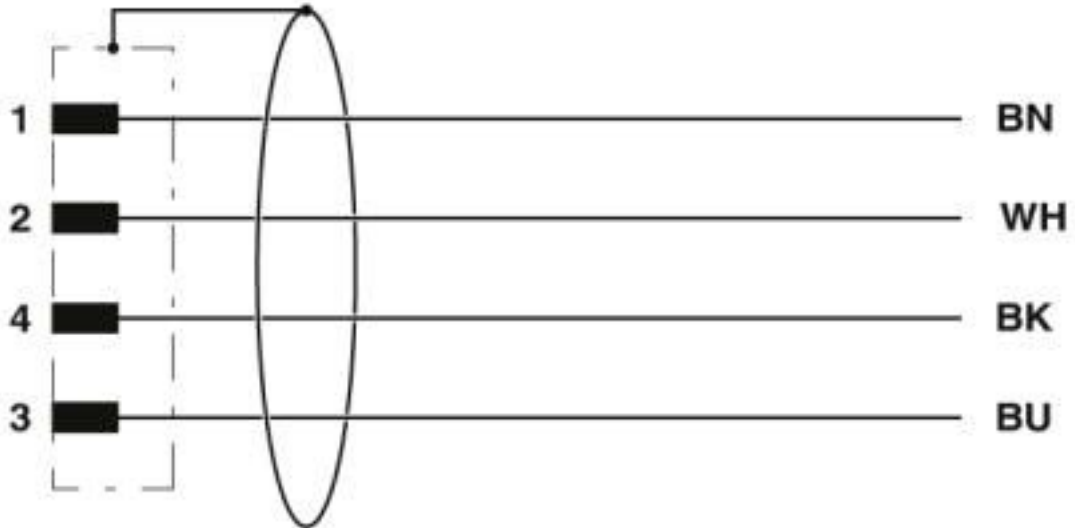

Contact assignment of the M12 plug

Power cable - SAC-4P-M12MRT/ 3,0-PUR SH - 1424125

Schematic diagram

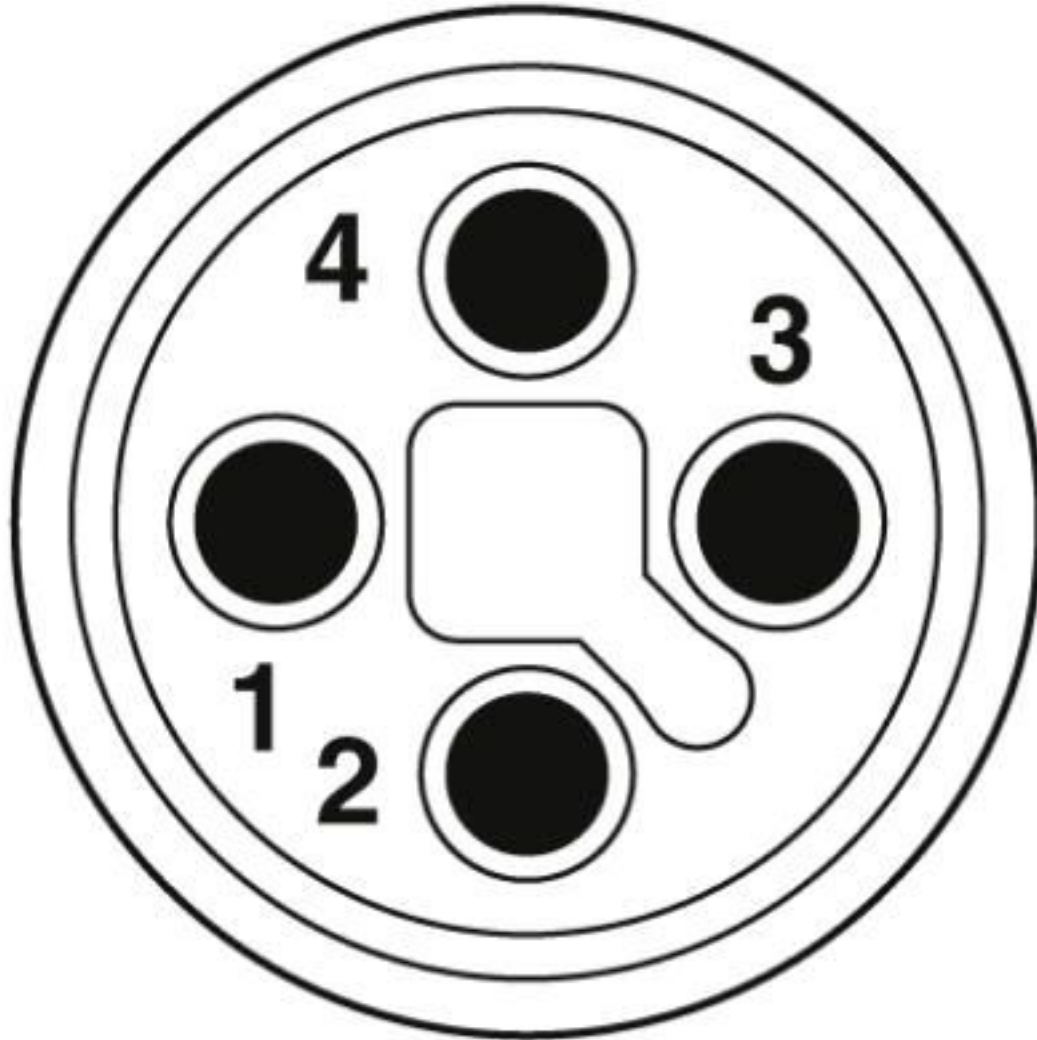

Pin assignment for M12 plug, 4-pos., T-coded, view of plug side

Power cable - SAC-4P-M12MRT/ 3,0-PUR SH - 1424125

Cable cross section

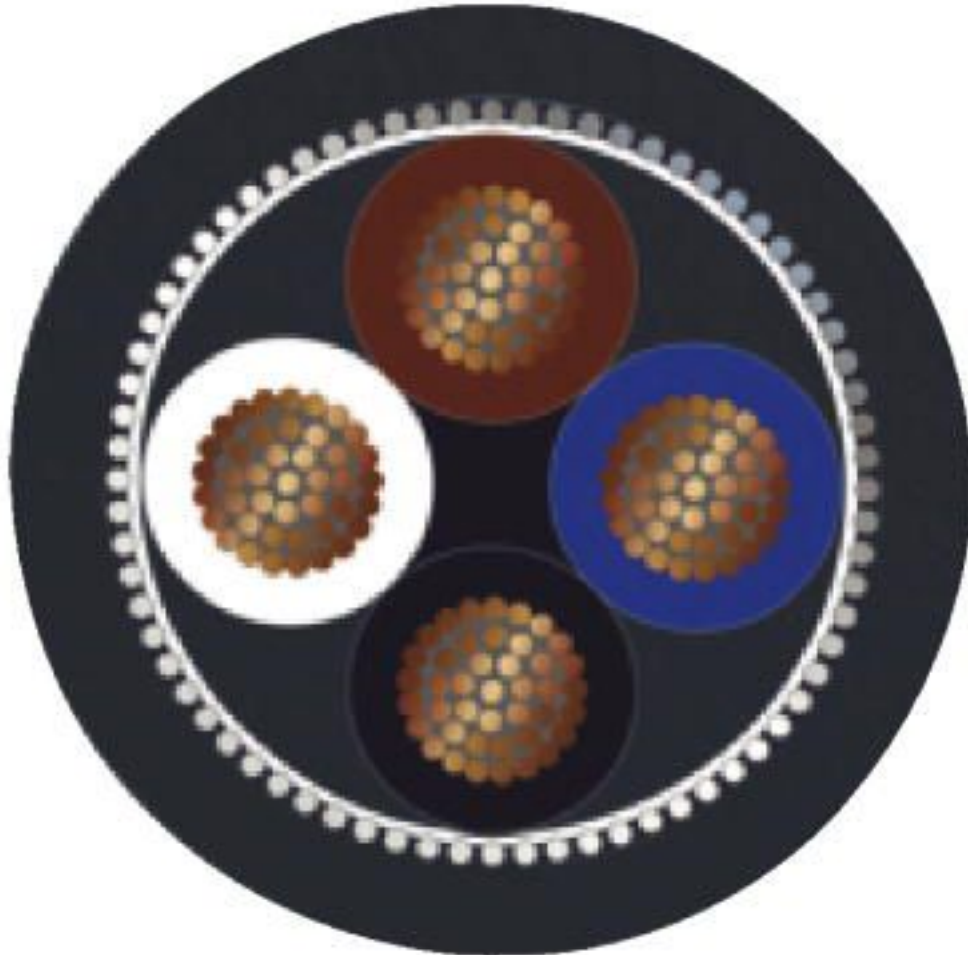

PUR halogen-free black [PUR]

Classifications

eCl@ss

eCl@ss 10.0.1	27060311
eCl@ss 4.0	27140800
eCl@ss 4.1	27140800
eCl@ss 5.0	27143400
eCl@ss 5.1	27143400
eCl@ss 6.0	27279200
eCl@ss 7.0	27279218
eCl@ss 8.0	27279218
eCl@ss 9.0	27060311

Power cable - SAC-4P-M12MRT/ 3,0-PUR SH - 1424125

Classifications

ETIM

ETIM 3.0	EC002061
ETIM 4.0	EC001855
ETIM 5.0	EC001855
ETIM 6.0	EC001855
ETIM 7.0	EC001855

UNSPSC

UNSPSC 6.01	31251501
UNSPSC 7.0901	31251501
UNSPSC 11	31251501
UNSPSC 12.01	31251501
UNSPSC 13.2	31251501
UNSPSC 19.0	31251501
UNSPSC 20.0	31251501
UNSPSC 21.0	31251501

Approvals

Approvals

Approvals

UL Listed / cUL Listed / EAC-RoHS / cULus Listed

Ex Approvals

Approval details

UL Listed		http://database.ul.com/cgi-bin/XYV/template/LISEXT/1FRAME/index.htm	E468743
Nominal voltage UN	63 V		
Nominal current IN	12 A		
mm ² /AWG/kcmil	16		

cUL Listed		http://database.ul.com/cgi-bin/XYV/template/LISEXT/1FRAME/index.htm	E468743
Nominal voltage UN	63 V		

Power cable - SAC-4P-M12MRT/ 3,0-PUR SH - 1424125

Approvals

Nominal current IN	12 A
mm ² /AWG/kcmil	16

EAC-RoHS		RU D- DE.HB35.B.00387
----------	--	--------------------------

cULus Listed		
--------------	--	--

Accessories

Accessories

Protective cap

Sealing cap - PROT-M12 FS - 1560251



M12 sealing cap for unoccupied M12 plugs of the sensor/actuator cable, flush-type plugs and I/O devices in the field

Screwdriver tools

Tool - SAC BIT M12-D16 - 1200305



Nut for assembling sensor/actuator cables with M12 connector and M12 connectors for assembly, knurl diameter: 16 mm, for 4 mm hexagonal drive

Phoenix Contact 2020 © - all rights reserved
<http://www.phoenixcontact.com>

PHOENIX CONTACT GmbH & Co. KG
Flachsmarktstr. 8
32825 Blomberg
Germany
Tel. +49 5235 300
Fax +49 5235 3 41200
<http://www.phoenixcontact.com>

X-ON Electronics

Largest Supplier of Electrical and Electronic Components

Click to view similar products for [Sensor Cables / Actuator Cables](#) category:

Click to view products by [Phoenix Contact](#) manufacturer:

Other Similar products are found below :

[60963](#) [60964](#) [703000D02F2002](#) [703001D02F0602](#) [703001D02F300](#) [704000D02F120](#) [773032K02F030](#) [802027107404-1](#) [802027213811-1](#)
[804001A09M150](#) [805001A09M0502](#) [84914-0235](#) [84914-0237](#) [885030A09M020](#) [8R4J30E03C3003](#) [1200651332](#) [1200651713](#) [1200660844](#)
[1200660845](#) [1200661173](#) [1200680071](#) [1200720053](#) [1200720081](#) [1200720099](#) [1200720217](#) [1200800231](#) [1200860125](#) [1200870123](#)
[1200980102](#) [1200650267](#) [1200650298](#) [1200660183](#) [1200660782](#) [1200660849](#) [1200661295](#) [1200661297](#) [1200661342](#) [1200661343](#)
[1200670080](#) [1200670220](#) [1200680331](#) [1200720252](#) [1200730184](#) [1200860344](#) [1200870359](#) [1200870643](#) [1200980008](#) [1200980031](#)
[1210502211](#) [1210400542](#)