

Bus system flush-type socket - VS-FSBPXS-OE-94F/2,0 - 1424151

Please be informed that the data shown in this PDF Document is generated from our Online Catalog. Please find the complete data in the user's documentation. Our General Terms of Use for Downloads are valid (<http://phoenixcontact.com/download>)



Assembled Ethernet cable, CAT6_A, shielded, 4-pair, 26 AWG stranded (7-wire), RAL 5021 (water blue), M12 flush-type socket, rear/screw mounting with M16 thread to free cable end, length: 2 m

Your advantages

- ✓ Pre-assembled with cables in various standard lengths for immediate use
- ✓ Customer-specific assemblies and cable lengths can be supplied
- ✓ Sealed on the cable side for optimum tightness of seal
- ✓ Cable designs for all common networks and fieldbuses
- ✓ For high transmission safety: shield connection to the housing with optional EMC nut



Key Commercial Data

Packing unit	1 pc
GTIN	
GTIN	4046356692632

Technical data

Dimensions

Length of cable	2 m
-----------------	-----

Ambient conditions

Degree of protection	IP65
	IP67
Ambient temperature (operation)	-25 °C ... 85 °C (Plug / socket)
	-40 °C ... 85 °C (without mechanical actuation)

General data

Note	The electrical and mechanical data specified assume that the connector pair is correctly locked and mounted. If the connector is unlocked and if there is a danger of contamination, the connector must be sealed using a protective cap > IP54. Influences arising from litz wires, cables or PCB assembly must also be taken into consideration.
------	--

Bus system flush-type socket - VS-FSBPXS-OE-94F/2,0 - 1424151

Technical data

General data

Rated current at 40°C	0.5 A (Plug/socket in accordance with IEC 61076-2-101, cable technical data is to be observed)
Rated voltage	50 V AC
	60 V DC
Rated surge voltage	0.8 kV
Number of positions	8
Signal type/category	Ethernet CAT6 _A , 10 Gbps
Standards/regulations	M12 connector IEC 61076-2-109
Overvoltage category	III
Degree of pollution	3
Alternative short product description	Ethernet cable
Contact material	CuZn
Contact carrier material	PPA
Contact surface material	Au
Degree of protection	IP65/IP67
Transmission characteristics (category)	CAT6 _A

Characteristics head 1

Shielded	yes
Outer sheath, material	PUR
External sheath, color	water blue RAL 5021
Type type, plug side	Flush-type socket, straight
Type type, socket side	free cable end

Standards and Regulations

Standards/specifications	M12 connector IEC 61076-2-109
Flammability rating according to UL 94	V0
Safety note	WARNING: The connectors may not be plugged in or disconnected under load. Ignoring the warning or improper use may damage persons and/or property.
	• WARNING: Commission properly functioning products only. The products must be regularly inspected for damage. Decommission defective products immediately. Replace damaged products. Repairs are not possible.
	• WARNING: Only electrically qualified personnel may install and operate the product. They must observe the following safety notes. The qualified personnel must be familiar with the basics of electrical engineering. They must be able to recognize and prevent danger. The relevant symbol on the packaging indicates that only personnel familiar with electrical engineering are allowed to install and operate the product.
	• The products are suitable for applications in plant, controller, and electrical device engineering.
	• When operating the connectors in outdoor applications, they must be separately protected against environmental influences.
	• Assembled products may not be manipulated or improperly opened.

Bus system flush-type socket - VS-FSBPXS-OE-94F/2,0 - 1424151

Technical data

Standards and Regulations

	<ul style="list-style-type: none"> • Only use mating connectors that are specified in the technical data of the standards listed (e.g. the ones listed in the product accessories online at phoenixcontact.com/products).
	<ul style="list-style-type: none"> • When using the product in direct connection with third-party manufacturers, the user is responsible.
	<ul style="list-style-type: none"> • For operating voltages > 50 V AC, conductive connector housings must be grounded
	<ul style="list-style-type: none"> • Ensure that when laying the cable, the tensile load on the connectors does not exceed the upper limit specified in the standards.
	<ul style="list-style-type: none"> • Observe the corresponding technical data. You will find information: <ul style="list-style-type: none"> o On the product o On the packing label o In the supplied documentation o Online at phoenixcontact.com/products under the product
	<ul style="list-style-type: none"> • Only use tools recommended by Phoenix Contact
	<ul style="list-style-type: none"> • Use a protective cap to protect connectors that are not in use. The suitable accessories are available online in the accessory section of the product at phoenixcontact.com/products
	<ul style="list-style-type: none"> • Ensure that the protective or functional ground has been properly connected.
	<ul style="list-style-type: none"> • VDE 0100/1.97 § 411.1.3.2 and DIN EN 60 204/11.98 § 14.1.3 are applicable when combining several circuits in a cable and/or connector
	<ul style="list-style-type: none"> • The connector warms up in normal operation. Depending on the ambient conditions, the surface of the connector can continue to warm up. In this case, the user is responsible for posting warnings (e.g. DIN EN ISO 13732-1:2008-12).

Cable

Cable type	Ethernet 10 Gbit
Cable type (abbreviation)	94F
UL AWM style	20963 (80°C/30 V)
Signal type/category	Ethernet CAT6 _A , 10 Gbps
Cable structure	4x2xAWG26/7; S/FTP
Conductor cross section	4x 2x 0.14 mm ²
AWG signal line	26
Conductor structure signal line	7x 0.16 mm
Core diameter including insulation	1.04 mm
Wire colors	white/blue-blue, white/orange-orange, white/green-green, white/brown-brown
Twisted pairs	2 cores to the pair
Type of pair shielding	Aluminum-lined foil
Overall twist	4 pairs for core
Shielding	Tinned copper braided shield
Optical shield covering	70 %
External sheath, color	water blue RAL 5021
Outer sheath thickness	0.65 mm
External cable diameter D	6.4 mm ±0.2 mm

Bus system flush-type socket - VS-FSBPXS-OE-94F/2,0 - 1424151

Technical data

Cable

Minimum bending radius, fixed installation	4 x D
Minimum bending radius, flexible installation	8 x D
Tensile strength GRP	≤ 100 N
Cable weight	42 kg/km
Outer sheath, material	PUR
Material conductor insulation	Foamed PE
Conductor material	Bare Cu litz wires
Insulation resistance	≥ 500 MΩ*km
Loop resistance	≤ 290.00 Ω/km
Cable capacity	47 nF/km
Wave impedance	100 Ω ±5 Ω (at 100 MHz)
Near end crosstalk attenuation (NEXT)	75.3 dB (with 1 MHz)
	66.3 dB (at 4 MHz)
	61.8 dB (at 8 MHz)
	60.3 dB (at 10 MHz)
	57.2 dB (at 16 MHz)
	55.8 dB (at 20 MHz)
	54.3 dB (at 25 MHz)
	52.8 dB (at 31.25 MHz)
	48.4 dB (at 62.5 MHz)
	45.3 dB (at 100 MHz)
	40.8 dB (at 200 MHz)
	39.3 dB (at 250 MHz)
	38.1 dB (at 300 MHz)
	36.3 dB (at 400 MHz)
	34.8 dB (at 500 MHz)
Power-summated near end crosstalk attenuation (PSNEXT)	72.3 dB (with 1 MHz)
	63.3 dB (at 4 MHz)
	58.8 dB (at 8 MHz)
	57.3 dB (at 10 MHz)
	54.2 dB (at 16 MHz)
	52.8 dB (at 20 MHz)
	51.3 dB (at 25 MHz)
	49.9 dB (at 31.25 MHz)
	45.4 dB (at 62.5 MHz)
	42.3 dB (at 100 MHz)
	37.8 dB (at 200 MHz)
	36.3 dB (at 250 MHz)
	35.1 dB (at 300 MHz)
	33.3 dB (at 400 MHz)

Bus system flush-type socket - VS-FSBPXS-OE-94F/2,0 - 1424151

Technical data

Cable

	31.8 dB (at 500 MHz)
Attenuation	3.1 dB (with 1 MHz)
	5.7 dB (at 4 MHz)
	8 dB (at 8 MHz)
	8.9 dB (at 10 MHz)
	11.2 dB (at 16 MHz)
	12.6 dB (at 20 MHz)
	14.1 dB (at 25 MHz)
	15.8 dB (at 31.25 MHz)
	22.5 dB (at 62.5 MHz)
	28.7 dB (at 100 MHz)
	41.4 dB (at 200 MHz)
	46.6 dB (at 250 MHz)
	51.4 dB (at 300 MHz)
	60.1 dB (at 400 MHz)
	67.9 dB (at 500 MHz)
Return loss (RL)	20 dB (with 1 MHz)
	23 dB (at 4 MHz)
	24.5 dB (at 8 MHz)
	25 dB (at 10 MHz)
	25 dB (at 16 MHz)
	25 dB (at 20 MHz)
	24.2 dB (at 25 MHz)
	23.3 dB (at 31.25 MHz)
	20.7 dB (at 62.5 MHz)
	19 dB (at 100 MHz)
	16.4 dB (at 200 MHz)
	15.6 dB (at 250 MHz)
	15.6 dB (at 300 MHz)
	15.6 dB (at 400 MHz)
	15.6 dB (at 500 MHz)
Signal runtime	5.13 ns/m
Shield attenuation	≥ 80 dB (at 30 ... 100 MHz)
Nominal voltage, cable	≤ 100 V
Test voltage Core/Core	700 V (50 Hz, 1 min.)
Test voltage Core/Shield	700 V (50 Hz, 1 min.)
Flame resistance	according to IEC 60332-1-2
Halogen-free	according to IEC 60754-1
Resistance to oil	in accordance with DIN EN 60811-2-1
Ambient temperature (operation)	-40 °C ... 80 °C (cable, fixed installation)

Bus system flush-type socket - VS-FSBPXS-OE-94F/2,0 - 1424151

Technical data

Cable

	-20 °C ... 80 °C (cable, flexible installation)
Ambient temperature (installation)	-20 °C ... 80 °C
Ambient temperature (storage/transport)	-20 °C ... 80 °C

Environmental Product Compliance

REACH SVHC	Lead 7439-92-1
China RoHS	Environmentally Friendly Use Period = 50 years
	For details about hazardous substances go to tab "Downloads", Category "Manufacturer's declaration"

Drawings

Dimensional drawing

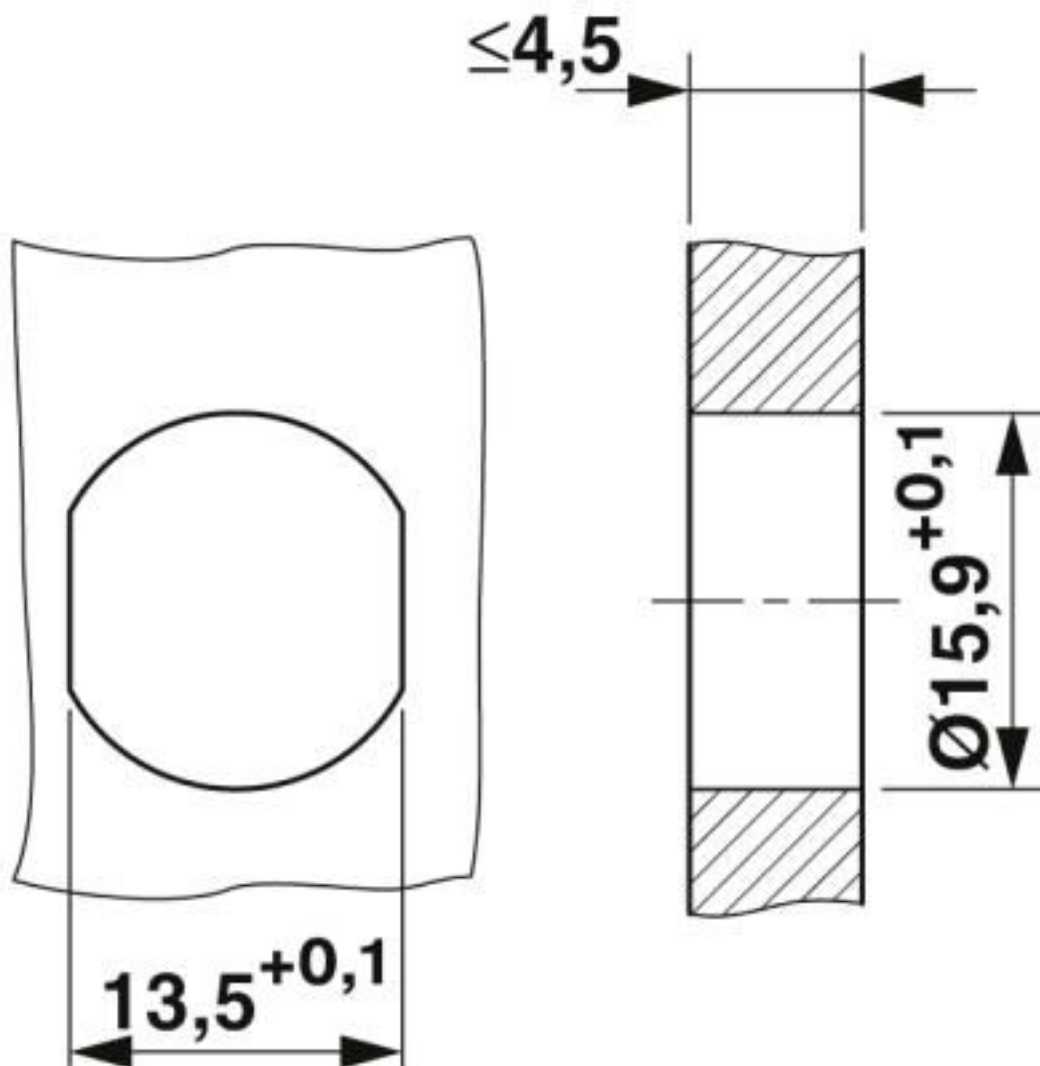

Bus system flush-type socket - VS-FSBPXS-OE-94F/2,0 - 1424151

Diagram

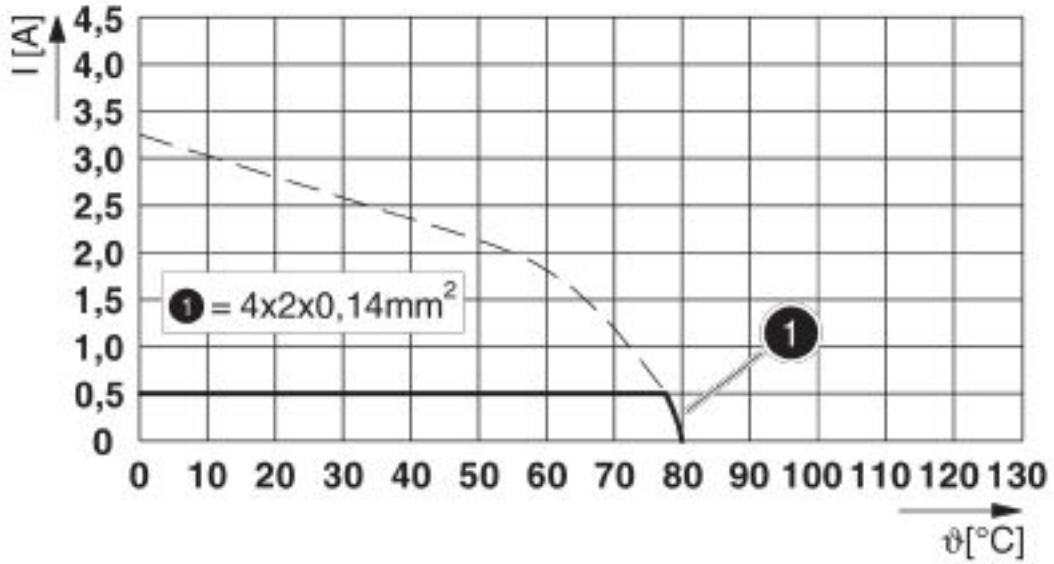

I = current strength, T = ambient temperature

Bus system flush-type socket - VS-FSBPXS-OE-94F/2,0 - 1424151

Circuit diagram

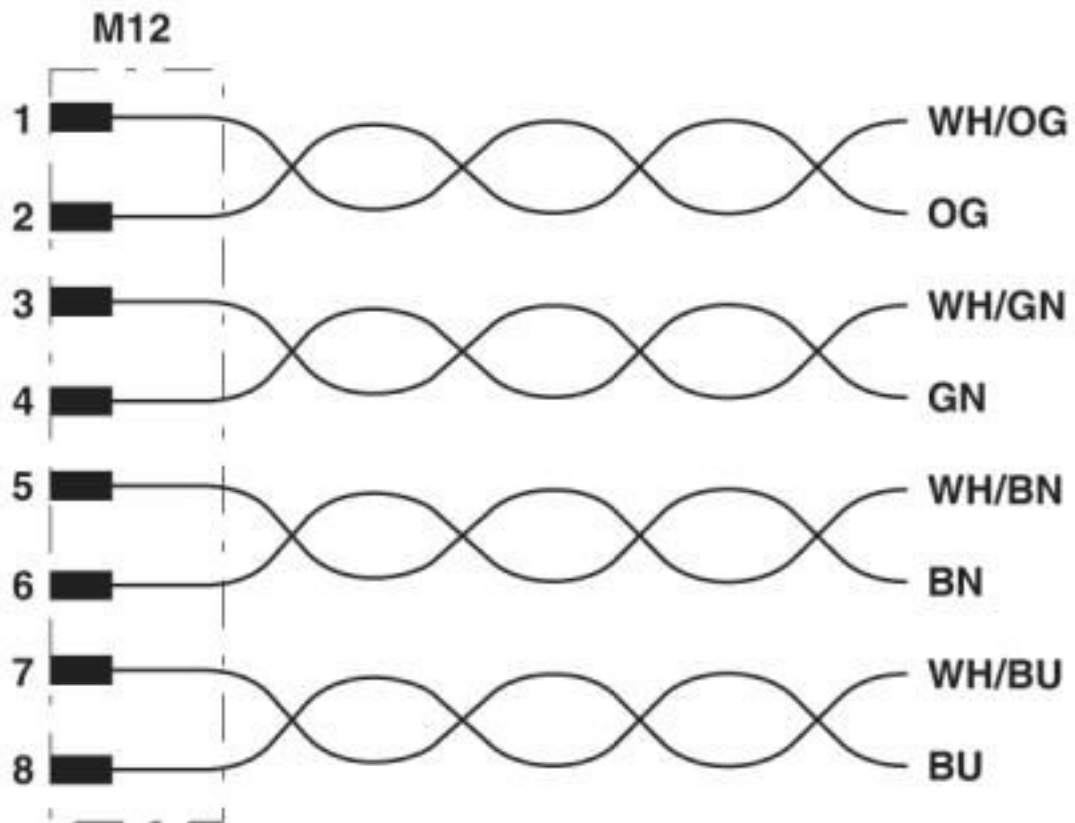

Contact assignment of the M12 plug

Bus system flush-type socket - VS-FSBPXS-OE-94F/2,0 - 1424151

Schematic diagram

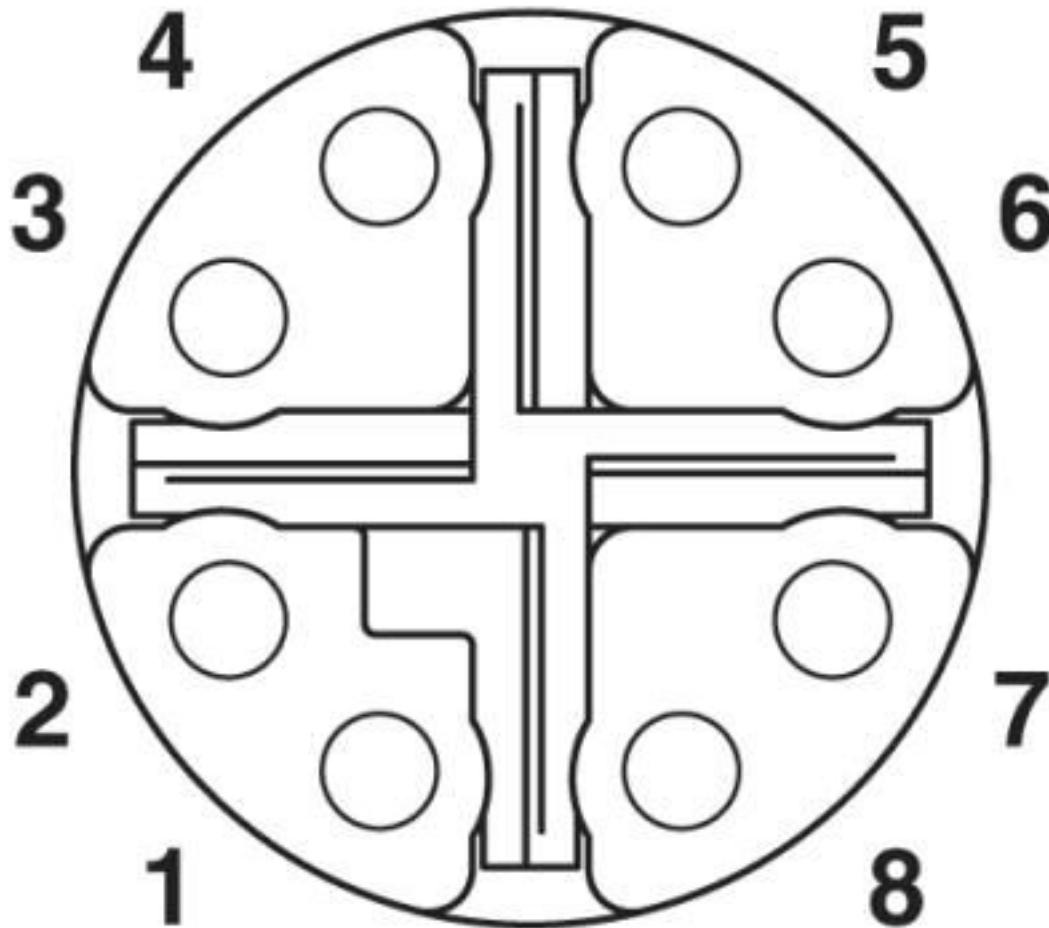

M12 socket pin assignment, 8-pos, view of socket side

Bus system flush-type socket - VS-FSBPXS-OE-94F/2,0 - 1424151

Cable cross section

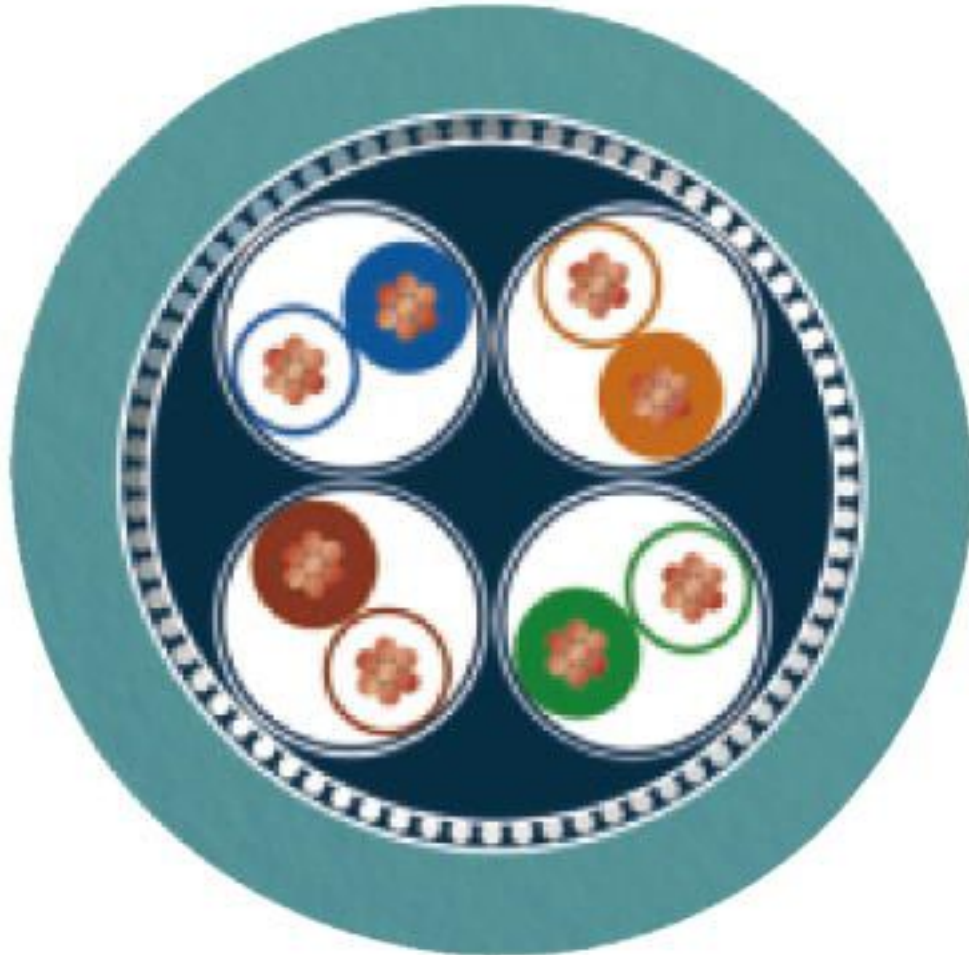

Ethernet 10 Gbit [94F]

Classifications

eCl@ss

eCl@ss 10.0.1	27060308
eCl@ss 4.0	27140800
eCl@ss 4.1	27140800
eCl@ss 5.0	27143400
eCl@ss 5.1	27143400
eCl@ss 6.0	27143400
eCl@ss 7.0	27060308
eCl@ss 8.0	27060308
eCl@ss 9.0	27060308

Bus system flush-type socket - VS-FSBPXS-OE-94F/2,0 - 1424151

Classifications

ETIM

ETIM 3.0	EC001855
ETIM 4.0	EC002062
ETIM 5.0	EC002599
ETIM 6.0	EC001262
ETIM 7.0	EC001262

UNSPSC

UNSPSC 6.01	31251501
UNSPSC 7.0901	31251501
UNSPSC 11	31251501
UNSPSC 12.01	31251501
UNSPSC 13.2	26121604
UNSPSC 18.0	26121604
UNSPSC 19.0	26121604
UNSPSC 20.0	26121604
UNSPSC 21.0	26121604

Approvals

Approvals

Approvals

UL Recognized / cUL Recognized / EAC / cULus Recognized

Ex Approvals

Approval details

UL Recognized		http://database.ul.com/cgi-bin/XYV/template/LISEXT/1FRAME/index.htm E335024-20120308
Nominal voltage UN	60 V	
Nominal current IN	0.5 A	

cUL Recognized		http://database.ul.com/cgi-bin/XYV/template/LISEXT/1FRAME/index.htm E335024-20120308
Nominal voltage UN	60 V	

Bus system flush-type socket - VS-FSBPXS-OE-94F/2,0 - 1424151

Approvals

Nominal current I _N	0.5 A
--------------------------------	-------

EAC		19060508
-----	--	----------

cULus Recognized	
------------------	--

Accessories

Accessories

Cable connector

Conductor connectors - SACC-CC-8QO SH ETH - 1414412



Cable connector, Ethernet CAT6_A (10 Gbps), 8-pos., halogen-free, shielded, insulation displacement connection, housing material: zinc die-cast, nickel-plated, outer cable diameter of 5 mm ... 9.7 mm

Circular connector (cable-side)

Data connector - SACC-MSX-8QO SH ETH SCO - 1411043



Data connector, Ethernet CAT6_A (10 Gbps), 8-position, halogen-free, shielded, Plug straight M12 SPEEDCON, Coding: X, Insulation displacement connection, knurl material: Zinc die-cast, nickel-plated, external cable diameter 5 mm ... 9.7 mm

Data connector - SACC-FSX-8QO SH ETH SCO - 1414586



Data connector, Ethernet CAT6_A (10 Gbps), 8-position, halogen-free, shielded, Socket straight M12 SPEEDCON, Coding: X, Insulation displacement connection, knurl material: Zinc die-cast, nickel-plated, external cable diameter 5 mm ... 9.7 mm

Bus system flush-type socket - VS-FSBPXS-OE-94F/2,0 - 1424151

Accessories

Data connector - VS-08-M12MS-10G-P SCO - 1417430



Data connector, Ethernet CAT6_A (10 Gbps), 8-position, shielded, Plug straight M12 SPEEDCON, Coding: X, Piercecon[®], knurl material: Zinc die-cast, nickel-plated, external cable diameter 4 mm ... 8 mm

Data connector - VS-08-M12MR-10G-P SCO - 1417443



Data connector, Ethernet CAT6_A (10 Gbps), 8-position, shielded, Plug angled M12 SPEEDCON, Coding: X, Piercecon[®], knurl material: Zinc die-cast, nickel-plated, external cable diameter 4 mm ... 8 mm

Data connector - SACC-M12MSX-8CT-CL SH - 1422844



Data connector, Ethernet/PROFINET CAT6_A (10 Gbps), 8-position, shielded, Plug straight M12, Coding: X, Crimp connection, knurl material: Zinc die-cast, nickel-plated, external cable diameter 6.5 mm ... 10 mm, without crimp contacts

Data connector - SACC-M12MRX-8CT-CL SH - 1422845



Data connector, Ethernet/PROFINET CAT6_A (10 Gbps), 8-position, shielded, Plug angled M12, Coding: X, Crimp connection, knurl material: Zinc die-cast, nickel-plated, external cable diameter 6.5 mm ... 10 mm, without crimp contacts

Corrugated pipe

Protective hose - WP-PA HF 13,0 BK - 3240681



Polyamide protective hose, inflammability class V0, UV resistant

Bus system flush-type socket - VS-FSBPXS-OE-94F/2,0 - 1424151

Accessories

Protective hose - WP-PA HF-HB 13,0 BK - 3240839



Polyamide protective hose, inflammability class HB, UV resistant

Cutting tools

Cable-cutting tool - CUTFOX 12 - 1212128



Cable cutter, for copper and aluminum up to 12 mm diameter (up to 35 mm²)

Diagonal cutter - CUTFOX-S VDE - 1212207



Diagonal cutter for hard (piano wire) and soft wires, VDE 1000 V AC/1500 V DC tested

Data plug

RJ45 connector - VS-08-RJ45-10G/Q - 1419001



RJ45 connector, IP20, CAT6_A, 8-pos., with QUICKON fast connection technology, for 26 ... 24 AWG 1-wire and 7-wire conductors, color: black

RJ45 connector - CUC-IND-C1ZNI-S/R4IE8 - 1421607



RJ45 connector, degree of protection: IP20, number of positions: 8, 1 Gbps, CAT5 (IEC 11801:2002), material: Zinc die-cast, connection method: IDC fast connection, connection cross section: AWG 26- 24, cable outlet: straight, color: green

Bus system flush-type socket - VS-FSBPXS-OE-94F/2,0 - 1424151

Accessories

RJ45 connector - CUC-IND-C1ZNI-T/R4IE8 - 1421877



RJ45 connector, degree of protection: IP20, number of positions: 8, 1 Gbps, CAT5 (IEC 11801:2002), material: Zinc die-cast, connection method: IDC fast connection, connection cross section: AWG 26- 24, cable outlet: angled

RJ45 connector - CUC-IND-C1ZNI-B/R4IE8 - 1421876



RJ45 connector, degree of protection: IP20, number of positions: 8, 1 Gbps, CAT5 (IEC 11801:2002), material: Zinc die-cast, connection method: IDC fast connection, connection cross section: AWG 26- 24, cable outlet: angled

RJ45 connector - CUC-V06-C1PGY-S/R4CEA:1 - 1414406



RJ45 connector, degree of protection: IP67, 10 Gbps, CAT6_A, material: PA, connection method: Crimp connection, connection cross section: AWG 24- 27, cable outlet: straight, color: gray

RJ45 connector - CUC-V06-C1PBK-S/R4CEA:1 - 1414410



RJ45 connector, degree of protection: IP67, number of positions: 8, 10 Gbps, CAT6_A, material: PA, connection method: Crimp connection, connection cross section: AWG 24- 27, cable outlet: straight, color: black

RJ45 connector - VS-PPC-C1-RJ45-POBK-8I10G - 1422205



RJ45 connector, IP67, with push/pull interlocking (Version 14), plastic housing, for 10 Gbps, for 24 ... 27 AWG stranded conductors

Electronics pliers

Bus system flush-type socket - VS-FSBPXS-OE-94F/2,0 - 1424151

Accessories

Diagonal cutter - MICROFOX-SP-1 - 1212487



Electronic diagonal cutter, tapered head, without chamfer, with opening spring, non-reflective phosphate-treated surface, punched version

Stripping tool

Stripping tool - WIREFOX 4 - 1212156



Stripping tool, for cables and conductors (especially for rubber and silicone insulations) from 0.1 - 4 mm², self-adjusting, stripping length of up to 18 mm, cutting capacity of up to 10 mm² stranded/1.5 mm² solid, replaceable stripping blade

Stripping tool - WIREFOX-E 4 - 1212704



Stripping tool, for cables and conductors (especially for rubber and silicone insulations) from 0.1 - 4 mm², self-adjusting, stripping length of up to 18 mm, cutting capacity of up to 10 mm² stranded/1.5 mm² solid, replaceable stripping blade

Stripping tool - WIREFOX 10 - 1212150



Stripping tool, for cables and conductors from 0.02 - 10 mm², self-adjusting, stripping length of up to 18 mm, cutting capacity of up to 10 mm² stranded/1.5 mm² solid, replaceable stripping blade

Stripping tool - VS-CABLE-STRIP-VARIO - 1657407



Stripping tool, for the multi-level stripping of shielded cables

Bus system flush-type socket - VS-FSBPXS-OE-94F/2,0 - 1424151

Accessories

Protective hose adapter - WP-CTA POM 13,0 BK - 1422884



Protective hose adapter, for corrugated hoses with a nominal size of 13 (10 x 13), corrugated in parallel

Phoenix Contact 2020 © - all rights reserved
<http://www.phoenixcontact.com>

PHOENIX CONTACT GmbH & Co. KG
Flachsmarktstr. 8
32825 Blomberg
Germany
Tel. +49 5235 300
Fax +49 5235 3 41200
<http://www.phoenixcontact.com>

X-ON Electronics

Largest Supplier of Electrical and Electronic Components

Click to view similar products for [Ethernet Cables / Networking Cables](#) category:

Click to view products by [Phoenix Contact](#) manufacturer:

Other Similar products are found below :

[73-6670-7](#) [73-6680-15](#) [73-7797-25](#) [MCJB2-10P6Q7-120](#) [84909-0204](#) [1200700174](#) [1200860368](#) [E16A06002M030](#) [E200102-009-S1](#)
[AX105346-EW](#) [MT14-187L](#) [17-103530](#) [ERWPAB3002M005](#) [190-038045-01](#) [NK5EPC18RDY](#) [NK5EPC18VLY](#) [NK5EPC18YLY](#)
[NK5EPC1GRY](#) [NK5EPC4Y](#) [NK5EPC6YLY](#) [NK5EPC8BLY](#) [NK5EPC9YLY](#) [1969343-6](#) [C501100010](#) [C501106002](#) [C501106007](#)
[C501106015](#) [C501106025](#) [C601102010](#) [C601104010](#) [C601106007](#) [C601106015](#) [2142758-2](#) [2168427-2](#) [CAT1106007](#) [21949-1](#) [2J1866A](#)
[RJF SFTP 5E 0500](#) [AX100351](#) [MN14CEC/ST](#) [C501100015](#) [C501106004](#) [C501106010](#) [C5F1108007](#) [C601104004](#) [C601106004](#)
[CA21106004](#) [CA21106010](#) [CA21106015](#) [CA21109007](#)