

## Flush-type connector - SACC-E-M8MS-8CON-M10/0,5 - 1424232

Please be informed that the data shown in this PDF Document is generated from our Online Catalog. Please find the complete data in the user's documentation. Our General Terms of Use for Downloads are valid (<http://phoenixcontact.com/download>)



Flush-type connector, 8-position, Plug, straight, M8, Front mounting, M10, Individual wires, cable length: 0.5 m, 0.14 mm<sup>2</sup>, PVC litz wire

### Your advantages

- ✓ Pre-assembled with litz wires for immediate use
- ✓ Customer-specific assemblies and litz wire lengths available
- ✓ Sealed on the litz wire side for optimum leak-tightness
- ✓ Standard pin assignments and codings for signal transmission with a uniform design-in design

### Key Commercial Data

Packing unit	1 pc
GTIN	 4 046356 712446
GTIN	4046356712446

### Technical data

#### Dimensions

Length of cable	0.5 m
-----------------	-------

#### Ambient conditions

Ambient temperature (operation)	-25 °C ... 85 °C (Plug / socket)
Degree of protection	IP67

#### General

Rated current at 40°C	1.5 A
Rated voltage	30 V AC
	30 V DC
Rated surge voltage	0.8 kV
Number of positions	8
Insulation resistance	≥ 100 MΩ

# Flush-type connector - SACC-E-M8MS-8CON-M10/0,5 - 1424232

## Technical data

### General

Coding	A - standard
Standards/regulations	M8 connector IEC 61076-2-104
Status display	No
Overvoltage category	II
Degree of pollution	3
Connection method	Individual wires
Mounting type	Front mounting M10

### Material

Flammability rating according to UL 94	HB
Contact material	Cu alloy
Contact surface material	Au
Contact carrier material	PA 6.6
Material, knurls	Zinc die-cast, nickel-plated

### Cable

Cable type	PVC litz wire
Conductor cross section	0.14 mm <sup>2</sup>
AWG signal line	26
Conductor structure signal line	7x 0.16 mm
Core diameter including insulation	1.3 mm ±0.1 mm
Thickness, insulation	0.38 mm
Wire colors	white, brown, green, yellow, gray, pink, blue, red
Material conductor insulation	PVC / UL
Conductor material	Tin-plated Cu litz wires
Standards/specifications	M8 connector IEC 61076-2-104
Insulation resistance	≥ 20 MΩ*km
Conductor resistance	≥ 80 Ω/km
Nominal voltage, cable	300 V
Test voltage, cable	2000 V AC
Ambient temperature (operation)	-40 °C ... 105 °C (cable, fixed installation)
	-10 °C ... 105 °C

### Standards and Regulations

Standards/specifications	M8 connector IEC 61076-2-104
Flammability rating according to UL 94	HB

### Environmental Product Compliance

China RoHS	Environmentally Friendly Use Period = 25;
	For details about hazardous substances go to tab "Downloads", Category "Manufacturer's declaration"

## Drawings

# Flush-type connector - SACC-E-M8MS-8CON-M10/0,5 - 1424232

Schematic diagram

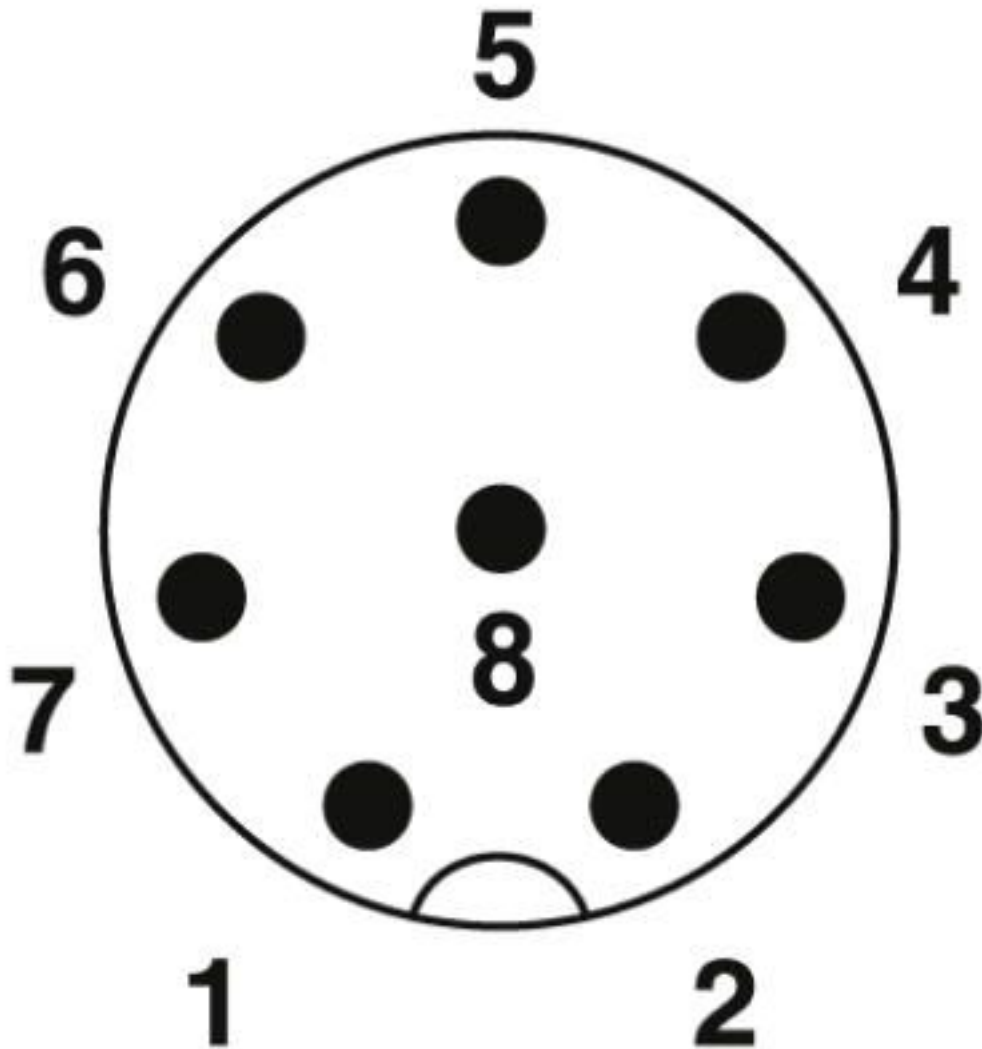

M8 plug pin assignment, 8-pos., view of pin side

# Flush-type connector - SACC-E-M8MS-8CON-M10/0,5 - 1424232

Dimensional drawing

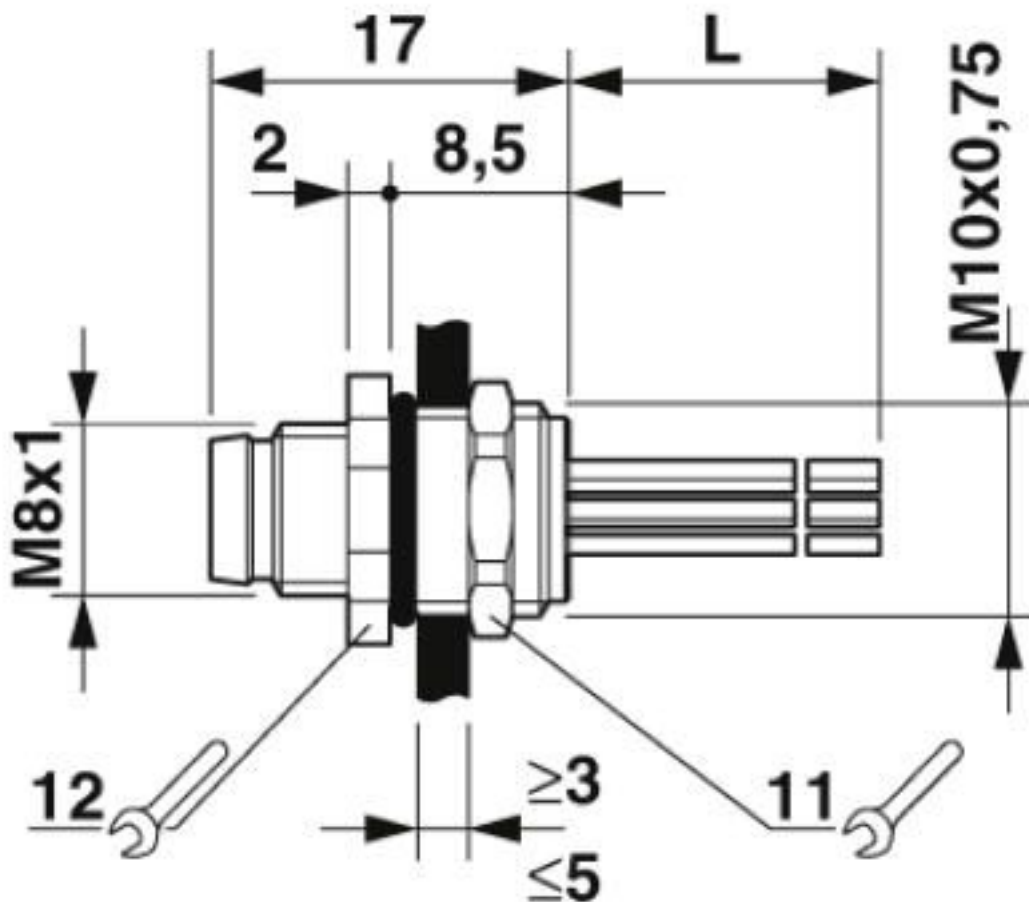

M8 flush-type plug

## Classifications

eCl@ss

eCl@ss 10.0.1	27440102
eCl@ss 4.0	27140800
eCl@ss 4.1	27140800
eCl@ss 5.0	27143400
eCl@ss 5.1	27143400
eCl@ss 6.0	27279200
eCl@ss 7.0	27440103
eCl@ss 8.0	27440103
eCl@ss 9.0	27440102

ETIM

ETIM 3.0	EC002061
----------	----------

# Flush-type connector - SACC-E-M8MS-8CON-M10/0,5 - 1424232

## Classifications

### ETIM

ETIM 4.0	EC002635
ETIM 5.0	EC002061
ETIM 6.0	EC002061

### UNSPSC

UNSPSC 6.01	31251501
UNSPSC 7.0901	31251501
UNSPSC 11	31251501
UNSPSC 12.01	31251501
UNSPSC 13.2	39121413
UNSPSC 18.0	39121413
UNSPSC 19.0	39121413
UNSPSC 20.0	39121413
UNSPSC 21.0	39121413

## Approvals

### Approvals

#### Approvals

UL Recognized / cUL Recognized / EAC / cULus Recognized

#### Ex Approvals

### Approval details

UL Recognized		<a href="http://database.ul.com/cgi-bin/XYV/template/LISEXT/1FRAME/index.htm">http://database.ul.com/cgi-bin/XYV/template/LISEXT/1FRAME/index.htm</a>	FILE E 221474
Nominal voltage UN	30 V		
Nominal current IN	1.5 A		
mm <sup>2</sup> /AWG/kcmil	26		

cUL Recognized		<a href="http://database.ul.com/cgi-bin/XYV/template/LISEXT/1FRAME/index.htm">http://database.ul.com/cgi-bin/XYV/template/LISEXT/1FRAME/index.htm</a>	FILE E 221474
Nominal voltage UN	30 V		
Nominal current IN	1.5 A		

# Flush-type connector - SACC-E-M8MS-8CON-M10/0,5 - 1424232

## Approvals

mm²/AWG/kcmil	26
---------------	----

EAC		B.01687
-----	---	---------

cULus Recognized	
------------------	---

Phoenix Contact 2020 © - all rights reserved  
<http://www.phoenixcontact.com>

PHOENIX CONTACT GmbH & Co. KG  
Flachsmarktstr. 8  
32825 Blomberg  
Germany  
Tel. +49 5235 300  
Fax +49 5235 3 41200  
<http://www.phoenixcontact.com>

## X-ON Electronics

Largest Supplier of Electrical and Electronic Components

*Click to view similar products for [Sensor Cables / Actuator Cables](#) category:*

*Click to view products by [Phoenix Contact](#) manufacturer:*

Other Similar products are found below :

[60963](#) [60964](#) [703000D02F2002](#) [703001D02F0602](#) [703001D02F300](#) [704000D02F120](#) [773032K02F030](#) [802027107404-1](#) [802027213811-1](#)  
[804001A09M150](#) [805001A09M0502](#) [84914-0235](#) [84914-0237](#) [885030A09M020](#) [8R4J30E03C3003](#) [1200651332](#) [1200651713](#) [1200660844](#)  
[1200660845](#) [1200661173](#) [1200680071](#) [1200720053](#) [1200720081](#) [1200720099](#) [1200720217](#) [1200800231](#) [1200860125](#) [1200870123](#)  
[1200980102](#) [1200650267](#) [1200650298](#) [1200660183](#) [1200660782](#) [1200660849](#) [1200661295](#) [1200661297](#) [1200661342](#) [1200661343](#)  
[1200670080](#) [1200670220](#) [1200680331](#) [1200720252](#) [1200730184](#) [1200860344](#) [1200870359](#) [1200870643](#) [1200980008](#) [1200980031](#)  
[1210502211](#) [1210400542](#)