

Data connector - SACC-M12FS-4PL SH CCL - 1424700

Please be informed that the data shown in this PDF Document is generated from our Online Catalog. Please find the complete data in the user's documentation. Our General Terms of Use for Downloads are valid (<http://phoenixcontact.com/download>)



Data connector, CC link (10 Mbps), 4-position, shielded, Socket straight M12, Coding: A, Push-in connection, knurl material: Zinc die-cast, nickel-plated, external cable diameter 4 mm ... 8 mm

Your advantages

- ✓ Easy and tool-free connection by means of Push-in Technology
- ✓ Conveniently connect stranded conductors, thanks to lever
- ✓ Reliable and quick connection of electric cables
- ✓ Flexible signal and data cabling
- ✓ Quick and easy installation, thanks to Push-in connection technology



CCLink

Key Commercial Data

Packing unit	1 pc
GTIN	 4 055626 376271
GTIN	4055626376271

Technical data

Dimensions

Diameter housing	19 mm
Length	59 mm
External cable diameter	4 mm ... 8 mm
Stripping length of the sheath	29 mm
Stripping length of the individual wire	7 mm

Ambient conditions

Ambient temperature (operation)	-40 °C ... 85 °C (Plug / socket)
Degree of protection	IP65
	IP67

General

Data connector - SACC-M12FS-4PL SH CCL - 1424700

Technical data

General

Note	NOTE: Observe the permissible bending radii when laying conductors, since the degree of protection may be put in jeopardy if the bending forces are too high. Alleviate mechanical loads upstream of the connector, e.g. by using cable ties.
Rated current at 40°C	4 A (2 A when using 0.14 mm ² conductors)
Rated voltage	48 V AC
	60 V DC
Number of positions	4
Insulation resistance	≥ 100 MΩ
Coding	A - standard
Standards/regulations	M12 connector IEC 61076-2-101
	Shock, vibration EN 50155:2001
Signal type/category	CC link, 10 Mbps
Status display	No
Overvoltage category	II
Degree of pollution	3
Connection method	Push-in connection
Conductor cross section	0.14 mm ² ... 0.75 mm ² (without ferrule)
	0.08 mm ² ... 0.5 mm ² (with ferrule)
	0.14 mm ² ... 0.75 mm ² (solid)
Conductor cross section AWG	26 ... 18 (without ferrule)
	28 ... 20 (with ferrule)
Insertion/withdrawal cycles	≥ 100
Torque	0.4 Nm (M12 knurl)
	0.8 Nm (Connector with coupling sleeve)
	3 Nm (Pressure nut with coupling sleeve)
Assembly instructions	The wires can be connected both with ferrules and without ferrules

Material

Flammability rating according to UL 94	V0
Contact material	CuSn
Contact surface material	Ni/Au
Contact carrier material	PA 6.6
Material of grip body	Zinc die-cast, nickel-plated
Material, knurls	Zinc die-cast, nickel-plated
Sealing material	NBR
Additional material specifications	TPE-U (Clamping cage, weight: 1.1 g)
	PA 6 (Actuation lever)
Standards/regulations	PA 6.6: Fire protection in rail vehicles - requirement sets R22, R23, R24, R25, and R26 acc. to DIN EN 45545-2 (Risk level HL1 - HL3)
	PA 6: Fire protection in rail vehicles - requirement sets R22, R23, and R24 acc. to DIN EN 45545-2 (Risk level HL1 - HL3)

Data connector - SACC-M12FS-4PL SH CCL - 1424700

Technical data

Standards and Regulations

Standards/specifications	M12 connector IEC 61076-2-101
	Shock, vibration EN 50155:2001
Flammability rating according to UL 94	V0
Standards/regulations	acc. to DIN EN 45545-2

Environmental Product Compliance

China RoHS	Environmentally friendly use period: unlimited = EFUP-e
	No hazardous substances above threshold values

Drawings

Data connector - SACC-M12FS-4PL SH CCL - 1424700

Functional drawing

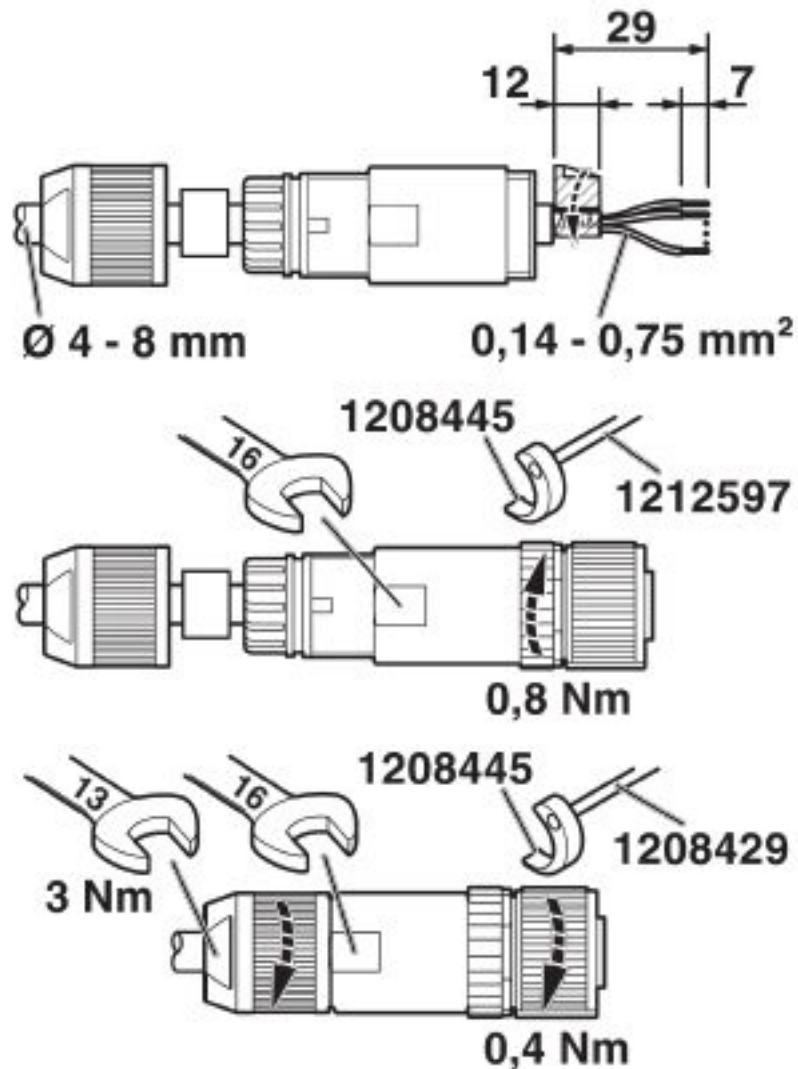

Slide the pressure nut and sleeve housing along the cable, strip the cable, shorten the shield, strip the single wires, connect the wires, in the case of a straight sleeve housing gently twist the wires together, stick the shielding foil around the shortened shield, in the case of a cable outside diameter $< 6 \text{ mm}$ stick an additional shielding foil around the wire pack, screw the sleeve housing to the plug insert, screw the pressure nut tight.

Data connector - SACC-M12FS-4PL SH CCL - 1424700

Dimensional drawing

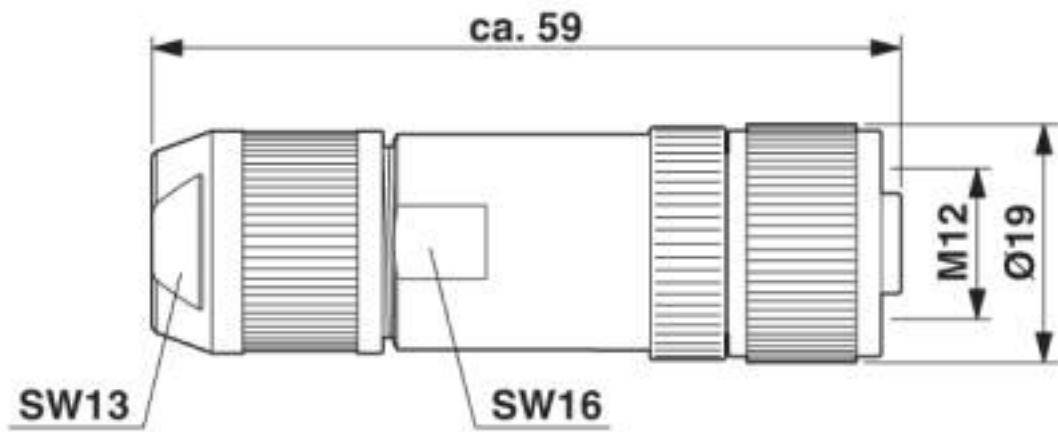

Socket M12-SPEEDCON, straight, shielded

Data connector - SACC-M12FS-4PL SH CCL - 1424700

Schematic diagram

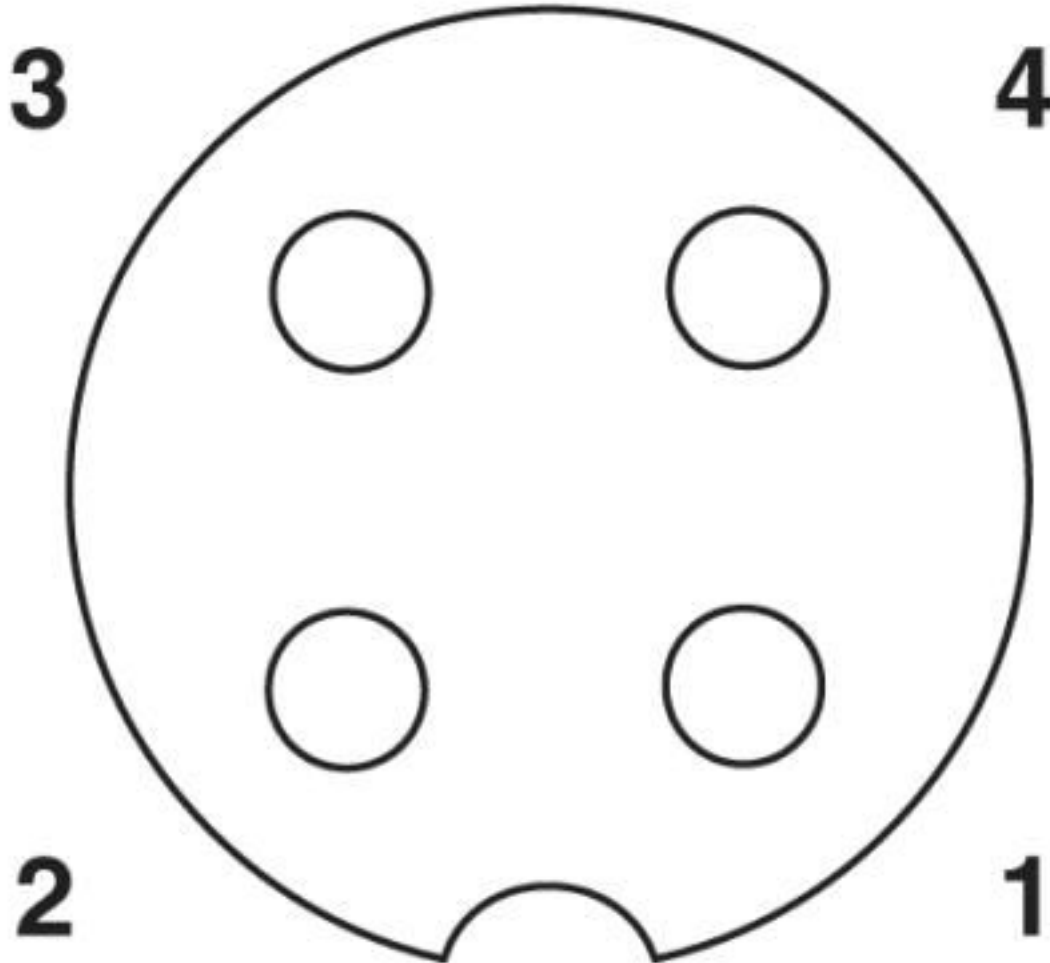

Pin assignment M12 socket, 4-pos., A-coded, view female side

Classifications

eCl@ss

eCl@ss 10.0.1	27440102
eCl@ss 5.1	27143423
eCl@ss 6.0	27279200
eCl@ss 7.0	27440104
eCl@ss 8.0	27440104
eCl@ss 9.0	27440102

ETIM

ETIM 5.0	EC002635
ETIM 6.0	EC002635
ETIM 7.0	EC002635

Data connector - SACC-M12FS-4PL SH CCL - 1424700

Approvals

Approvals

Approvals

EAC / UL Listed / cUL Listed / EAC / cULus Listed

Ex Approvals

Approval details

EAC			RU C-DE.AI30.B.01102
-----	---	--	----------------------

UL Listed		http://database.ul.com/cgi-bin/XYV/template/LISEXT/1FRAME/index.htm	E221474
Nominal voltage UN		60 V	
Nominal current IN		4 A	
mm ² /AWG/kcmil		26-18	

cUL Listed		http://database.ul.com/cgi-bin/XYV/template/LISEXT/1FRAME/index.htm	E221474
Nominal voltage UN		60 V	
Nominal current IN		4 A	
mm ² /AWG/kcmil		26-18	

EAC			RU C-DE.BL08.B.00511
-----	---	--	----------------------

cULus Listed			
--------------	---	--	--

Accessories

Accessories

Cable end sleeve

Data connector - SACC-M12FS-4PL SH CCL - 1424700

Accessories

Ferrule - AI 0,25- 6 YE - 3203024



Ferrule, sleeve length: 6 mm, length: 10.5 mm, color: yellow

Ferrule - A 0,25- 7 - 3202478



Ferrule, length: 7 mm, color: silver

Ferrule - A 0,34- 7 - 3009202



Ferrule, length: 7 mm, color: silver

Ferrule - A 0,5 - 6 - 3200218



Ferrule, length: 6 mm, color: silver

Ferrule - AI 0,5 - 6 WH - 3200687



Ferrule, sleeve length: 6 mm, length: 12 mm, color: white

Crimping tool

Data connector - SACC-M12FS-4PL SH CCL - 1424700

Accessories

Crimping pliers - CRIMPFOX 6H - 1212046



Crimping pliers, for ferrules without insulating collar according to DIN 46228 Part 1 and ferrules with insulating collar according to DIN 46228 Part 4, 0.14 mm² ... 6 mm², unlockable pressure lock, lateral entry

Data cable preassembled

Bus system cable - SAC-4P-M12MS/ 2,0-990 - 1558328



Bus system cable, CC link (10 Mbps), 4-position, PVC, red, shielded, Plug straight M12, coding: A, on free cable end, cable length: 2 m

Plug for cable screw gland

Screw plug - PROT-M12 MS-PA-CHAIN - 1430899

M12 sealing cap with fixing band, for sensor cables, for free M12 sockets



Screwdriver tools

Tool - SACC BIT M12-D20 - 1208445

Nut for assembling M12 connectors for assembly with a knurl diameter of 20 mm, for 4 mm hexagonal drive



Adapter insert - TSD-M SAC-BIT ADAPTER - 1212600



Adapter bit for TSD-M...torque tools, E6.3-1/4" drive with 4 mm hexagon to accommodate SAC bits

Shield connection

Data connector - SACC-M12FS-4PL SH CCL - 1424700

Accessories

Shielding foil - ALU-SB - 1404531

Shielding foil, for fixing the braided shield of shielded cables. Length: 4 cm, width: 1.2 cm



Stripping tool

Stripping tool - WIREFOX 2,5 - 1212368



Stripping tool, for conductors and cables with a conductor cross section from 0.08 to 2.5 mm, self-adjusting, stripping length adjustable up to 15 mm, cutting capacity up to 6 mm² stranded/1.5 mm² solid

Torque tool

Torque screwdriver - TSD 04 SAC - 1208429



Torque screwdriver, with preset torque of 0.4 Nm and 4 mm hexagonal drive for M12 connectors

Torque screwdriver - TSD 08 SAC - 1212597



Torque screw driver with preset torque of 0.8 Nm, with 4 mm hexagon for accommodating SAC bits, two-component handle with non-slip grip

Torque screwdriver - TSD-M 1,2NM - 1212224



Torque screw driver, accuracy as per EN ISO 6789 standard, adjustable from 0.3 - 1.2 Nm

Data connector - SACC-M12FS-4PL SH CCL - 1424700

Accessories

Torque screwdriver - TSD-M 3NM - 1212225



Torque screw driver, accuracy as per EN ISO 6789 standard, adjustable from 1.2 - 3 Nm

Stripping tool - VS-CABLE-STRIP-VARIO - 1657407



Stripping tool, for the multi-level stripping of shielded cables

Phoenix Contact 2020 © - all rights reserved
<http://www.phoenixcontact.com>

PHOENIX CONTACT GmbH & Co. KG
Flachsmarktstr. 8
32825 Blomberg
Germany
Tel. +49 5235 300
Fax +49 5235 3 41200
<http://www.phoenixcontact.com>

X-ON Electronics

Largest Supplier of Electrical and Electronic Components

Click to view similar products for [Circular Metric Connectors](#) category:

Click to view products by [Phoenix Contact](#) manufacturer:

Other Similar products are found below :

[600X518037X](#) [6STD15PCR99B70A](#) [8R4000A16M020](#) [8R5000A16M005](#) [1200910002](#) [1203580030](#) [1200910008](#) [1200910011](#) [1300140094](#)
[130203-0054](#) [1300140026](#) [1300150099](#) [RF-12S1N8A90DU](#) [1-3637-600-5205](#) [1612618](#) [21036836414](#) [8R4006A16M010](#) [1604232](#)
[1R3006A20M005](#) [RF-12P1N8A80DU](#) [RF-12P1N8A90DU](#) [41-40011](#) [42-00006](#) [42-01015](#) [4-22279-4](#) [4-22281-1](#) [4-22284-9](#) [43-00113](#) [43-](#)
[01088](#) [43-01203](#) [41-40013](#) [42-00008](#) [43-00343](#) [43-01026](#) [43-01162](#) [43-01173](#) [43-10000](#) [XS3P-M421-2](#) [600X518050X](#) [SACC-DSI-FS-5P-](#)
[PG9-L180 SC](#) [8R5006A16M020](#) [8R5006A16M005](#) [8R4000A16M010](#) [6-22279-3](#) [1605332](#) [N03FA03144](#) [1300140077](#) [43-16213](#) [43-01338](#)
[XS2RD4265](#)