

Housing - HC-STA-B32-SHWD-2SSM40-ELC-AL - 1424849

Please be informed that the data shown in this PDF Document is generated from our Online Catalog. Please find the complete data in the user's documentation. Our General Terms of Use for Downloads are valid (<http://phoenixcontact.com/download>)



Box mounting bases B32, with double locking latch, material: Die-cast aluminum, salt water resistant, cable outlets: 2, lateral, height: 90 mm, cable gland: none, support sleeve: yes, 2x M40, Standard

Your advantages

- ✔ good shielding in the event of electromagnetic interference



Key Commercial Data

Packing unit	1 pc
GTIN	
GTIN	4055626382548

Technical data

Dimensions

Height	90 mm
Width	94 mm
Length	125 mm

Ambient conditions

Degree of protection (IP)	IP66
	IP67
Ambient temperature (operation)	-40 °C ... 125 °C

General

Size	B32
Housing type	Box mounting bases
Color	gray aluminum
Locking type	with double locking latch
No. of cable outlets	2
Cable outlet	lateral

Housing - HC-STA-B32-SHWD-2SSM40-ELC-AL - 1424849

Technical data

General

Screw connection	none
Type of the screw connection	2x M40
Housing material	Die-cast aluminum, salt water resistant
Housing surface material	uncoated
Seal material	NBR, conductive
Material lock	PA
Flammability rating according to UL 94	V0 (Interlock)
Assembly instructions	One opening is sealed with a plastic filler plug and can be opened using a screwdriver.

Environmental Product Compliance

China RoHS	Environmentally Friendly Use Period = 50 years
	For details about hazardous substances go to tab "Downloads", Category "Manufacturer's declaration"

Drawings

Dimensional drawing

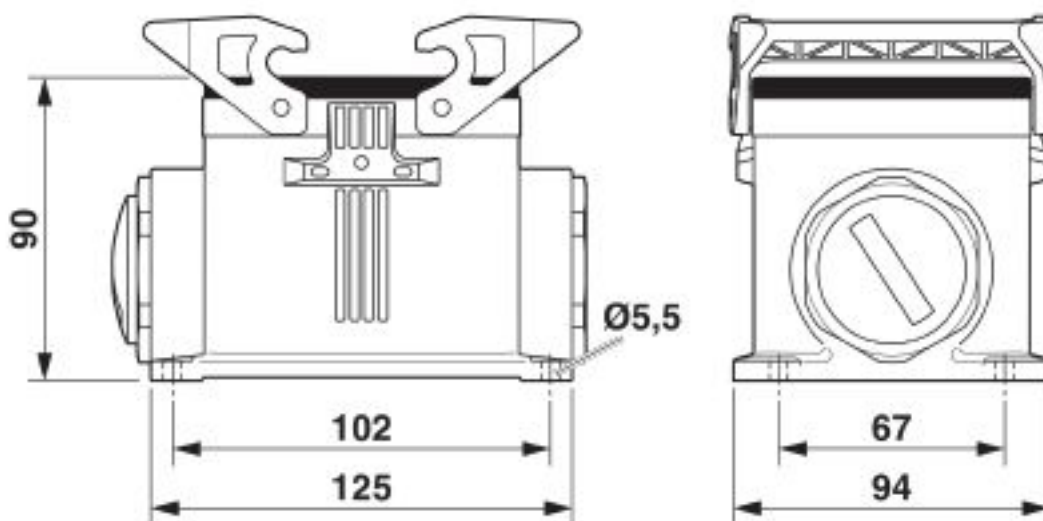

Dimensional drawing

Classifications

eCl@ss

eCl@ss 10.0.1	27440202
eCl@ss 5.1	27261200
eCl@ss 6.0	27261200

Housing - HC-STA-B32-SHWD-2SSM40-ELC-AL - 1424849

Classifications

eCl@ss

eCl@ss 7.0	27440202
eCl@ss 8.0	27440202
eCl@ss 9.0	27440202

ETIM

ETIM 5.0	EC000437
ETIM 6.0	EC000437
ETIM 7.0	EC000437

Approvals

Approvals

Approvals

DNV GL

Ex Approvals

Approval details

DNV GL		https://approvalfinder.dnvgl.com/	TAE000037S
--------	---	---	------------

Accessories

Accessories

Protective cover

Protective covers - HC-STA-B32-BCSFD-PL-BK - 1424850



Protective cover B32, for double locking latch, protective cover material: PA, height: 24.8 mm, seal: no, Standard, with lanyard

Phoenix Contact 2020 © - all rights reserved
<http://www.phoenixcontact.com>

PHOENIX CONTACT GmbH & Co. KG
Flachmarktstr. 8
32825 Blomberg
Germany
Tel. +49 5235 300
Fax +49 5235 3 41200
<http://www.phoenixcontact.com>

X-ON Electronics

Largest Supplier of Electrical and Electronic Components

Click to view similar products for [Heavy Duty Power Connectors](#) category:

Click to view products by [Phoenix Contact](#) manufacturer:

Other Similar products are found below :

[647757-1](#) [6643411-1](#) [6646058-2](#) [6646137-1](#) [6646138-1](#) [6646479-1](#) [6646608-1](#) [6646786-1](#) [6646940-1](#) [6651091-1](#) [6651525-1](#) [6651529-1](#)
[6651788-1](#) [696475-1](#) [702-32-01109](#) [703-25-02205](#) [73000005059](#) [73000005642](#) [73080255059](#) [73080965046](#) [765-15-0080A](#) [765-16-0080B](#)
[765-18-0080D](#) [829992-1](#) [902-77-02113](#) [PS00/A0620/6300](#) [PS25/A0420/63](#) [129-1J](#) [1409400](#) [AN0024023](#) [E6374G1](#) [e6389g2](#) [157-43GW8](#)
[MS3117-14AC](#) [1643543-1](#) [1650540-1](#) [1651811-2](#) [1766260-1](#) [1766282-1](#) [1766966-1](#) [1791340000](#) [NLDFT-3-BL-L-S120-M40A](#) [NLDFT-N-](#)
[W-L-C240-M40B](#) [NLS-2-R-C240-M40B](#) [NLS-N-W-C240-M40B](#) [NPS-3-BL-T6](#) [1986615-1](#) [2-1589900-8](#) [2199314-1](#) [KA8102](#)