

Bus system cable - SAC-6P-10,0-970/FR SCO - 1428636

Please be informed that the data shown in this PDF Document is generated from our Online Catalog. Please find the complete data in the user's documentation. Our General Terms of Use for Downloads are valid (<http://phoenixcontact.com/download>)



Bus system cable, VARAN (100 Mbps), 6-position, SANTOPRENE halogen-free/TPE halogen-free, black RAL 9005, shielded, free cable end, on Socket angled M12 SPEEDCON, coding: A, cable length: 10 m



Key Commercial Data

Packing unit	1 pc
GTIN	
GTIN	4046356322911

Technical data

Dimensions

Length of cable	10 m
Stripping length of the free conductor end	50 mm

Ambient conditions

Ambient temperature (operation)	-25 °C ... 90 °C (Plug / socket)
Degree of protection	IP65
	IP67

General

Rated current at 40°C	2 A
Rated voltage	30 V AC
	30 V DC
Number of positions	6
Color handle area	black
Insulation resistance	≥ 100 MΩ
Coding	A - standard
Signal type/category	VARAN, 100 Mbps
Status display	No
Overvoltage category	II

Bus system cable - SAC-6P-10,0-970/FR SCO - 1428636

Technical data

General

Degree of pollution	3
Torque	0.4 Nm (M12 connector)

Material

Flammability rating according to UL 94	HB
Contact material	CuZn
Contact surface material	Ni/Au
Contact carrier material	TPU GF
Material of grip body	TPU, hardly inflammable, self-extinguishing
Material, knurls	Zinc die-cast, nickel-plated
Sealing material	NBR

Pin assignment

Contact Color (signal designation) Contact (optional)	1 (Socket)
	4 (Socket)
	6 (Socket) BU (Power)
	7 (Socket) BN (Power)
	5 (Socket) GN/WH (RD+)
	8 (Socket) GN (RD-)
	2 (Socket) OG/WH (TD+)
	3 (Socket) OG (TD-)

Standards and Regulations

Flammability rating according to UL 94	HB
--	----

Cable

Cable type	VARAN
Cable type (abbreviation)	970
Cable abbreviation	Li9YD12Y
Cable structure	1x2xAWG22/19 + 1x4xAWG24/19
Conductor cross section	4x 0.25 mm ² (Signal line)
	2x 0.38 mm ² (Power supply)
AWG signal line	24
AWG power supply	22
Conductor structure signal line	19x 0.13 mm
Conductor structure, voltage supply	19x 0.16 mm
Core diameter including insulation	1.35 mm (Signal line)
	1.5 mm (Power supply)
Wire colors	Brown, blue, white/orange, white/green, green, orange
Type of pair shielding	Tinned copper braided shield, 95 % covering
Overall twist	1 star quad and 2 wires with 2 fillers
Shielding	Tinned copper-braided shield, approx. 85% covering
External sheath, color	black RAL 9005

Bus system cable - SAC-6P-10,0-970/FR SCO - 1428636

Technical data

Cable

External cable diameter D	7.8 mm ±0.2 mm
Smallest bending radius, fixed installation	≥ 93 mm
Smallest bending radius, movable installation	≥ 93 mm
Number of bending cycles	3000000
Bending radius	93 mm
Traversing path	2 m
Traversing rate	1 m/s
Acceleration	2 m/s ²
Cable weight	81 kg/km
Outer sheath, material	SANTOPRENE halogen-free
Material, inner sheath	TPE
Material, filler	Yarn
Material conductor insulation	PP
Conductor material	Bare Cu litz wires
Insulation resistance	5 GΩ*km (Data cable)
Conductor resistance	77 Ω/m (Data cable)
Transmission characteristics (category)	CAT5 (IEC 11801:2002)
Working capacitance	50 nF (Data cable)
Wave impedance	100 Ω ±15 %
Nominal voltage, cable	125 V (Data cable)
	48 V (Power supply)
Test voltage, cable	2000 V (Power supply)
	max. 700 V AC (Data cable)
Halogen-free	in accordance with DIN EN 50267-2-1
Ambient temperature (operation)	-20 °C ... 80 °C (Cable)

Environmental Product Compliance

REACH SVHC	Lead 7439-92-1
China RoHS	Environmentally Friendly Use Period = 50 years
	For details about hazardous substances go to tab "Downloads", Category "Manufacturer's declaration"

Drawings

Bus system cable - SAC-6P-10,0-970/FR SCO - 1428636

Schematic diagram



Pin assignment M12 socket, 8-pos., A-coded, view female side

Bus system cable - SAC-6P-10,0-970/FR SCO - 1428636

Dimensional drawing

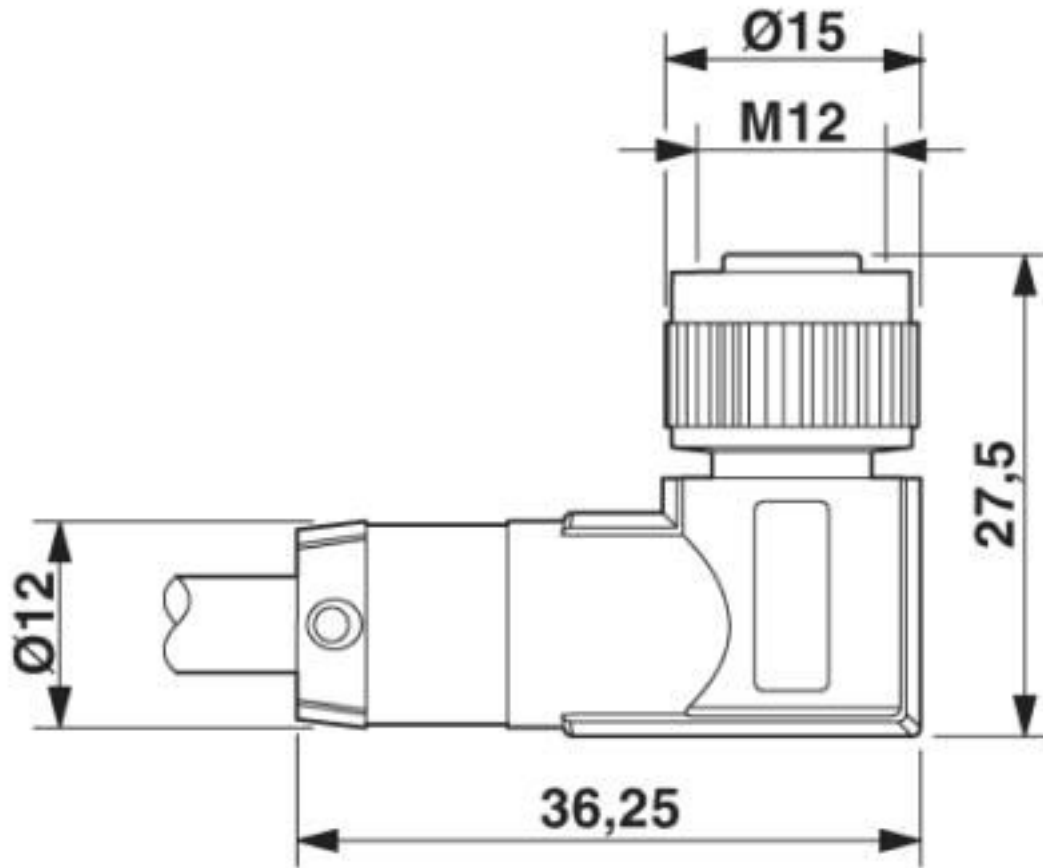

M12 x 1 socket, angled, shielded

Bus system cable - SAC-6P-10,0-970/FR SCO - 1428636

Circuit diagram

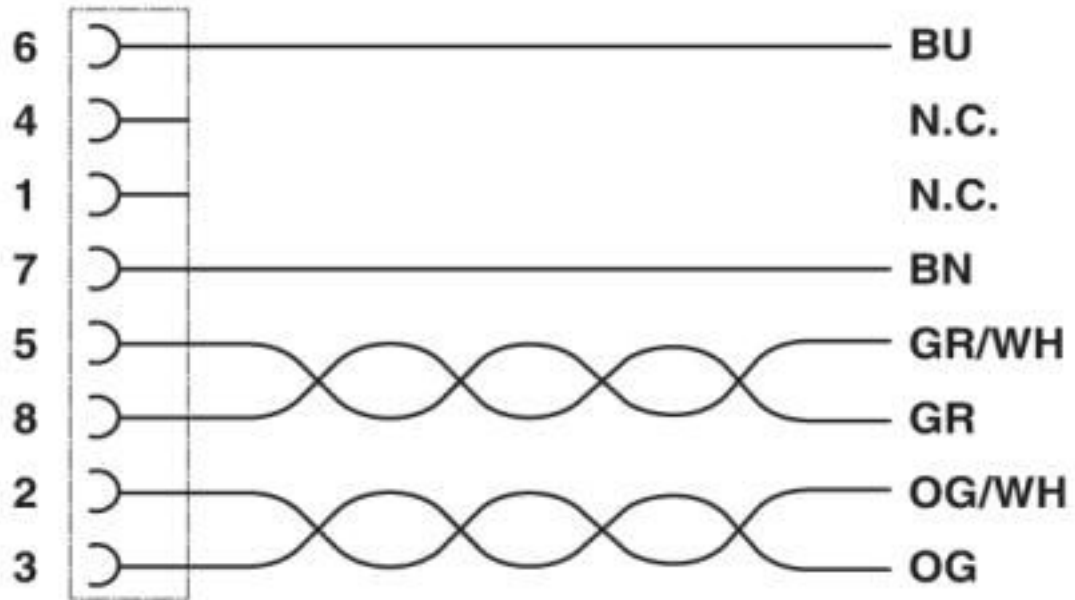

Contact assignment of the M12 socket

Bus system cable - SAC-6P-10,0-970/FR SCO - 1428636

Cable cross section



VARAN [970]

Classifications

eCl@ss

eCl@ss 10.0.1	27060308
eCl@ss 4.0	27060300
eCl@ss 4.1	27060300
eCl@ss 5.0	27061800
eCl@ss 5.1	27061800
eCl@ss 6.0	27279200
eCl@ss 7.0	27279218
eCl@ss 8.0	27279218
eCl@ss 9.0	27060308

Bus system cable - SAC-6P-10,0-970/FR SCO - 1428636

Classifications

ETIM

ETIM 3.0	EC001855
ETIM 4.0	EC001855
ETIM 5.0	EC002599
ETIM 6.0	EC001262
ETIM 7.0	EC001262

UNSPSC

UNSPSC 6.01	31251501
UNSPSC 7.0901	31251501
UNSPSC 11	31251501
UNSPSC 12.01	31251501
UNSPSC 13.2	31251501
UNSPSC 18.0	26121604
UNSPSC 19.0	26121604
UNSPSC 20.0	26121604
UNSPSC 21.0	26121604

Approvals

Approvals

Approvals

EAC-RoHS / EAC

Ex Approvals

Approval details

EAC-RoHS		RU D- DE.HB35.B.00387
----------	---	--------------------------

EAC		RU C- DE.BL08.B.00286
-----	---	--------------------------

Phoenix Contact 2020 © - all rights reserved
<http://www.phoenixcontact.com>

PHOENIX CONTACT GmbH & Co. KG
Flachsmarktstr. 8
32825 Blomberg
Germany
Tel. +49 5235 300
Fax +49 5235 3 41200
<http://www.phoenixcontact.com>

X-ON Electronics

Largest Supplier of Electrical and Electronic Components

Click to view similar products for [Sensor Cables / Actuator Cables](#) category:

Click to view products by [Phoenix Contact](#) manufacturer:

Other Similar products are found below :

[60963](#) [60964](#) [703000D02F2002](#) [703001D02F0602](#) [703001D02F300](#) [704000D02F120](#) [773032K02F030](#) [802027107404-1](#) [802027213811-1](#)
[804001A09M150](#) [805001A09M0502](#) [84914-0235](#) [84914-0237](#) [885030A09M020](#) [8R4J30E03C3003](#) [1200651332](#) [1200651713](#) [1200660844](#)
[1200660845](#) [1200661173](#) [1200680071](#) [1200720053](#) [1200720081](#) [1200720099](#) [1200720217](#) [1200800231](#) [1200860125](#) [1200870123](#)
[1200980102](#) [1200650267](#) [1200650298](#) [1200660183](#) [1200660782](#) [1200660849](#) [1200661295](#) [1200661297](#) [1200661342](#) [1200661343](#)
[1200670080](#) [1200670220](#) [1200680331](#) [1200720252](#) [1200730184](#) [1200860344](#) [1200870359](#) [1200870643](#) [1200980008](#) [1200980031](#)
[1210502211](#) [1210400542](#)