

Bus system cable - SAC-4P-M12MS/15,0-960/M12FS VA - 1431319

Please be informed that the data shown in this PDF Document is generated from our Online Catalog. Please find the complete data in the user's documentation. Our General Terms of Use for Downloads are valid (<http://phoenixcontact.com/download>)



Bus system cable, FOUNDATION Fieldbus (31.25 kbps), 3-position, PVC, orange RAL 2003, shielded, Plug straight M12, coding: A, on Socket straight M12, coding: A, cable length: 15 m



Key Commercial Data

Packing unit	1 pc
GTIN	 4 046356 431798
GTIN	4046356431798

Technical data

Dimensions

Length of cable	15 m
-----------------	------

Ambient conditions

Ambient temperature (operation)	-25 °C ... 90 °C (Plug / socket)
Degree of protection	IP65
	IP67
	IP68
	IP69K

General

Note	Further products with variable cable type and variable cable length can be found in the accessories section
Rated current at 40°C	4 A
Rated voltage	48 V AC
	60 V DC
Number of positions	3
Color handle area	black
Insulation resistance	≥ 100 MΩ
Coding	A - standard

Bus system cable - SAC-4P-M12MS/15,0-960/M12FS VA - 1431319

Technical data

General

Signal type/category	FOUNDATION Fieldbus, 31.25 kbps
Status display	No
Overvoltage category	II
Degree of pollution	3
Insertion/withdrawal cycles	≥ 100
Torque	0.4 Nm (M12 connector)

Material

Flammability rating according to UL 94	HB
Contact material	CuSn
Contact surface material	Ni/Au
Contact carrier material	TPU GF
Material of grip body	TPU, hardly inflammable, self-extinguishing
Material, knurls	Stainless steel
Sealing material	NBR

Standards and Regulations

Flammability rating according to UL 94	HB
--	----

Cable

Cable type	FOUNDATION Fieldbus orange
Cable type (abbreviation)	960
Cable structure	2xAWG18/7 + 1xAWG20/7
Conductor cross section	2x 0.75 mm ² (Signal line) 1x 0.5 mm ² (Drain wire)
AWG signal line	18
Conductor structure signal line	7x 0.40 mm
Core diameter including insulation	2.24 mm ±0.05 mm
Thickness, insulation	0.5 mm
Wire colors	Blue, orange
Twisted pairs	2 cores to the pair
Overall twist	One pair with one drain wire and fillers for core
Shielding	Plastic-coated aluminum foil with a drain wire
Optical shield covering	100 %
External sheath, color	orange RAL 2003
Outer sheath thickness	1 mm
External cable diameter D	7.5 mm ±0.25 mm
Smallest bending radius, fixed installation	75 mm
Cable weight	56.552 kg/km
Tensile strength GRP	260 N
Outer sheath, material	PVC
Material conductor insulation	PO (Signal line)

Bus system cable - SAC-4P-M12MS/15,0-960/M12FS VA - 1431319

Technical data

Cable

Conductor material	Tin-plated Cu litz wires
Conductor resistance	≤ 19.35 Ω/km (Signal line)
	26 Ω/km (shield)
Working capacitance	78 nF (at 1 kHz)
Cable capacity	147 pF/m (at 1 kHz, core/shield)
	≤ 3.94 pF/m (capacitance unbalance)
Signal speed	0.66 c
Shield attenuation	3 dB/km (at 39 kHz)
Cable impedance	100 Ω ±20 % (At 31.25 kHz)
Conductor inductance	0.6233 μH/m
Nominal voltage, cable	300 V
Special properties	UL standards PLTC-ER and ITC
Flame resistance	UL 1685 (CSA FT 4)
	UL 1685 (vertical tray)
	UL 1666 (riser)
Ambient temperature (operation)	-40 °C ... 105 °C (cable, fixed installation)

Environmental Product Compliance

China RoHS	Environmentally Friendly Use Period = 50 years
	For details about hazardous substances go to tab "Downloads", Category "Manufacturer's declaration"

Drawings

Dimensional drawing

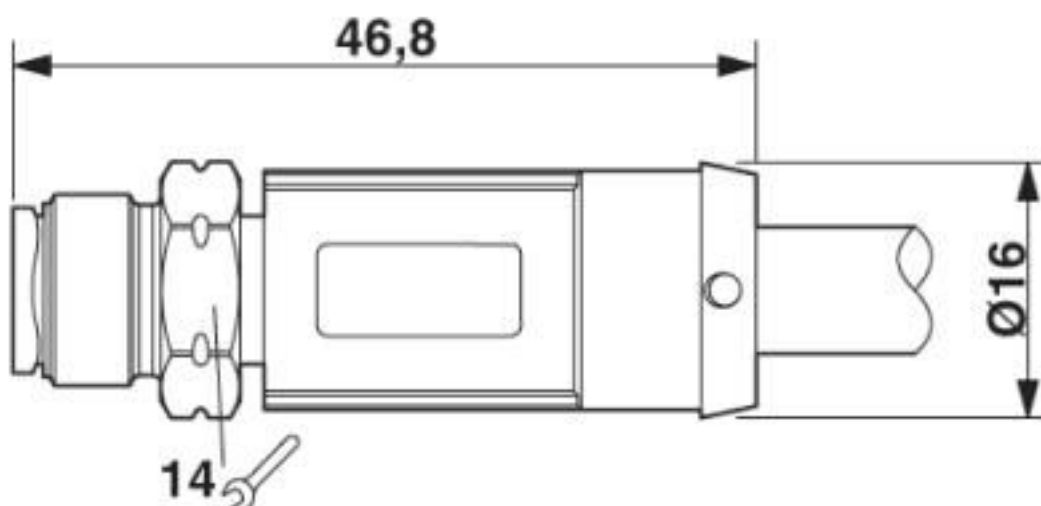

Plug, M12 x 1, straight, shielded

Bus system cable - SAC-4P-M12MS/15,0-960/M12FS VA - 1431319

Dimensional drawing

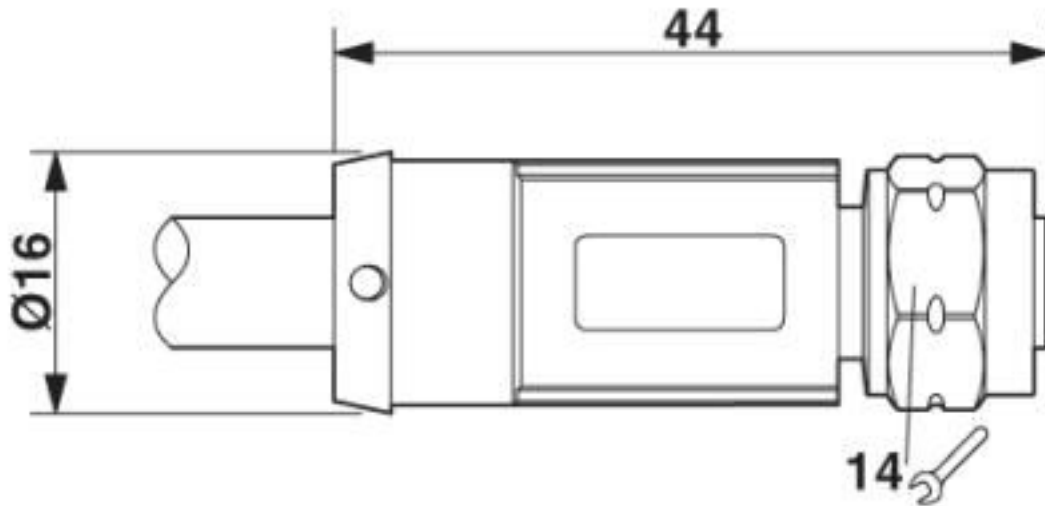

M12 x 1 socket, straight

Circuit diagram

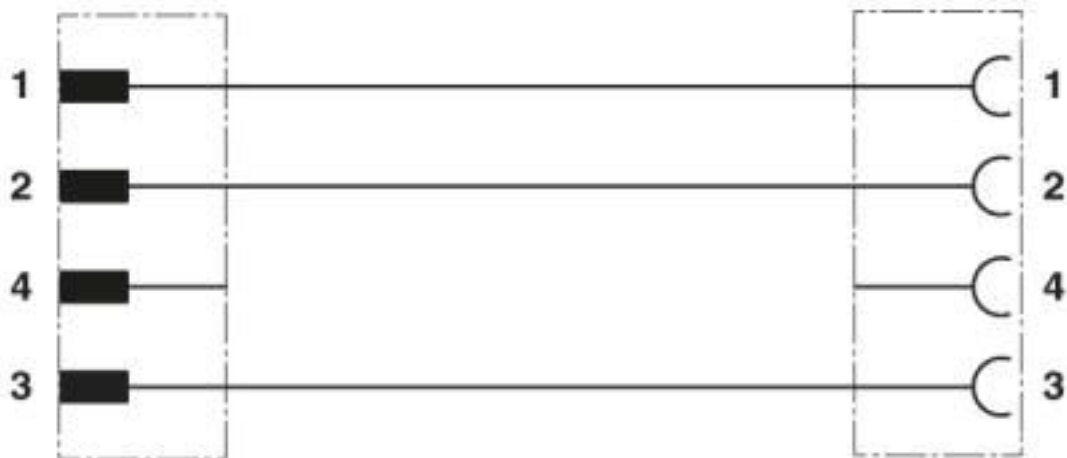

Contact assignment of the M12 connector and the M12 socket

Bus system cable - SAC-4P-M12MS/15,0-960/M12FS VA - 1431319

Schematic diagram



Pin assignment M12 plug, 4-pos., A-coded, view plug side

Bus system cable - SAC-4P-M12MS/15,0-960/M12FS VA - 1431319

Schematic diagram

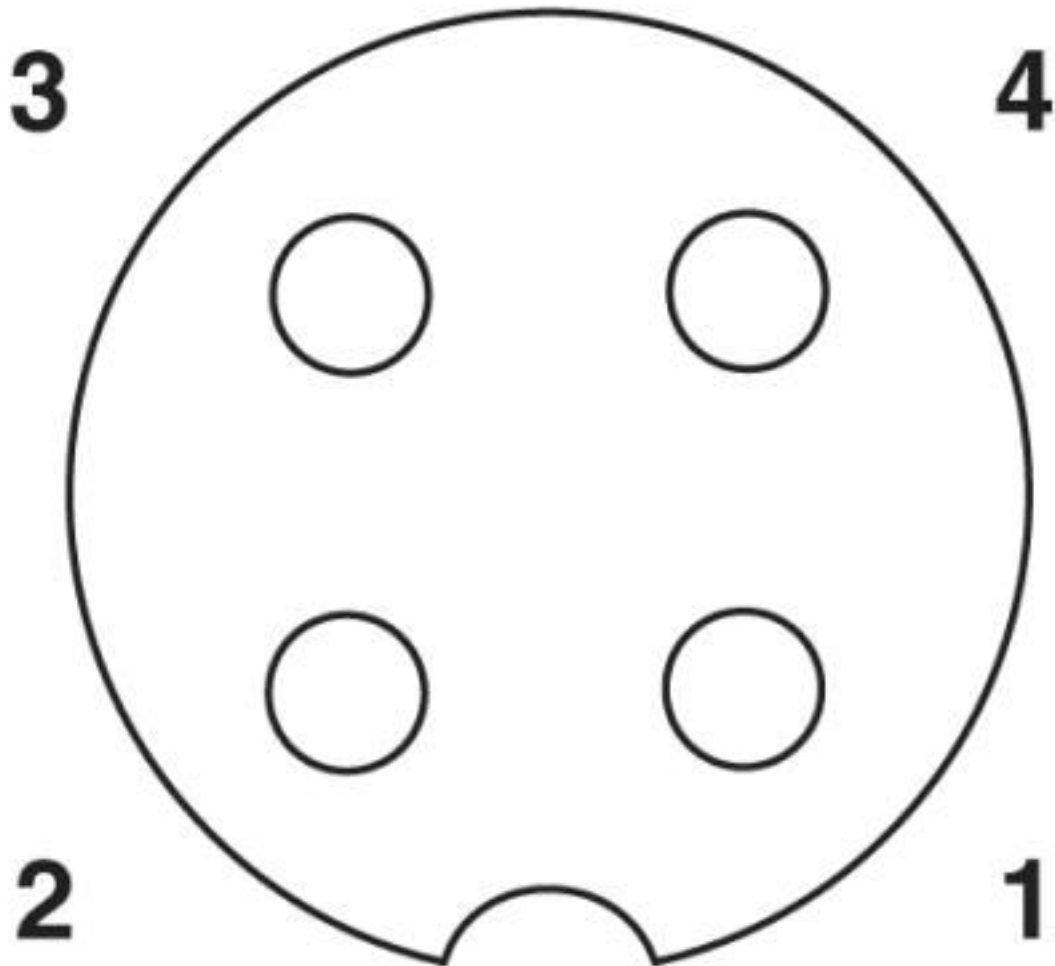

Pin assignment M12 socket, 4-pos., A-coded, view female side

Bus system cable - SAC-4P-M12MS/15,0-960/M12FS VA - 1431319

Cable cross section

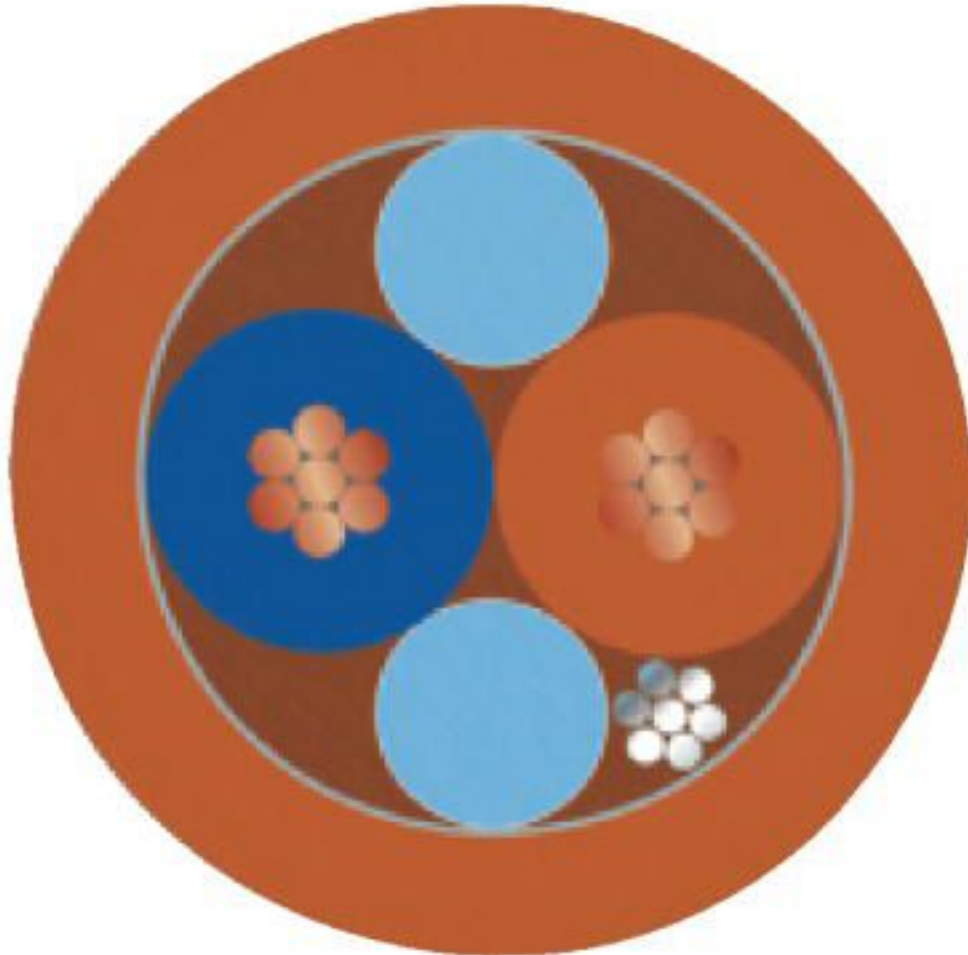

FOUNDATION Fieldbus orange [960]

Classifications

eCl@ss

eCl@ss 10.0.1	27060308
eCl@ss 4.0	27060300
eCl@ss 4.1	27060300
eCl@ss 5.0	27061800
eCl@ss 5.1	27061800
eCl@ss 6.0	27279200
eCl@ss 7.0	27279218
eCl@ss 8.0	27279218
eCl@ss 9.0	27060308

Bus system cable - SAC-4P-M12MS/15,0-960/M12FS VA - 1431319

Classifications

ETIM

ETIM 3.0	EC001855
ETIM 4.0	EC001855
ETIM 5.0	EC002599
ETIM 6.0	EC001262
ETIM 7.0	EC001262

UNSPSC

UNSPSC 6.01	31251501
UNSPSC 7.0901	31251501
UNSPSC 11	31251501
UNSPSC 12.01	31251501
UNSPSC 13.2	31251501
UNSPSC 18.0	26121604
UNSPSC 19.0	26121604
UNSPSC 20.0	26121604
UNSPSC 21.0	26121604

Approvals

Approvals

Approvals

EAC-RoHS / EAC

Ex Approvals

Approval details

EAC-RoHS		RU D- DE.HB35.B.00387
----------	--	--------------------------

EAC		RU C- DE.BL08.B.00286
-----	--	--------------------------

Accessories

Accessories

Data cable preassembled

Bus system cable - SAC-4P-M12MS/15,0-960/M12FS VA - 1431319

Accessories

Bus system cable - SAC-4P-M12MS FF VA/.../... - 1431322



Bus system cable, FOUNDATION Fieldbus (31.25 kbps), 3-position, Variable cable type, shielded, Plug straight M12, coding: A, on free cable end, cable length: Free input (0.2 ... 40.0 m), High-grade steel knurl

Bus system cable - SAC-4P-M12MR FF VA/.../... - 1431335



Bus system cable, FOUNDATION Fieldbus (31.25 kbps), 3-position, Variable cable type, shielded, Plug angled M12, coding: A, on free cable end, cable length: Free input (0.2 ... 40.0 m), High-grade steel knurl

Bus system cable - SAC-4P-M12FS FF VA/.../... - 1431348



Bus system cable, FOUNDATION Fieldbus (31.25 kbps), 3-position, Variable cable type, shielded, free cable end, on Socket straight M12, coding: A, cable length: Free input (0.2 ... 40.0 m), High-grade steel knurl

Bus system cable - SAC-4P-M12FR FF VA/.../... - 1431351



Bus system cable, FOUNDATION Fieldbus (31.25 kbps), 3-position, Variable cable type, shielded, free cable end, on Socket angled M12, coding: A, cable length: Free input (0.2 ... 40.0 m), High-grade steel knurl

Bus system cable - SAC-4P-M12MS-M12FS FF VA/... - 1431364



Bus system cable, FOUNDATION Fieldbus (31.25 kbps), 3-position, Variable cable type, shielded, Plug straight M12, coding: A, on Socket straight M12, coding: A, cable length: Free input (0.2 ... 40.0 m), High-grade steel knurl

Bus system cable - SAC-4P-M12MS/15,0-960/M12FS VA - 1431319

Accessories

Bus system cable - SAC-4P-M12MS-M12FR FF VA/... - 1431380



Bus system cable, FOUNDATION Fieldbus (31.25 kbps), 3-position, Variable cable type, shielded, Plug straight M12, coding: A, on Socket angled M12, coding: A, cable length: Free input (0.2 ... 40.0 m), High-grade steel knurl

Bus system cable - SAC-4P-M12MR-M12FS FF VA/... - 1431377



Bus system cable, FOUNDATION Fieldbus (31.25 kbps), 3-position, Variable cable type, shielded, Plug angled M12, coding: A, on Socket straight M12, coding: A, cable length: Free input (0.2 ... 40.0 m), High-grade steel knurl

Bus system cable - SAC-4P-M12MR-M12FR FF VA/... - 1431393



Bus system cable, FOUNDATION Fieldbus (31.25 kbps), 3-position, Variable cable type, shielded, Plug angled M12, coding: A, on Socket angled M12, coding: A, cable length: Free input (0.2 ... 40.0 m), High-grade steel knurl

Plug for cable screw gland

Screw plug - PROT-M12 MS-PA-CHAIN - 1430899

M12 sealing cap with fixing band, for sensor cables, for free M12 sockets



Protective cap

Sealing cap - PROT-M12 FS-PA-CHAIN - 1430873

M12 sealing cap made of plastic with fixing band, for sensor cables, for free M12 plugs



Screwdriver tools

Bus system cable - SAC-4P-M12MS/15,0-960/M12FS VA - 1431319

Accessories

Adapter insert - TSD-M SAC-BIT ADAPTER - 1212600



Adapter bit for TSD-M...torque tools, E6.3-1/4" drive with 4 mm hexagon to accommodate SAC bits

Adapter - SAC BIT M12-W14 - 1212513



Nut for assembling sensor/actuator cables with M12 connector and M12 connectors for assembly, with a hexagonal knurl wrench size of 14 mm, with 4 mm hexagonal drive

T-distributor

T distributor - SAC-4P-M12T/2XM12 FF VA - 1431416



T distributor, FOUNDATION Fieldbus, FOUNDATION Fieldbus, 4-position, unshielded, Plug straight M12, coding: A, on Socket straight M12, coding: A and Socket straight M12, coding: A, Parallel distributor

Terminal resistor

Termination resistor - SAC-4P-M12MS FF TR VA - 1431403



FOUNDATION Fieldbus™ termination resistor, 4-pos., M12 connector, high-grade steel knurl

Torque tool

Torque screwdriver - TSD 04 SAC - 1208429



Torque screwdriver, with preset torque of 0.4 Nm and 4 mm hexagonal drive for M12 connectors

Bus system cable - SAC-4P-M12MS/15,0-960/M12FS VA - 1431319

Accessories

Torque screwdriver - TSD-M 1,2NM - 1212224



Torque screw driver, accuracy as per EN ISO 6789 standard, adjustable from 0.3 - 1.2 Nm

Phoenix Contact 2020 © - all rights reserved
<http://www.phoenixcontact.com>

PHOENIX CONTACT GmbH & Co. KG
Flachsmarktstr. 8
32825 Blomberg
Germany
Tel. +49 5235 300
Fax +49 5235 3 41200
<http://www.phoenixcontact.com>

X-ON Electronics

Largest Supplier of Electrical and Electronic Components

Click to view similar products for [Sensor Cables / Actuator Cables](#) category:

Click to view products by [Phoenix Contact](#) manufacturer:

Other Similar products are found below :

[60963](#) [60964](#) [703000D02F2002](#) [703001D02F0602](#) [703001D02F300](#) [704000D02F120](#) [773032K02F030](#) [802027107404-1](#) [802027213811-1](#)
[804001A09M150](#) [805001A09M0502](#) [84914-0235](#) [84914-0237](#) [885030A09M020](#) [8R4J30E03C3003](#) [1200651332](#) [1200651713](#) [1200660844](#)
[1200660845](#) [1200661173](#) [1200680071](#) [1200720053](#) [1200720081](#) [1200720099](#) [1200720217](#) [1200800231](#) [1200860125](#) [1200870123](#)
[1200980102](#) [1200650267](#) [1200650298](#) [1200660183](#) [1200660782](#) [1200660849](#) [1200661295](#) [1200661297](#) [1200661342](#) [1200661343](#)
[1200670080](#) [1200670220](#) [1200680331](#) [1200720252](#) [1200730184](#) [1200860344](#) [1200870359](#) [1200870643](#) [1200980008](#) [1200980031](#)
[1210502211](#) [1210400542](#)