

## Sensor/actuator cable - SAC-3P-MS/ 0,6-PUR/B-1L-Z SCO - 1435292

Please be informed that the data shown in this PDF Document is generated from our Online Catalog. Please find the complete data in the user's documentation. Our General Terms of Use for Downloads are valid (<http://phoenixcontact.com/download>)



Sensor/actuator cable, 3-position, PUR halogen-free, black-gray RAL 7021, Plug straight M12 SPEEDCON, coding: A, on Valve connector B (10 mm), with 1 LED, connected with Z diode, cable length: 0.6 m

### Your advantages

- ✓ Easy and safe: 100% electrically tested plug-in components
- ✓ Robust valve connector with Zener diode as protective circuit
- ✓ Save time, thanks to installation with SPEEDCON fast locking system
- ✓ Convenient: increased machine availability thanks to quick and easy diagnostics
- ✓ Our standard: robust halogen-free PUR cable



### Key Commercial Data

|              |   |
|--------------|---|
| Packing unit | 1 pc  |
| GTIN         | <br>4 046356 413619 |
| GTIN         | 4046356413619   |

### Technical data

#### Dimensions

|                               |         |
|-------------------------------|---------|
| Length of cable               | 0.6 m   |
| Central screw valve connector | M3 x 29 |

#### Ambient conditions

|                                 |                                  |
|---------------------------------|----------------------------------|
| Ambient temperature (operation) | -25 °C ... 90 °C (Plug / socket) |
|                                 | -20 °C ... 85 °C (valve plug)    |
| Degree of protection            | IP65                             |
|                                 | IP67                             |

#### General

|                       |         |
|-----------------------|---------|
| Rated current at 40°C | 4 A     |
| Rated voltage         | 24 V AC |
|                       | 24 V DC |

# Sensor/actuator cable - SAC-3P-MS/ 0,6-PUR/B-1L-Z SCO - 1435292

## Technical data

### General

|                              |                                    |
|------------------------------|------------------------------------|
| Number of positions          | 3                                  |
| Insulation resistance        | ≥ 100 MΩ                           |
| Coding                       | A - standard                       |
| Standards/regulations        | M12 connector IEC 61076-2-101      |
|                              | Valve connector EN 175301-803      |
| Status display               | 1 LED                              |
| Protective circuit/component | Z diode                            |
| Pulse power $W_{max}$        | 40 W (at 100 μs square-wave pulse) |
| Terminal voltage             | 70 V (at 2 mA constant current)    |
| Reverse voltage              | 50 V                               |
| Overvoltage category         | III                                |
| Degree of pollution          | 3                                  |
| Insertion/withdrawal cycles  | ≥ 100 (M12 connector)              |
| Torque                       | 0.4 Nm (M12 connector)             |
|                              | 0.6 Nm (Valve connector)           |

### Material

|  |                              |
|--|------------------------------|
| Flammability rating according to UL 94 | HB                           |
| Contact material                       | CuSn                         |
| Contact surface material               | Ni/Au                        |
| Contact carrier material               | TPU GF                       |
| Material of grip body                  | TPU                          |
| Valve plug contact material            | CuSn                         |
| Valve plug contact surface material    | Sn                           |
| Valve plug contact insert material     | PA 6.6                       |
| Material housing valve plug            | TPU                          |
| Material, knurls                       | Zinc die-cast, nickel-plated |
| Sealing material                       | TPU (Seal molded)            |

### Standards and Regulations

|  |                               |
|--|-------------------------------|
| Standards/specifications               | M12 connector IEC 61076-2-101 |
|  | Valve connector EN 175301-803 |
| Flammability rating according to UL 94 | HB                            |

### Cable

|                                 |                        |
|---------------------------------|------------------------|
| Cable type                      | PUR halogen-free black |
| Cable type (abbreviation)       | PUR                    |
| Cable abbreviation              | Li9Y11Y-HF             |
| UL AWM style                    | 20549                  |
| Conductor cross section         | 3x 0.5 mm <sup>2</sup> |
| AWG signal line                 | 20                     |
| Conductor structure signal line | 28x 0.15 mm            |

## Sensor/actuator cable - SAC-3P-MS/ 0,6-PUR/B-1L-Z SCO - 1435292

### Technical data

#### Cable

|   |  |
|---|--|
| Core diameter including insulation          | 1.5 mm ±0.05 mm (Signal line)                              |
| Wire colors                                 | black 1, black 2, green/yellow                             |
| Overall twist                               | 3 wires, twisted   |
| External sheath, color                      | black-gray RAL 7021  |
| External cable diameter D                   | 4.5 mm ±0.2 mm   |
| Smallest bending radius, fixed installation | 22.5 mm  |
| Number of bending cycles                    | 15000000   |
| Bending radius                              | 50 mm  |
| Traversing path                             | 0.9 m  |
| Traversing rate                             | 5 m/s  |
| Acceleration                                | 30 m/s <sup>2</sup>  |
| Outer sheath, material                      | PUR  |
| Material conductor insulation               | PP   |
| Conductor material                          | Bare Cu litz wires   |
| Insulation resistance                       | min. 20 MΩ*km  |
| Conductor resistance                        | 39 Ω/km (at 20 °C)   |
| Nominal voltage, cable                      | ≤ 300 V  |
| Test voltage, cable                         | ≥ 1200 V   |
| Flame resistance                            | according to DIN VDE 0482                                  |
|   | According to DIN EN 50265-2-1                              |
| Halogen-free                                | in accordance with DIN VDE 0472 part 815                   |
| Other resistance                            | largely oil-resistant                                      |
|   | partly UV-resistant in accordance with DIN EN ISO 4892-2-A |
| Ambient temperature (operation)             | -40 °C ... 80 °C (cable, fixed installation)               |
|   | -20 °C ... 80 °C (cable, flexible installation)            |

#### Environmental Product Compliance

|            |   |
|------------|---|
| China RoHS | Environmentally Friendly Use Period = 50 years  |
|            | For details about hazardous substances go to tab "Downloads", Category "Manufacturer's declaration" |

#### Drawings

# Sensor/actuator cable - SAC-3P-MS/ 0,6-PUR/B-1L-Z SCO - 1435292

Dimensional drawing



Plug, M12 x 1, straight, shielded

Dimensional drawing

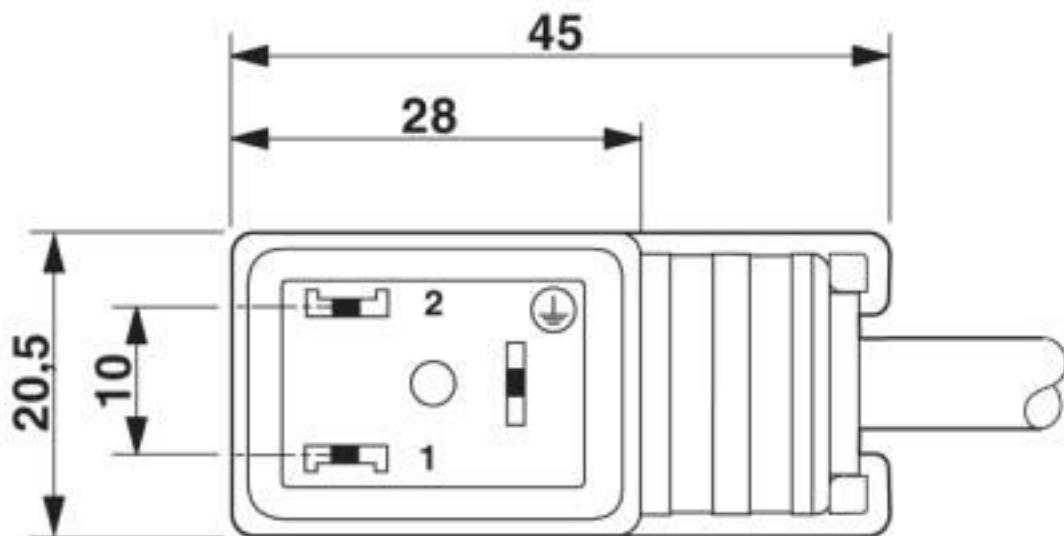

Valve connector, type B

# Sensor/actuator cable - SAC-3P-MS/ 0,6-PUR/B-1L-Z SCO - 1435292

Dimensional drawing

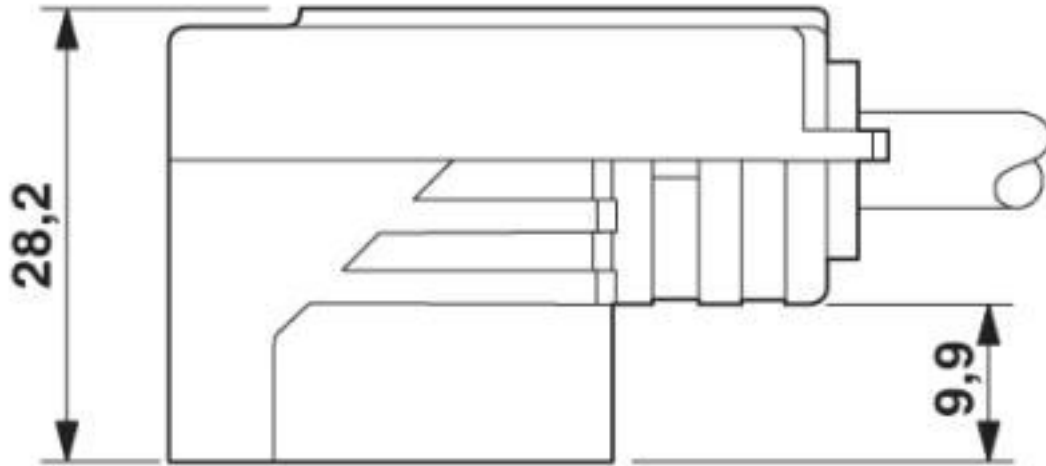

Valve connector, type B, side view

Circuit diagram

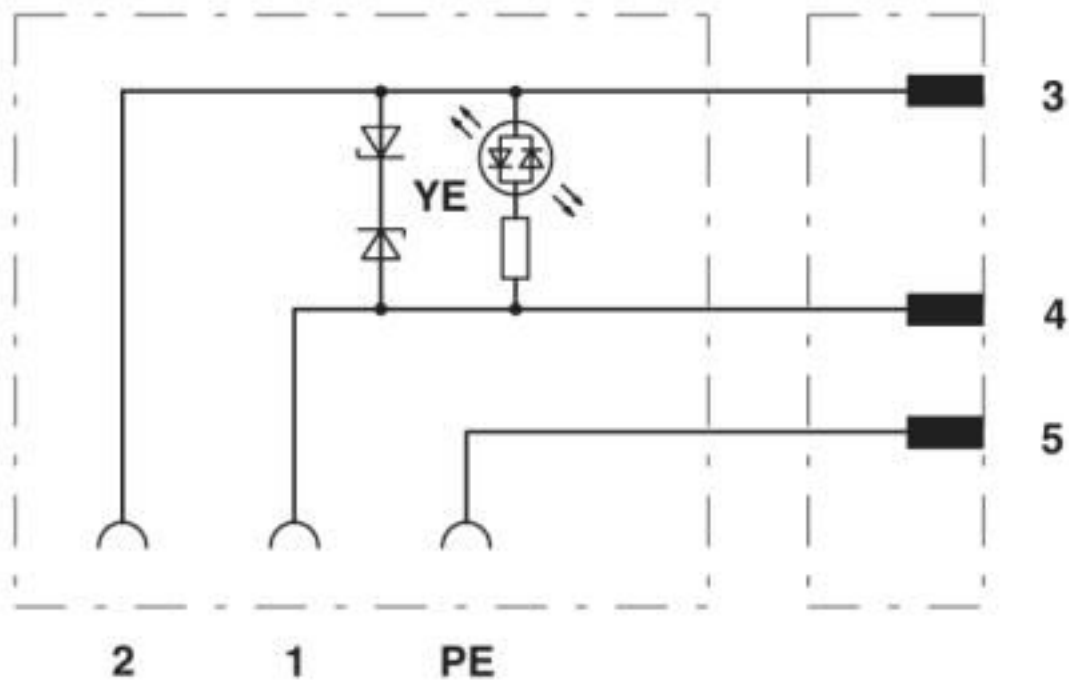

Contact assignment of M12 plug and valve connector

## Sensor/actuator cable - SAC-3P-MS/ 0,6-PUR/B-1L-Z SCO - 1435292

Schematic diagram

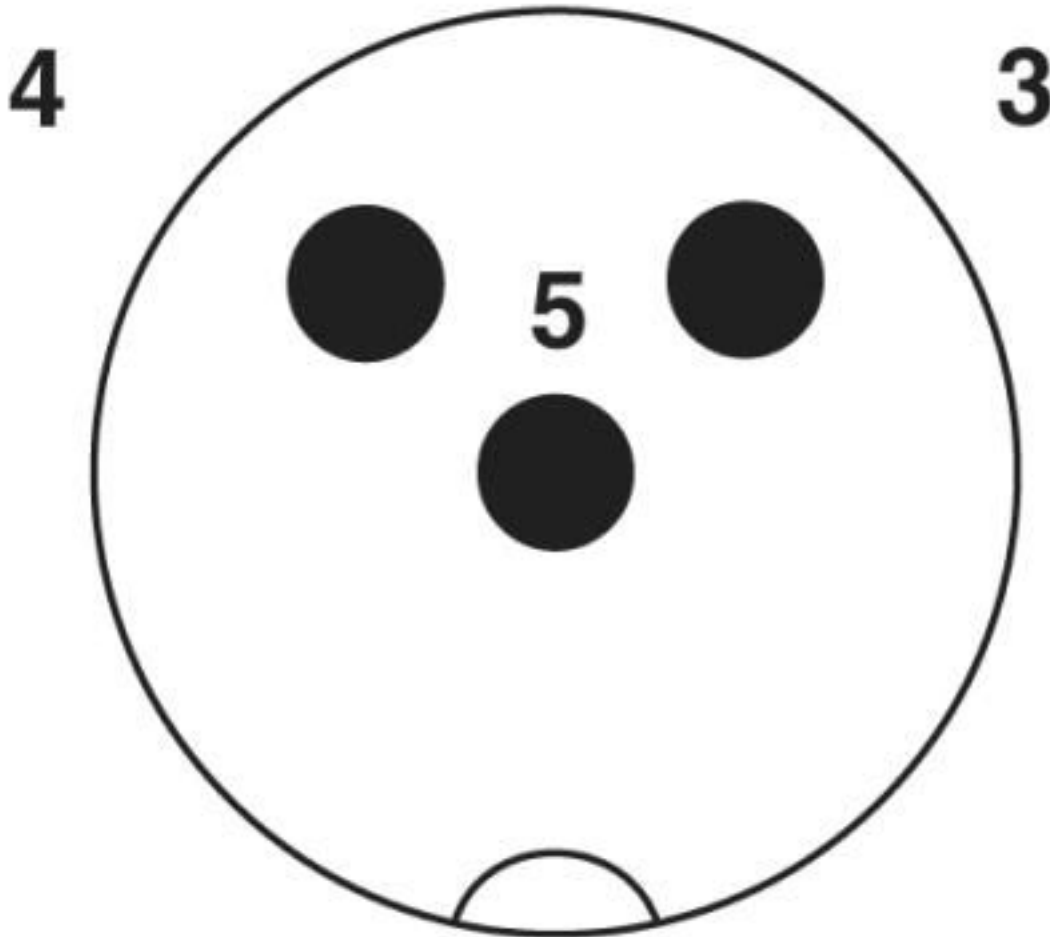

Pin assignment M12 plug, 3-pos., valve connector

# Sensor/actuator cable - SAC-3P-MS/ 0,6-PUR/B-1L-Z SCO - 1435292

Cable cross section

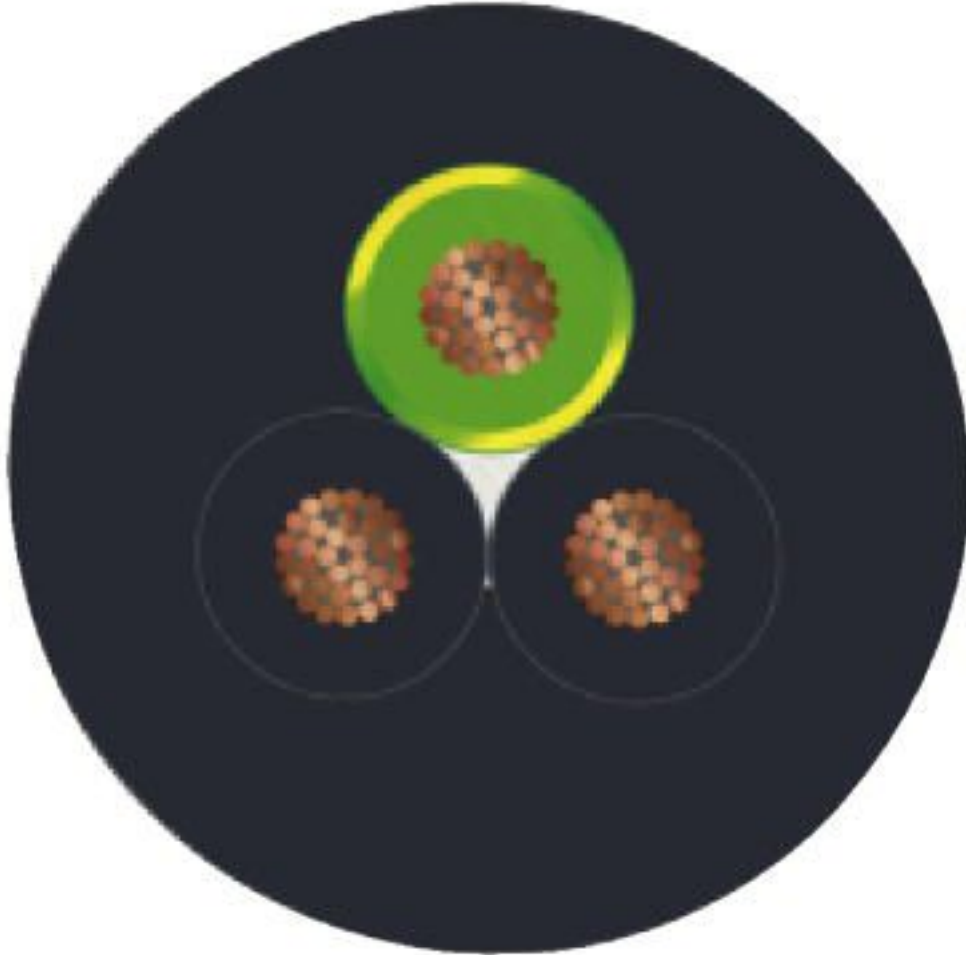

PUR halogen-free black [PUR]

## Classifications

eCl@ss

|               |          |
|---------------|----------|
| eCl@ss 10.0.1 | 27060312 |
| eCl@ss 4.0    | 27060300 |
| eCl@ss 4.1    | 27060300 |
| eCl@ss 5.0    | 27061800 |
| eCl@ss 5.1    | 27061800 |
| eCl@ss 6.0    | 27279200 |
| eCl@ss 7.0    | 27279218 |
| eCl@ss 8.0    | 27279218 |
| eCl@ss 9.0    | 27060312 |

# Sensor/actuator cable - SAC-3P-MS/ 0,6-PUR/B-1L-Z SCO - 1435292

## Classifications

### ETIM

|          |          |
|----------|----------|
| ETIM 3.0 | EC001855 |
| ETIM 4.0 | EC001855 |
| ETIM 5.0 | EC001855 |
| ETIM 6.0 | EC001855 |
| ETIM 7.0 | EC001855 |

### UNSPSC

|               |          |
|---------------|----------|
| UNSPSC 6.01   | 31251501 |
| UNSPSC 7.0901 | 31251501 |
| UNSPSC 11     | 31251501 |
| UNSPSC 12.01  | 31251501 |
| UNSPSC 13.2   | 31251501 |
| UNSPSC 19.0   | 31251501 |
| UNSPSC 20.0   | 31251501 |
| UNSPSC 21.0   | 31251501 |

## Approvals

### Approvals

Approvals

CSAus / EAC-RoHS / EAC

Ex Approvals

### Approval details

|                    |   |   |       |
|--------------------|---|---|-------|
| CSAus              |  | <a href="http://www.csagroup.org/services-industries/product-listing/">http://www.csagroup.org/services-industries/product-listing/</a> | 13631 |
| Nominal voltage UN | 24 V  |   |       |
| Nominal current IN | 4 A   |   |       |

|          |   |                      |
|----------|---|----------------------|
| EAC-RoHS |  | RU D-DE.HB35.B.00387 |
|----------|---|----------------------|



## Sensor/actuator cable - SAC-3P-MS/ 0,6-PUR/B-1L-Z SCO - 1435292

### Approvals

EAC



RU C-  
DE.BL08.B.00286

### Accessories

#### Accessories

#### Conductor marking

Insert label - PABA WH/23 - 1013779



Insert label, Strip, white, unlabeled, can be labeled with: CMS-P1-PLOTTER, mounting type: thread on, cable diameter range: 1.5 ... 35 mm, lettering field size: 23 x 4 mm, Number of individual labels: 20

Insert label - PABA YE/23 - 1013782



Insert label, Strip, yellow, unlabeled, can be labeled with: CMS-P1-PLOTTER, mounting type: thread on, cable diameter range: 1.5 ... 35 mm, lettering field size: 23 x 4 mm, Number of individual labels: 20

#### Marker pen

Marker pen - B-STIFT - 1051993



Marker pen, for manual labeling of unprinted Zack strips, smear-proof and waterproof, line thickness 0.5 mm

#### Mounting material

Screw - SAC-V-SCREW-M3-29 KNURL - 1403779



Fillister head screw with plastic knurl, M3 x 40

#### Protective cap

## Sensor/actuator cable - SAC-3P-MS/ 0,6-PUR/B-1L-Z SCO - 1435292

### Accessories

Sealing cap - PROT-M12 FS-PA-CHAIN - 1430873

M12 sealing cap made of plastic with fixing band, for sensor cables, for free M12 plugs



---

### Safety locking

Locking clip - SAC-M12-EXCLIP-M - 1558988



Locking clip for the pin side of sensor/actuator cables with M12 connector and M12 connectors for assembly, for knurl diameter: 15 mm or for Allen key with a wrench size of 14 mm, prevents the disconnection of plug-in connections without tools

---

### Screwdriver tools

Screw insert - SF-BIT-PH 1-70 - 1212582



Screw bit, PH crosshead, E6.3-1/4" drive, size: PH 1 x 70 mm, hardened, suitable for holder according to DIN 3126-F6.3/ISO 1173

---

Adapter insert - TSD-M SAC-BIT ADAPTER - 1212600



Adapter bit for TSD-M...torque tools, E6.3-1/4" drive with 4 mm hexagon to accommodate SAC bits

---

Tool - SAC BIT M12-D15 - 1208432



Nut for assembling sensor/actuator cables with M12 connector and M12 connectors for assembly, with a knurl diameter of 15 mm, for 4 mm hexagonal drive

---

### Torque tool

## Sensor/actuator cable - SAC-3P-MS/ 0,6-PUR/B-1L-Z SCO - 1435292

### Accessories

Torque screwdriver - TSD 04 SAC - 1208429



Torque screwdriver, with preset torque of 0.4 Nm and 4 mm hexagonal drive for M12 connectors

---

Torque screwdriver - TSD-M 1,2NM - 1212224



Torque screw driver, accuracy as per EN ISO 6789 standard, adjustable from 0.3 - 1.2 Nm

---

---

Phoenix Contact 2020 © - all rights reserved  
<http://www.phoenixcontact.com>

PHOENIX CONTACT GmbH & Co. KG  
Flachsmarktstr. 8  
32825 Blomberg  
Germany  
Tel. +49 5235 300  
Fax +49 5235 3 41200  
<http://www.phoenixcontact.com>

## X-ON Electronics

Largest Supplier of Electrical and Electronic Components

*Click to view similar products for [Sensor Cables / Actuator Cables](#) category:*

*Click to view products by [Phoenix Contact](#) manufacturer:*

Other Similar products are found below :

[60963](#) [60964](#) [703000D02F2002](#) [703001D02F0602](#) [703001D02F300](#) [704000D02F120](#) [773032K02F030](#) [802027107404-1](#) [802027213811-1](#)  
[804001A09M150](#) [805001A09M0502](#) [84914-0235](#) [84914-0237](#) [885030A09M020](#) [8R4J30E03C3003](#) [1200651332](#) [1200651713](#) [1200660844](#)  
[1200660845](#) [1200661173](#) [1200680071](#) [1200720053](#) [1200720081](#) [1200720099](#) [1200720217](#) [1200800231](#) [1200860125](#) [1200870123](#)  
[1200980102](#) [1200650267](#) [1200650298](#) [1200660183](#) [1200660782](#) [1200660849](#) [1200661295](#) [1200661297](#) [1200661342](#) [1200661343](#)  
[1200670080](#) [1200670220](#) [1200680331](#) [1200720252](#) [1200730184](#) [1200860344](#) [1200870359](#) [1200870643](#) [1200980008](#) [1200980031](#)  
[1210502211](#) [1210400542](#)