

Sensor/actuator cable - SAC-3P-MS/ 3,0-PUR/C-1L-Z SCO - 1435467

Please be informed that the data shown in this PDF Document is generated from our Online Catalog. Please find the complete data in the user's documentation. Our General Terms of Use for Downloads are valid (<http://phoenixcontact.com/download>)



Sensor/actuator cable, 3-position, PUR halogen-free, black-gray RAL 7021, Plug straight M12 SPEEDCON, coding: A, on Valve connector C (8 mm), with 1 LED, connected with Z diode, cable length: 3 m

Your advantages

- ✓ Easy and safe: 100% electrically tested plug-in components
- ✓ Robust valve connector with Zener diode as protective circuit
- ✓ Save time, thanks to installation with SPEEDCON fast locking system
- ✓ Convenient: increased machine availability thanks to quick and easy diagnostics
- ✓ Our standard: robust halogen-free PUR cable



Key Commercial Data

Packing unit	1 pc
GTIN	 4 046356 413756
GTIN	4046356413756

Technical data

Dimensions

Length of cable	3 m
Central screw valve connector	M2,5 x 27,5

Ambient conditions

Ambient temperature (operation)	-25 °C ... 90 °C (Plug / socket)
	-20 °C ... 85 °C (valve plug)
Degree of protection	IP65
	IP67

General

Rated current at 40°C	4 A
Rated voltage	24 V AC
	24 V DC

Sensor/actuator cable - SAC-3P-MS/ 3,0-PUR/C-1L-Z SCO - 1435467

Technical data

General

Number of positions	3
Insulation resistance	≥ 100 MΩ
Coding	A - standard
Standards/regulations	M12 connector IEC 61076-2-101
	Valve connector EN 175301-803
Status display	1 LED
Protective circuit/component	Z diode
Pulse power W_{max}	40 W (at 100 μs square-wave pulse)
Terminal voltage	70 V (at 2 mA constant current)
Reverse voltage	50 V
Overvoltage category	III
Degree of pollution	3
Insertion/withdrawal cycles	≥ 100 (M12 connector)
Torque	0.4 Nm (M12 connector)
	0.6 Nm (Valve connector)

Material

Flammability rating according to UL 94	HB
Contact material	CuSn
Contact surface material	Ni/Au
Contact carrier material	TPU GF
Material of grip body	TPU
Valve plug contact material	CuSn
Valve plug contact surface material	Sn
Valve plug contact insert material	PA 6.6
Material housing valve plug	TPU
Material, knurls	Zinc die-cast, nickel-plated
Sealing material	TPU (Seal molded)

Standards and Regulations

Standards/specifications	M12 connector IEC 61076-2-101
	Valve connector EN 175301-803
Flammability rating according to UL 94	HB

Cable

Cable type	PUR halogen-free black
Cable type (abbreviation)	PUR
Cable abbreviation	Li9Y11Y-HF
UL AWM style	20549
Conductor cross section	3x 0.5 mm ²
AWG signal line	20
Conductor structure signal line	28x 0.15 mm

Sensor/actuator cable - SAC-3P-MS/ 3,0-PUR/C-1L-Z SCO - 1435467

Technical data

Cable

Core diameter including insulation	1.5 mm ±0.05 mm (Signal line)
Wire colors	black 1, black 2, green/yellow
Overall twist	3 wires, twisted
External sheath, color	black-gray RAL 7021
External cable diameter D	4.5 mm ±0.2 mm
Smallest bending radius, fixed installation	22.5 mm
Number of bending cycles	15000000
Bending radius	50 mm
Traversing path	0.9 m
Traversing rate	5 m/s
Acceleration	30 m/s ²
Outer sheath, material	PUR
Material conductor insulation	PP
Conductor material	Bare Cu litz wires
Insulation resistance	min. 20 MΩ*km
Conductor resistance	39 Ω/km (at 20 °C)
Nominal voltage, cable	≤ 300 V
Test voltage, cable	≥ 1200 V
Flame resistance	according to DIN VDE 0482
	According to DIN EN 50265-2-1
Halogen-free	in accordance with DIN VDE 0472 part 815
Other resistance	largely oil-resistant
	partly UV-resistant in accordance with DIN EN ISO 4892-2-A
Ambient temperature (operation)	-40 °C ... 80 °C (cable, fixed installation)
	-20 °C ... 80 °C (cable, flexible installation)

Environmental Product Compliance

China RoHS	Environmentally Friendly Use Period = 50 years
	For details about hazardous substances go to tab "Downloads", Category "Manufacturer's declaration"

Drawings

Sensor/actuator cable - SAC-3P-MS/ 3,0-PUR/C-1L-Z SCO - 1435467

Dimensional drawing

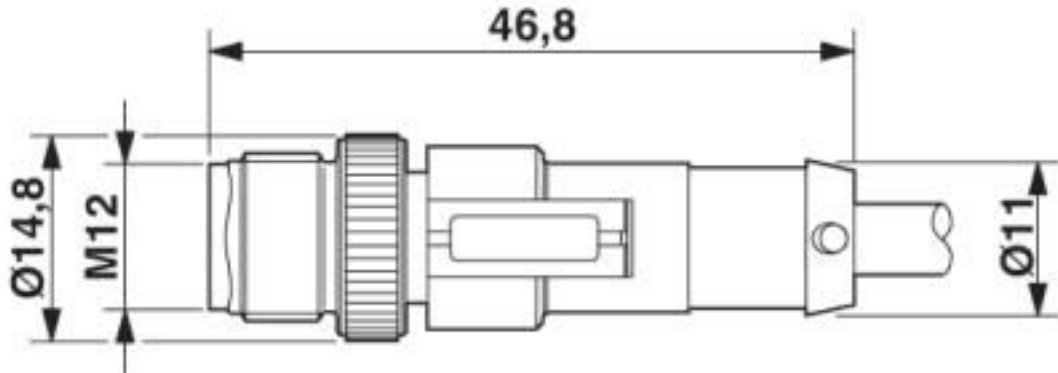

Plug, M12 x 1, straight, shielded

Dimensional drawing

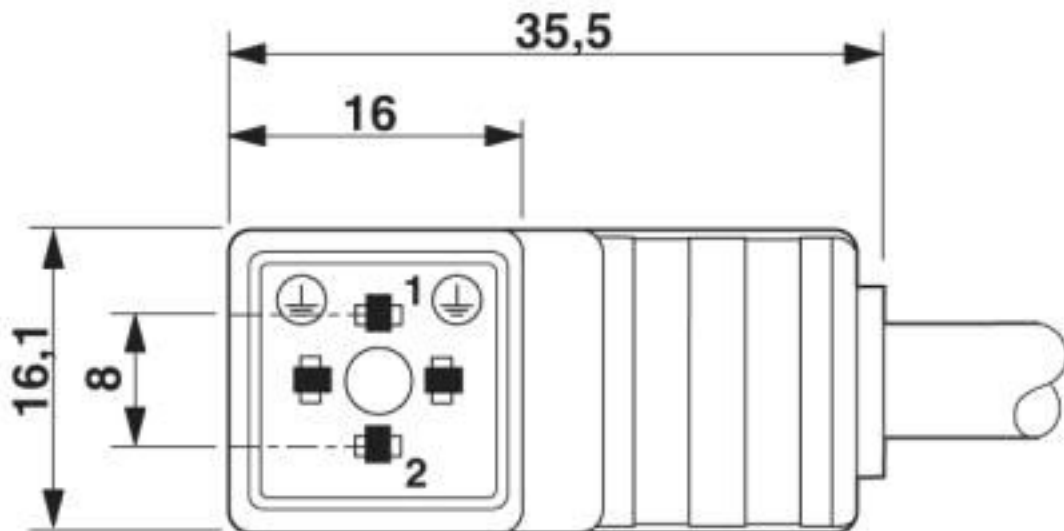

Valve connector, type C

Sensor/actuator cable - SAC-3P-MS/ 3,0-PUR/C-1L-Z SCO - 1435467

Dimensional drawing

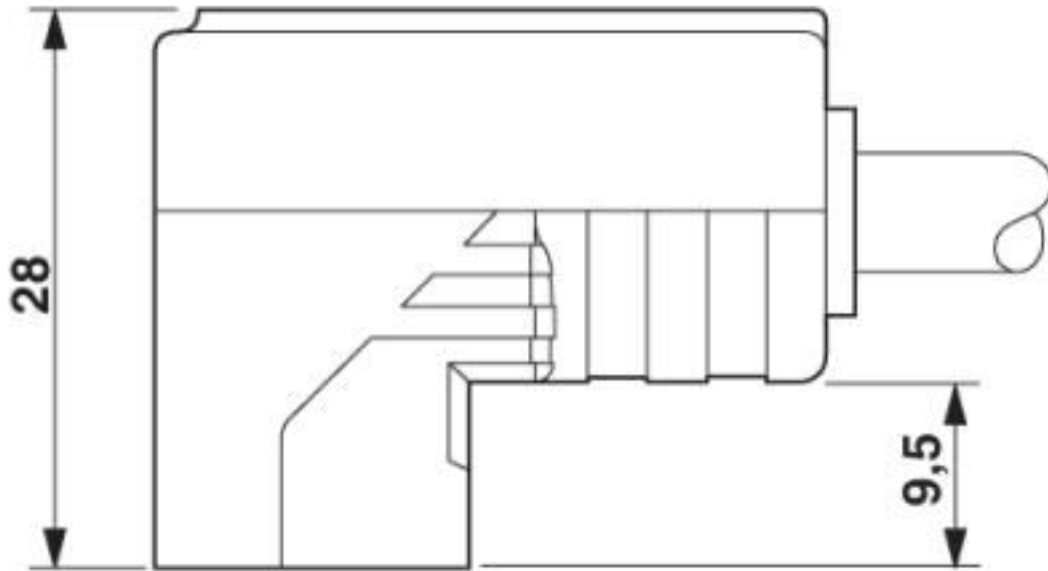

Valve connector, type C, side view

Circuit diagram

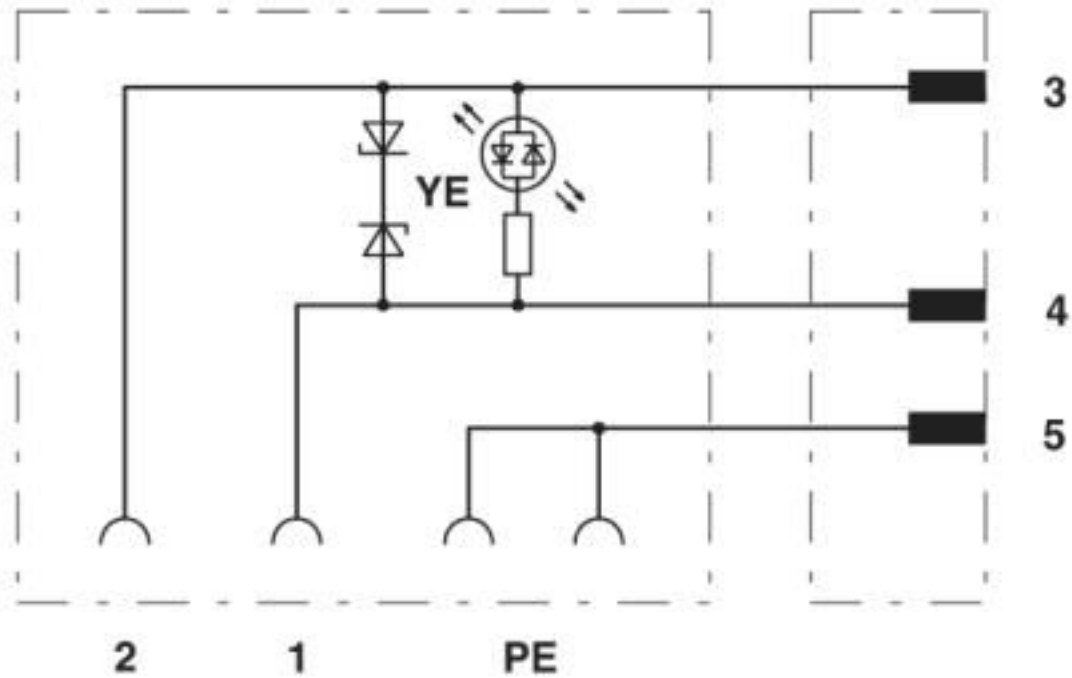

Contact assignment of M12 plug and valve connector

Sensor/actuator cable - SAC-3P-MS/ 3,0-PUR/C-1L-Z SCO - 1435467

Schematic diagram

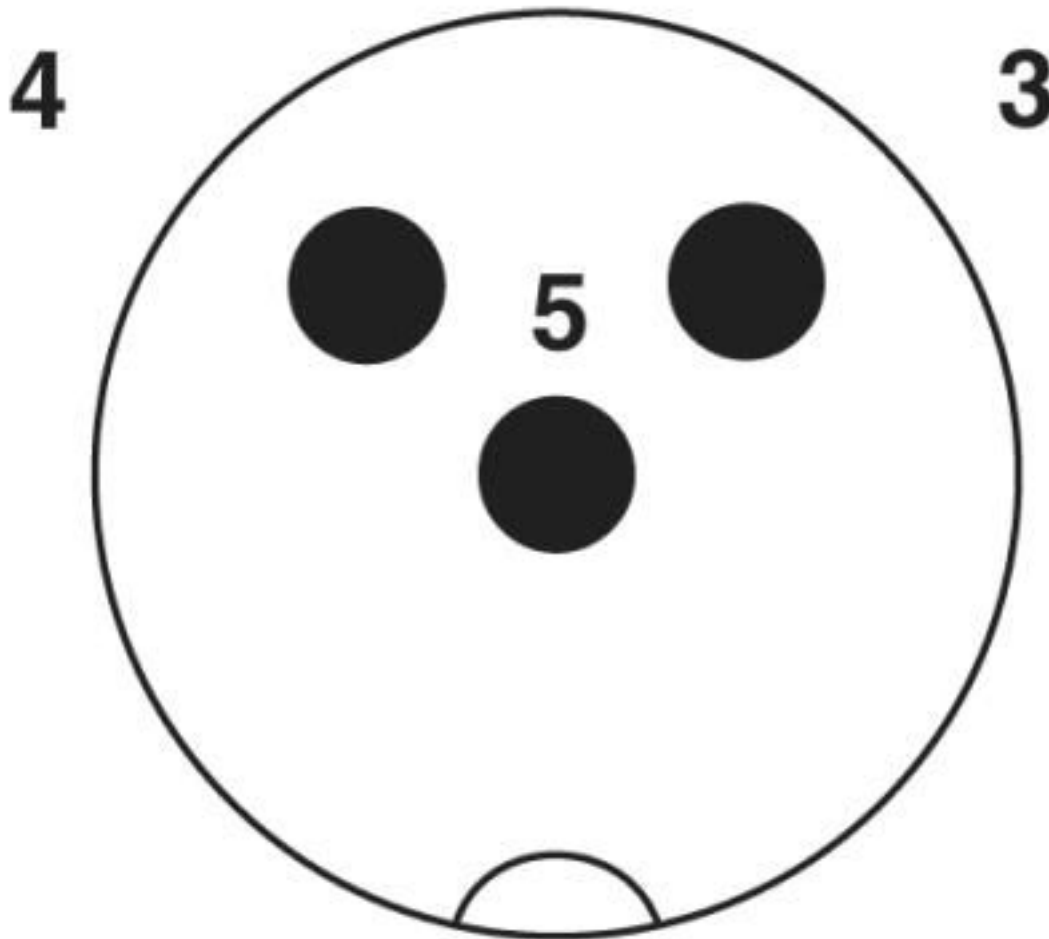

Pin assignment M12 plug, 3-pos., valve connector

Sensor/actuator cable - SAC-3P-MS/ 3,0-PUR/C-1L-Z SCO - 1435467

Schematic diagram

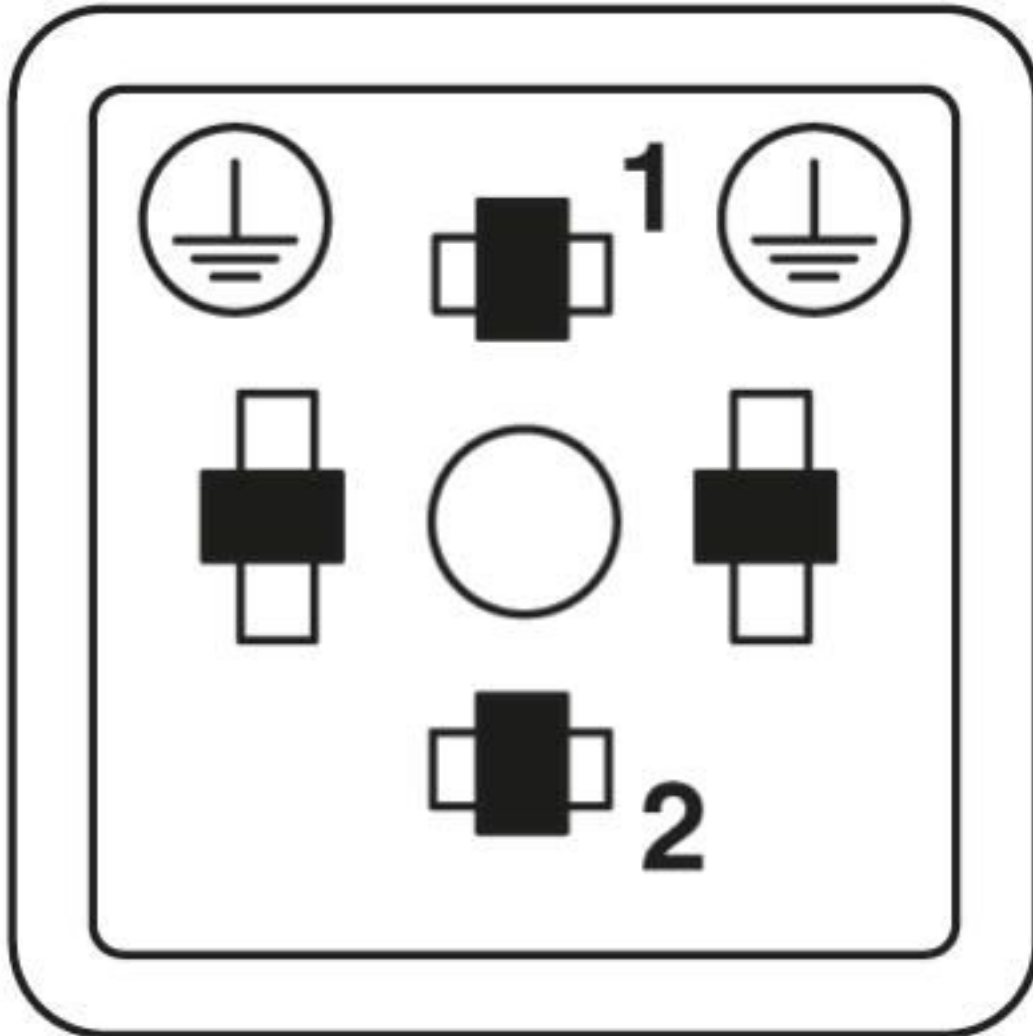

Valve connector connector pin assignment, type C

Sensor/actuator cable - SAC-3P-MS/ 3,0-PUR/C-1L-Z SCO - 1435467

Cable cross section

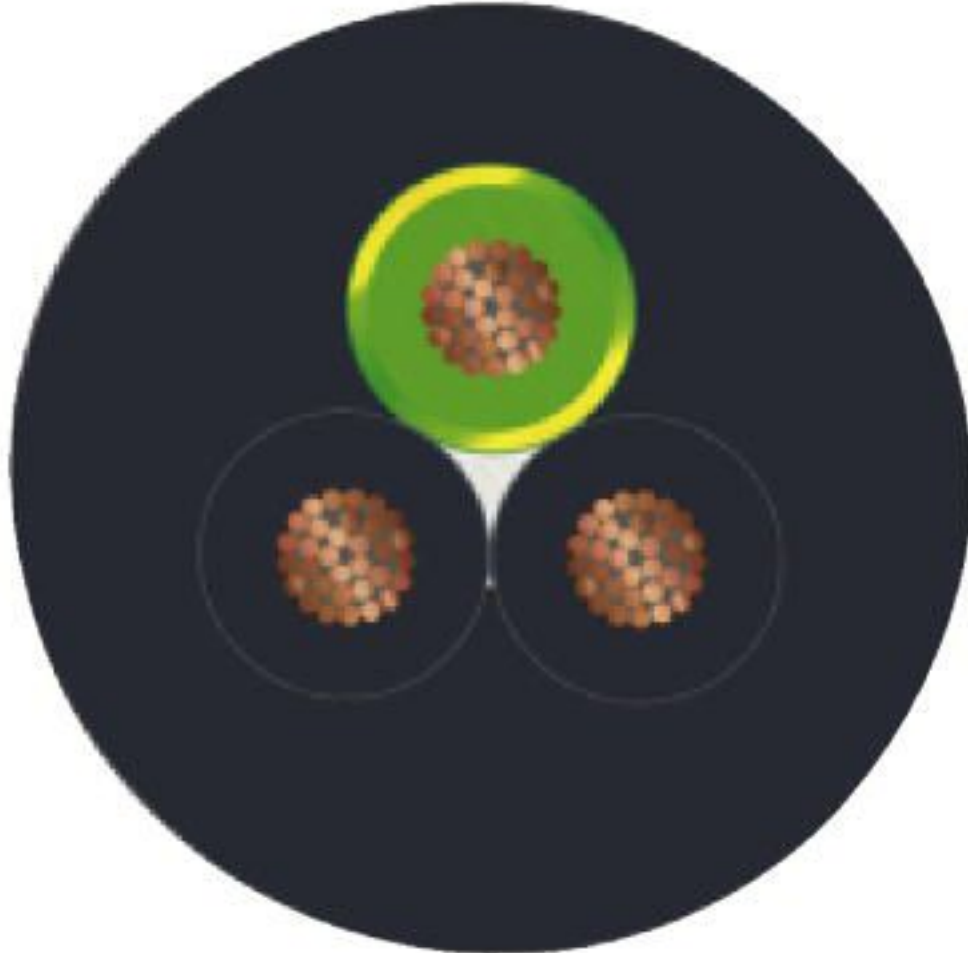

PUR halogen-free black [PUR]

Classifications

eCl@ss

eCl@ss 10.0.1	27060312
eCl@ss 4.0	27060300
eCl@ss 4.1	27060300
eCl@ss 5.0	27061800
eCl@ss 5.1	27061800
eCl@ss 6.0	27279200
eCl@ss 7.0	27279218
eCl@ss 8.0	27279218
eCl@ss 9.0	27060312

Sensor/actuator cable - SAC-3P-MS/ 3,0-PUR/C-1L-Z SCO - 1435467

Classifications

ETIM

ETIM 3.0	EC001855
ETIM 4.0	EC001855
ETIM 5.0	EC001855
ETIM 6.0	EC001855
ETIM 7.0	EC001855

UNSPSC

UNSPSC 6.01	31251501
UNSPSC 7.0901	31251501
UNSPSC 11	31251501
UNSPSC 12.01	31251501
UNSPSC 13.2	31251501
UNSPSC 19.0	31251501
UNSPSC 20.0	31251501
UNSPSC 21.0	31251501

Approvals

Approvals

Approvals

CSAus / EAC-RoHS / EAC

Ex Approvals

Approval details

CSAus		http://www.csagroup.org/services-industries/product-listing/	13631
Nominal voltage UN	24 V		
Nominal current IN	4 A		

EAC-RoHS		RU D-DE.HB35.B.00387
----------	---	----------------------

Sensor/actuator cable - SAC-3P-MS/ 3,0-PUR/C-1L-Z SCO - 1435467

Approvals

EAC		RU C- DE.BL08.B.00286
-----	--	--------------------------

Accessories

Accessories

Conductor marking

Insert label - PABA WH/23 - 1013779



Insert label, Strip, white, unlabeled, can be labeled with: CMS-P1-PLOTTER, mounting type: thread on, cable diameter range: 1.5 ... 35 mm, lettering field size: 23 x 4 mm, Number of individual labels: 20

Insert label - PABA YE/23 - 1013782



Insert label, Strip, yellow, unlabeled, can be labeled with: CMS-P1-PLOTTER, mounting type: thread on, cable diameter range: 1.5 ... 35 mm, lettering field size: 23 x 4 mm, Number of individual labels: 20

Marker pen

Marker pen - B-STIFT - 1051993



Marker pen, for manual labeling of unprinted Zack strips, smear-proof and waterproof, line thickness 0.5 mm

Protective cap

Sealing cap - PROT-M12 FS-PA-CHAIN - 1430873

M12 sealing cap made of plastic with fixing band, for sensor cables, for free M12 plugs



Safety locking

Sensor/actuator cable - SAC-3P-MS/ 3,0-PUR/C-1L-Z SCO - 1435467

Accessories

Locking clip - SAC-M12-EXCLIP-M - 1558988



Locking clip for the pin side of sensor/actuator cables with M12 connector and M12 connectors for assembly, for knurl diameter: 15 mm or for Allen key with a wrench size of 14 mm, prevents the disconnection of plug-in connections without tools

Screwdriver tools

Screw insert - SF-BIT-PH 2-70 - 1212583



Screw bit, PH crosshead, E6.3-1/4" drive, size: PH 2 x 70 mm, suitable for holder according to DIN 3126-F6.3/ISO 1173

Adapter insert - TSD-M SAC-BIT ADAPTER - 1212600



Adapter bit for TSD-M...torque tools, E6.3-1/4" drive with 4 mm hexagon to accommodate SAC bits

Tool - SAC BIT M12-D15 - 1208432



Nut for assembling sensor/actuator cables with M12 connector and M12 connectors for assembly, with a knurl diameter of 15 mm, for 4 mm hexagonal drive

Torque tool

Torque screwdriver - TSD 04 SAC - 1208429



Torque screwdriver, with preset torque of 0.4 Nm and 4 mm hexagonal drive for M12 connectors

Sensor/actuator cable - SAC-3P-MS/ 3,0-PUR/C-1L-Z SCO - 1435467

Accessories

Torque screwdriver - TSD-M 1,2NM - 1212224



Torque screw driver, accuracy as per EN ISO 6789 standard, adjustable from 0.3 - 1.2 Nm

Phoenix Contact 2020 © - all rights reserved
<http://www.phoenixcontact.com>

PHOENIX CONTACT GmbH & Co. KG
Flachsmarktstr. 8
32825 Blomberg
Germany
Tel. +49 5235 300
Fax +49 5235 3 41200
<http://www.phoenixcontact.com>

X-ON Electronics

Largest Supplier of Electrical and Electronic Components

Click to view similar products for [Sensor Cables / Actuator Cables](#) category:

Click to view products by [Phoenix Contact](#) manufacturer:

Other Similar products are found below :

[60963](#) [60964](#) [703000D02F2002](#) [703001D02F0602](#) [703001D02F300](#) [704000D02F120](#) [773032K02F030](#) [802027107404-1](#) [802027213811-1](#)
[804001A09M150](#) [805001A09M0502](#) [84914-0235](#) [84914-0237](#) [885030A09M020](#) [8R4J30E03C3003](#) [1200651332](#) [1200651713](#) [1200660844](#)
[1200660845](#) [1200661173](#) [1200680071](#) [1200720053](#) [1200720081](#) [1200720099](#) [1200720217](#) [1200800231](#) [1200860125](#) [1200870123](#)
[1200980102](#) [1200650267](#) [1200650298](#) [1200660183](#) [1200660782](#) [1200660849](#) [1200661295](#) [1200661297](#) [1200661342](#) [1200661343](#)
[1200670080](#) [1200670220](#) [1200680331](#) [1200720252](#) [1200730184](#) [1200860344](#) [1200870359](#) [1200870643](#) [1200980008](#) [1200980031](#)
[1210502211](#) [1210400542](#)