

Flush-type connector - SACC-EC-FS-8CON-M16/2,0 SCO - 1446391

Please be informed that the data shown in this PDF Document is generated from our Online Catalog. Please find the complete data in the user's documentation. Our General Terms of Use for Downloads are valid (<http://phoenixcontact.com/download>)



Sensor/actuator flush-type socket, 8-pos., M12 SPEEDCON, A-coded, front/screw mounting with M16 thread, can be positioned, with 2.0 m TPE litz wire, 8 x 0.25 mm²



Key Commercial Data

Packing unit	1 pc
Minimum order quantity	50 pc
GTIN	 4 046356 628389
GTIN	4046356628389

Technical data

Dimensions

Length of cable	2 m
-----------------	-----

Ambient conditions

Degree of protection	IP67
----------------------	------

General

Rated current at 40°C	2 A
Rated voltage	30 V
Number of positions	8
Insulation resistance	≥ 100 MΩ
Coding	A - standard
Standards/regulations	M12 connector IEC 61076-2-101
Signal type/category	Universal
Status display	No
Overvoltage category	II
Degree of pollution	3

Material

Flush-type connector - SACC-EC-FS-8CON-M16/2,0 SCO - 1446391

Technical data

Material

Flammability rating according to UL 94	V0
Contact material	CuZn
Contact surface material	Au
Contact carrier material	PA 6.6
Material, knurls	Zinc die-cast, nickel-plated

Cable

Cable type	TPE litz wire
Conductor cross section	0.25 mm ²
AWG signal line	24
Conductor structure signal line	14x 0.15 mm
Core diameter including insulation	1.15 mm ±0.07 mm
Thickness, insulation	0.21 mm (Core insulation)
Wire colors	Brown, blue, white, gray, pink, green, yellow, red
Material conductor insulation	TPE
Conductor material	Tin-plated Cu litz wires
Standards/specifications	M12 connector IEC 61076-2-101
Insulation resistance	≥ 20 MΩ*km
Conductor resistance	≤ 80 mΩ/m
Nominal voltage, cable	300 V
Test voltage, cable	2000 V AC

Standards and Regulations

Standards/specifications	M12 connector IEC 61076-2-101
Flammability rating according to UL 94	V0

Environmental Product Compliance

REACH SVHC	Lead 7439-92-1
China RoHS	Environmentally Friendly Use Period = 50 years
	For details about hazardous substances go to tab "Downloads", Category "Manufacturer's declaration"

Drawings

Flush-type connector - SACC-EC-FS-8CON-M16/2,0 SCO - 1446391

Schematic diagram

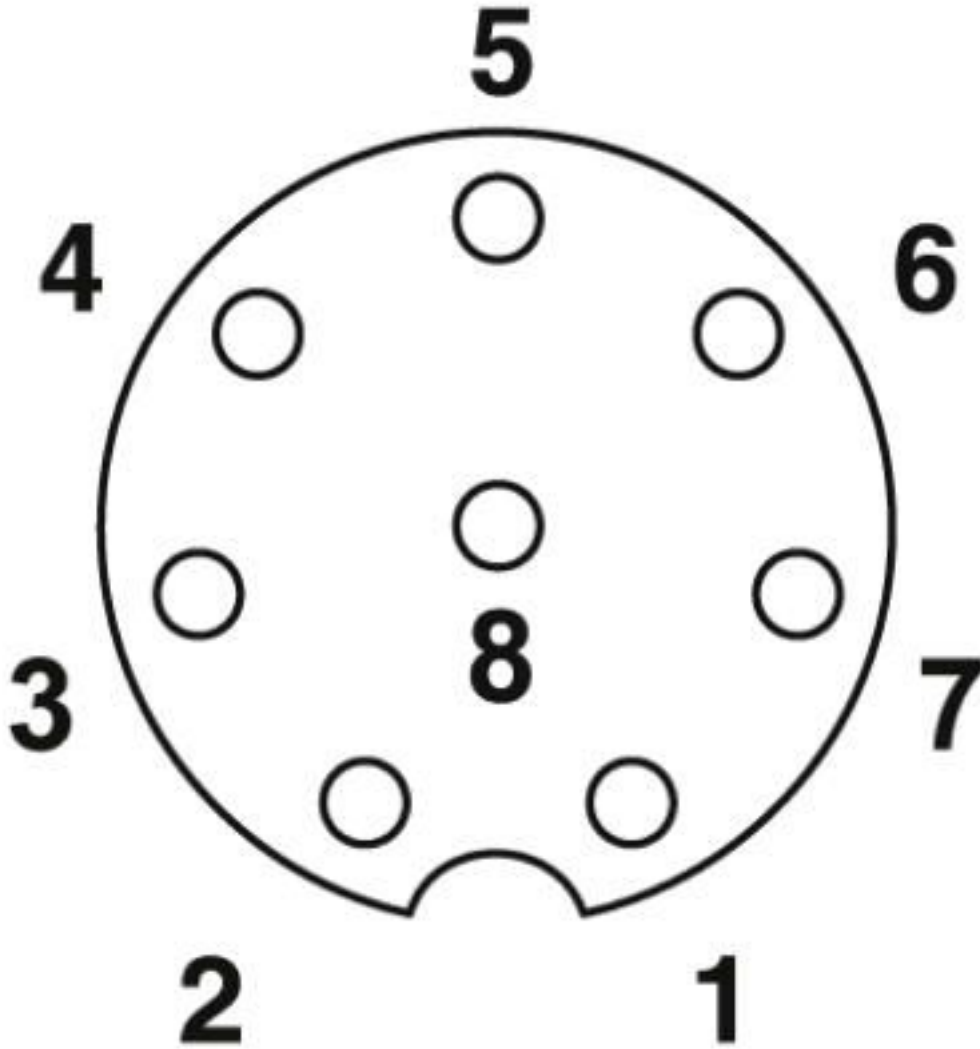

Pin assignment M12 socket, 8-pos., A-coded, view female side

Flush-type connector - SACC-EC-FS-8CON-M16/2,0 SCO - 1446391

Dimensional drawing

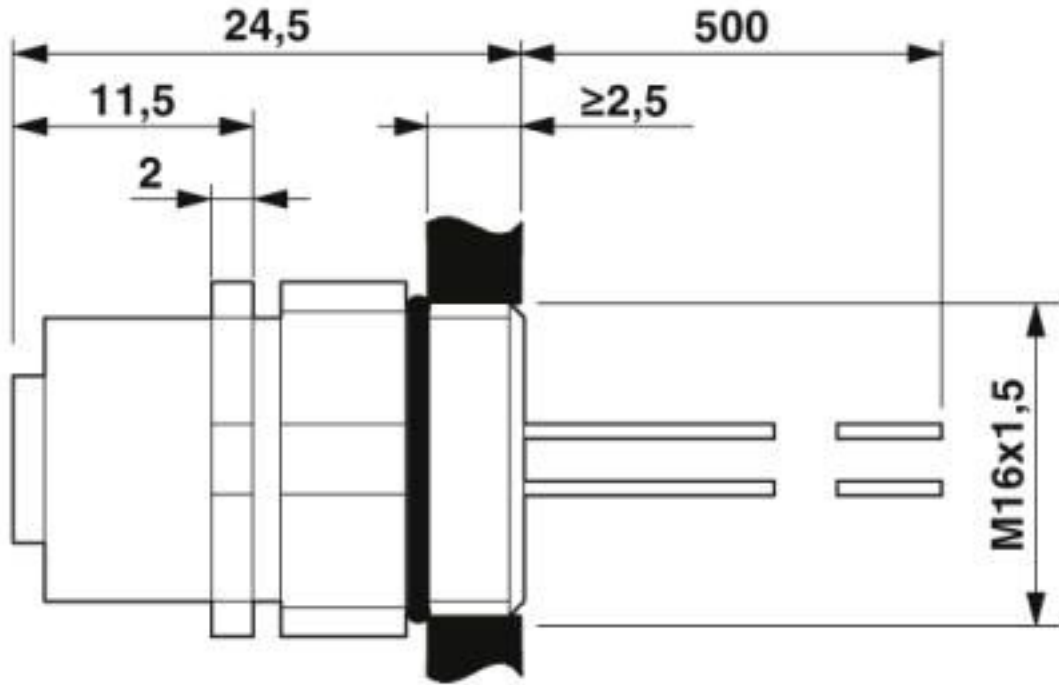

M12 flush-type socket, can be positioned

Dimensional drawing

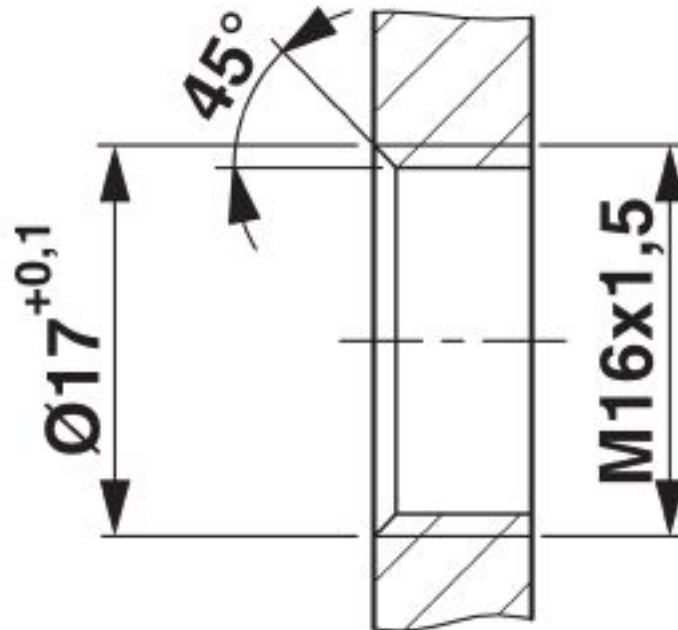

Housing cutout for M16 fastening thread, mounting panel with thread

Flush-type connector - SACC-EC-FS-8CON-M16/2,0 SCO - 1446391

Circuit diagram

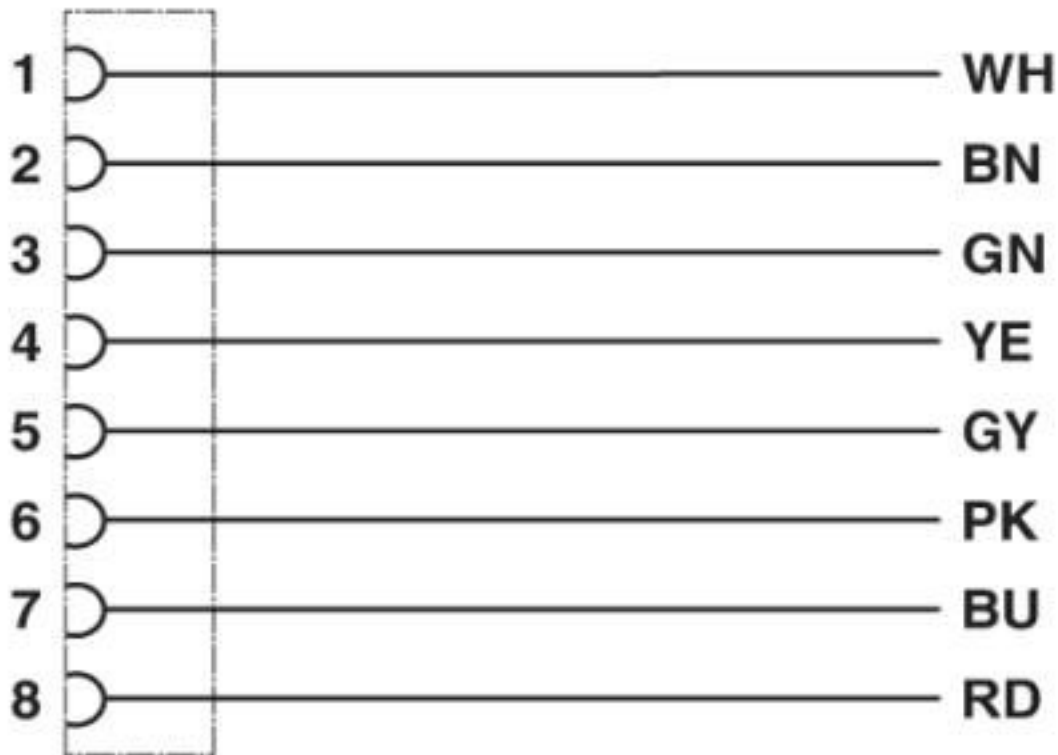

Contact assignment of the M12 socket

Classifications

eCl@ss

eCl@ss 10.0.1	27440102
eCl@ss 4.0	27140800
eCl@ss 4.1	27140800
eCl@ss 5.0	27143400
eCl@ss 5.1	27143400
eCl@ss 6.0	27279200
eCl@ss 7.0	27440103
eCl@ss 8.0	27440103
eCl@ss 9.0	27440102

ETIM

ETIM 4.0	EC002062
ETIM 5.0	EC002061
ETIM 6.0	EC002061

UNSPSC

UNSPSC 6.01	31251501
-------------	----------

Flush-type connector - SACC-EC-FS-8CON-M16/2,0 SCO - 1446391

Classifications

UNSPSC

UNSPSC 7.0901	31251501
UNSPSC 11	31251501
UNSPSC 12.01	31251501
UNSPSC 13.2	39121413
UNSPSC 18.0	39121413
UNSPSC 19.0	39121413
UNSPSC 20.0	39121413
UNSPSC 21.0	39121413

Approvals

Approvals

Approvals

UL Recognized / EAC

Ex Approvals

Approval details

UL Recognized		http://database.ul.com/cgi-bin/XYV/template/LISEXT/1FRAME/index.htm	FILE E 118976
Nominal voltage UN	30 V		
Nominal current IN	2 A		
mm ² /AWG/kcmil	24		

EAC		B.01687
-----	---	---------

X-ON Electronics

Largest Supplier of Electrical and Electronic Components

Click to view similar products for [Circular Metric Connectors](#) category:

Click to view products by [Phoenix Contact](#) manufacturer:

Other Similar products are found below :

[600X518037X](#) [6STD15PCR99B70A](#) [8R4000A16M020](#) [8R5000A16M005](#) [1200910002](#) [1203580030](#) [1200910008](#) [1200910011](#) [1300140094](#)
[130203-0054](#) [1300140026](#) [1300150099](#) [RF-12S1N8A90DU](#) [1-3637-600-5205](#) [1612618](#) [21036836414](#) [8R4006A16M010](#) [1604232](#)
[1R3006A20M005](#) [RF-12P1N8A90DU](#) [41-40011](#) [42-00006](#) [42-01015](#) [4-22279-4](#) [4-22281-1](#) [4-22284-9](#) [43-00113](#) [43-01088](#) [43-01203](#) [41-](#)
[40013](#) [42-00008](#) [43-00343](#) [43-01026](#) [43-01162](#) [43-01173](#) [43-10000](#) [XS3P-M421-2](#) [600X518050X](#) [SACC-DSI-FS-5P-PG9-L180 SC](#)
[8R5006A16M020](#) [8R5006A16M005](#) [8R4000A16M010](#) [6-22279-3](#) [1605332](#) [N03FA03144](#) [1300140077](#) [43-16213](#) [43-01338](#) [XS2RD4265](#)
[XS2R-D426-1](#)