

## Sensor/actuator cable - SAC-2P-MS/0,6-PUR/ZC-1L-S SCO - 1453274

Please be informed that the data shown in this PDF Document is generated from our Online Catalog. Please find the complete data in the user's documentation. Our General Terms of Use for Downloads are valid (<http://phoenixcontact.com/download>)



Sensor/actuator cable, 2-position, PUR, gray RAL 7001, Plug straight M12 SPEEDCON, coding: A, on Valve connector Festo ZC, with 1 LED, cable length: 0.6 m

### Your advantages

- ✓ Easy and safe: 100% electrically tested plug-in components
- ✓ Robust valve connector without protective circuit
- ✓ Save time, thanks to installation with SPEEDCON fast locking system
- ✓ Connecting cable specially for Festo KMYZ9 type valves



### Key Commercial Data

Packing unit	1 pc
GTIN	 4 046356 550987
GTIN	4046356550987

### Technical data

#### Dimensions

Length of cable	0.6 m
Central screw valve connector	M2

#### Ambient conditions

Ambient temperature (operation)	-25 °C ... 90 °C (Plug / socket)
	-10 °C ... 50 °C (valve plug)
Degree of protection	IP65
	IP67
	IP68

#### General

Rated current at 40°C	4 A
Rated voltage	24 V DC

# Sensor/actuator cable - SAC-2P-MS/0,6-PUR/ZC-1L-S SCO - 1453274

## Technical data

### General

Number of positions	2
Insulation resistance	≥ 100 MΩ
Coding	A - standard
Status display	1 LED
Overvoltage category	II
Degree of pollution	3
Insertion/withdrawal cycles	≥ 100
Torque	0.4 Nm (M12 connector)

### Material

Flammability rating according to UL 94	HB
Contact material	CuSn
Contact surface material	Ni/Au
Contact carrier material	TPU GF
Valve plug contact material	CuSn
Valve plug contact surface material	Sn
Material housing valve plug	PA
Material, knurls	Zinc die-cast, nickel-plated
Sealing material	NBR

### Standards and Regulations

Flammability rating according to UL 94	HB
--	----

### Cable

Conductor cross section	2x 0.25 mm <sup>2</sup> (Signal line)
AWG signal line	24
Wire colors	black, black
External sheath, color	gray RAL 7001
External cable diameter D	3.4 mm
Outer sheath, material	PUR
Conductor material	Bare Cu litz wires
Ambient temperature (operation)	-10 °C ... 50 °C (cable, fixed installation)
	-10 °C ... 50 °C (cable, flexible installation)

### Environmental Product Compliance

REACH SVHC	Lead 7439-92-1
China RoHS	Environmentally Friendly Use Period = 50 years
	For details about hazardous substances go to tab "Downloads", Category "Manufacturer's declaration"

## Drawings

# Sensor/actuator cable - SAC-2P-MS/0,6-PUR/ZC-1L-S SCO - 1453274

Dimensional drawing

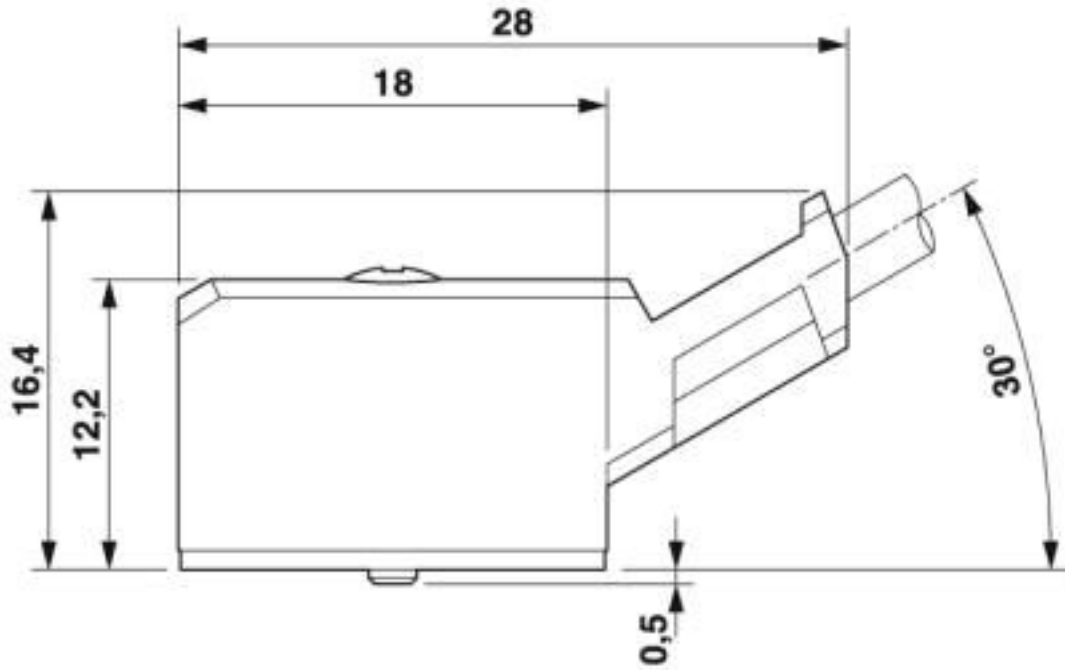

Dimensional drawing

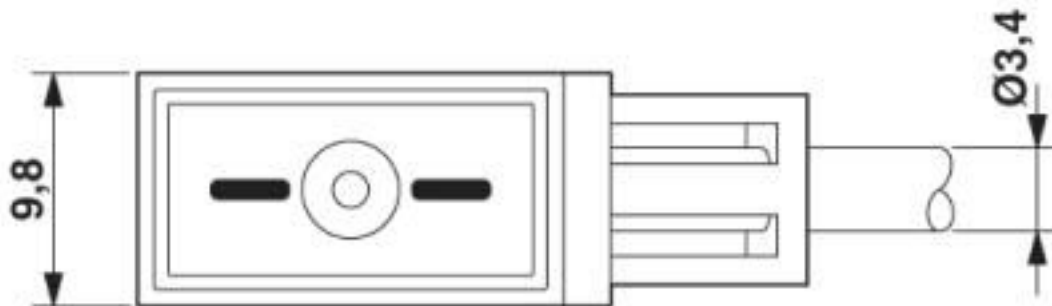

Dimensional drawing

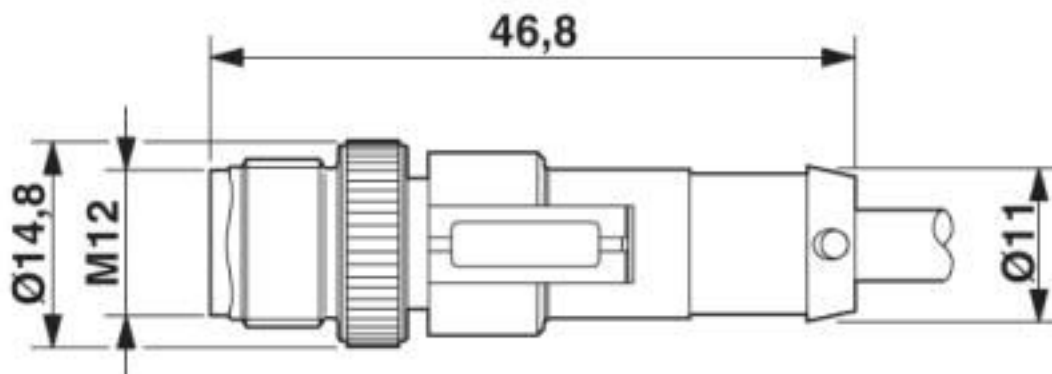

# Sensor/actuator cable - SAC-2P-MS/0,6-PUR/ZC-1L-S SCO - 1453274

Schematic diagram

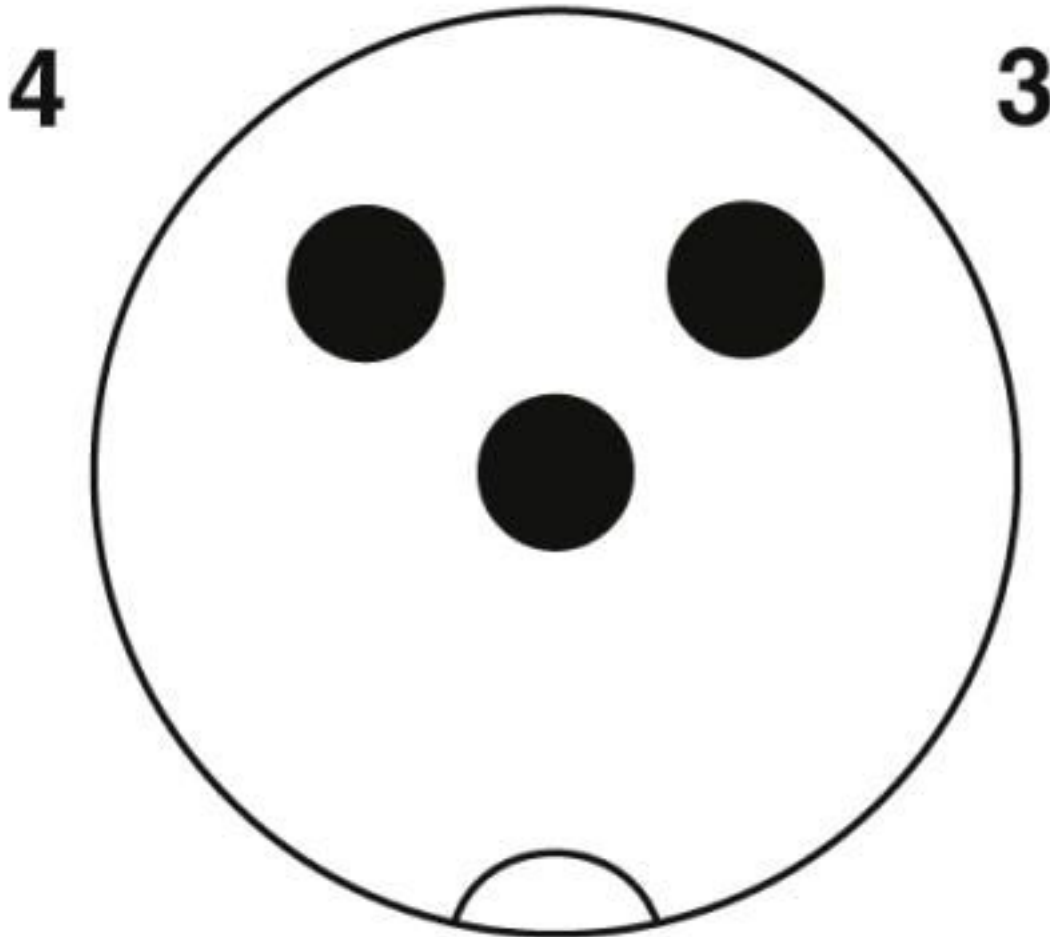

## Sensor/actuator cable - SAC-2P-MS/0,6-PUR/ZC-1L-S SCO - 1453274

Schematic diagram

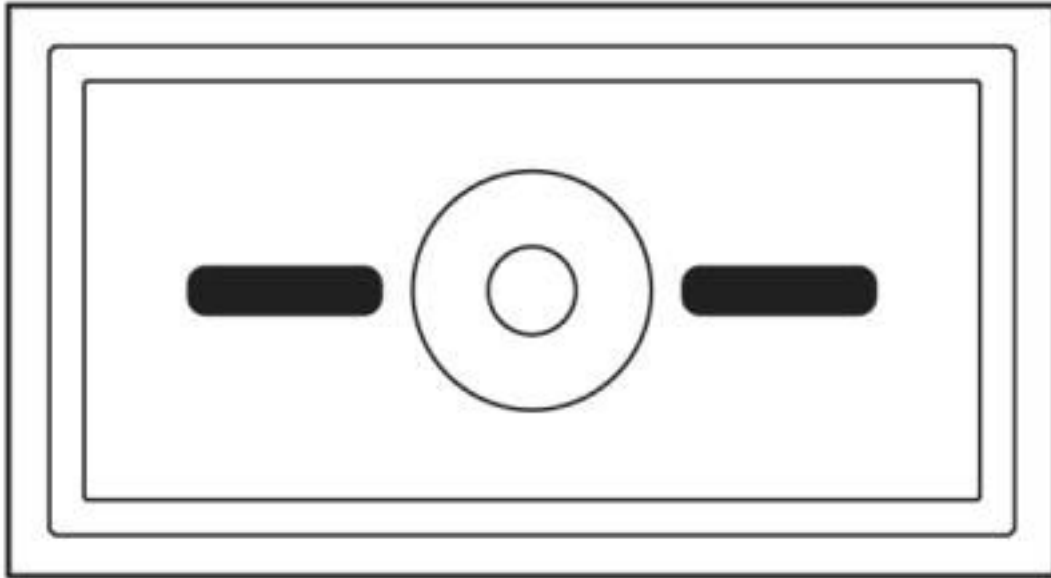

## Sensor/actuator cable - SAC-2P-MS/0,6-PUR/ZC-1L-S SCO - 1453274

Cable cross section

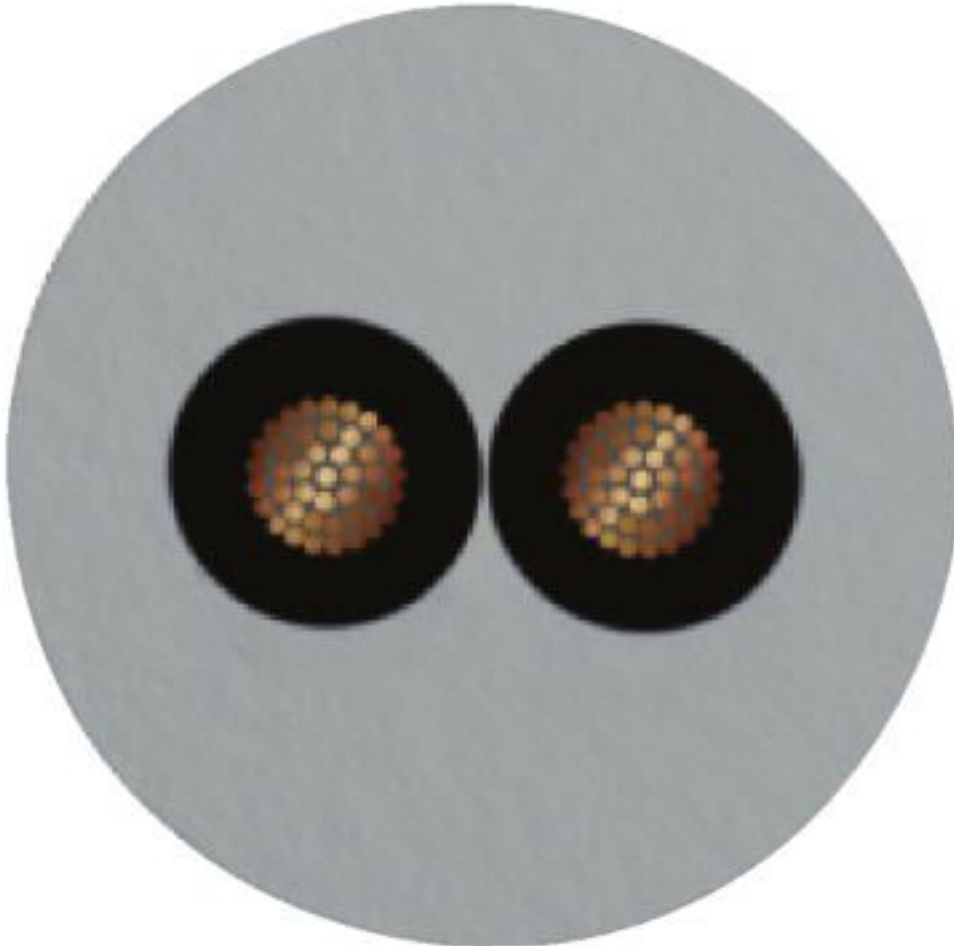

PUR gray [PUR]

### Classifications

eCl@ss

eCl@ss 10.0.1	27060312
eCl@ss 4.0	27060300
eCl@ss 4.1	27060300
eCl@ss 5.0	27061800
eCl@ss 5.1	27061800
eCl@ss 6.0	27279200
eCl@ss 7.0	27279218
eCl@ss 8.0	27279218
eCl@ss 9.0	27060312

# Sensor/actuator cable - SAC-2P-MS/0,6-PUR/ZC-1L-S SCO - 1453274

## Classifications

### ETIM

ETIM 3.0	EC001855
ETIM 4.0	EC001855
ETIM 5.0	EC001855
ETIM 6.0	EC001855
ETIM 7.0	EC001855

### UNSPSC

UNSPSC 6.01	31251501
UNSPSC 7.0901	31251501
UNSPSC 11	31251501
UNSPSC 12.01	31251501
UNSPSC 13.2	31251501
UNSPSC 19.0	31251501
UNSPSC 20.0	31251501
UNSPSC 21.0	31251501

## Approvals

### Approvals

---

Approvals

EAC-RoHS / EAC

---

Ex Approvals

---

### Approval details

EAC-RoHS		RU D- DE.HB35.B.00387
----------	--	--------------------------

EAC		RU C- DE.BL08.B.00286
-----	--	--------------------------

## Accessories

Accessories

Conductor marking

## Sensor/actuator cable - SAC-2P-MS/0,6-PUR/ZC-1L-S SCO - 1453274

### Accessories

Insert label - PABA WH/23 - 1013779



Insert label, Strip, white, unlabeled, can be labeled with: CMS-P1-PLOTTER, mounting type: thread on, cable diameter range: 1.5 ... 35 mm, lettering field size: 23 x 4 mm, Number of individual labels: 20

Insert label - PABA YE/23 - 1013782



Insert label, Strip, yellow, unlabeled, can be labeled with: CMS-P1-PLOTTER, mounting type: thread on, cable diameter range: 1.5 ... 35 mm, lettering field size: 23 x 4 mm, Number of individual labels: 20

### Marker pen

Marker pen - B-STIFT - 1051993



Marker pen, for manual labeling of unprinted Zack strips, smear-proof and waterproof, line thickness 0.5 mm

### Protective cap

Sealing cap - PROT-M12 FS-PA-CHAIN - 1430873

M12 sealing cap made of plastic with fixing band, for sensor cables, for free M12 plugs



### Safety locking

Locking clip - SAC-M12-EXCLIP-M - 1558988



Locking clip for the pin side of sensor/actuator cables with M12 connector and M12 connectors for assembly, for knurl diameter: 15 mm or for Allen key with a wrench size of 14 mm, prevents the disconnection of plug-in connections without tools

### Screwdriver tools



## Sensor/actuator cable - SAC-2P-MS/0,6-PUR/ZC-1L-S SCO - 1453274

### Accessories

Adapter insert - TSD-M SAC-BIT ADAPTER - 1212600



Adapter bit for TSD-M...torque tools, E6.3-1/4" drive with 4 mm hexagon to accommodate SAC bits

---

Tool - SAC BIT M12-D15 - 1208432



Nut for assembling sensor/actuator cables with M12 connector and M12 connectors for assembly, with a knurl diameter of 15 mm, for 4 mm hexagonal drive

---

Torque tool

Torque screwdriver - TSD 04 SAC - 1208429



Torque screwdriver, with preset torque of 0.4 Nm and 4 mm hexagonal drive for M12 connectors

---

Torque screwdriver - TSD-M 1,2NM - 1212224



Torque screw driver, accuracy as per EN ISO 6789 standard, adjustable from 0.3 - 1.2 Nm

---

Phoenix Contact 2020 © - all rights reserved  
<http://www.phoenixcontact.com>

PHOENIX CONTACT GmbH & Co. KG  
Flachsmarktstr. 8  
32825 Blomberg  
Germany  
Tel. +49 5235 300  
Fax +49 5235 3 41200  
<http://www.phoenixcontact.com>

## X-ON Electronics

Largest Supplier of Electrical and Electronic Components

*Click to view similar products for [Sensor Cables / Actuator Cables](#) category:*

*Click to view products by [Phoenix Contact](#) manufacturer:*

Other Similar products are found below :

[60963](#) [60964](#) [703000D02F2002](#) [703001D02F0602](#) [703001D02F300](#) [704000D02F120](#) [773032K02F030](#) [802027107404-1](#) [802027213811-1](#)  
[804001A09M150](#) [805001A09M0502](#) [84914-0235](#) [84914-0237](#) [885030A09M020](#) [8R4J30E03C3003](#) [1200651332](#) [1200651713](#) [1200660844](#)  
[1200660845](#) [1200661173](#) [1200680071](#) [1200720053](#) [1200720081](#) [1200720099](#) [1200720217](#) [1200800231](#) [1200860125](#) [1200870123](#)  
[1200980102](#) [1200650267](#) [1200650298](#) [1200660183](#) [1200660782](#) [1200660849](#) [1200661295](#) [1200661297](#) [1200661342](#) [1200661343](#)  
[1200670080](#) [1200670220](#) [1200680331](#) [1200720252](#) [1200730184](#) [1200860344](#) [1200870359](#) [1200870643](#) [1200980008](#) [1200980031](#)  
[1210502211](#) [1210400542](#)