

Flush-type connector - SACC-DSI-M 8MS-6CON-M 8/0,5 - 1453494

Please be informed that the data shown in this PDF Document is generated from our Online Catalog. Please find the complete data in the user's documentation. Our General Terms of Use for Downloads are valid (<http://phoenixcontact.com/download>)



Flush-type connector, 6-position, Plug, straight, M8, Rear mounting, M8 x 1, Individual wires, cable length: 0.5 m, 0.14 mm², PVC litz wire

Your advantages

- ✓ Pre-assembled with litz wires for immediate use
- ✓ Customer-specific assemblies and litz wire lengths available
- ✓ Sealed on the litz wire side for optimum leak-tightness
- ✓ Standard pin assignments and codings for signal transmission with a uniform design-in design

Key Commercial Data

Packing unit	1 pc
GTIN	 4 046356 554428
GTIN	4046356554428

Technical data

Dimensions

Length of cable	0.5 m
-----------------	-------

Ambient conditions

Ambient temperature (operation)	-25 °C ... 85 °C (Plug)
Degree of protection	IP67

General

Rated current at 40°C	2 A
Rated voltage	30 V AC 30 V DC
Rated surge voltage	0.8 kV
Number of positions	6
Insulation resistance	≥ 100 MΩ

Flush-type connector - SACC-DSI-M 8MS-6CON-M 8/0,5 - 1453494

Technical data

General

Coding	A - standard
Standards/regulations	M8 connector IEC 61076-2-104
Status display	No
Overvoltage category	II
Degree of pollution	3
Connection method	Individual wires
Torque	1 Nm ... 1.5 Nm (Installation-side)
Mounting type	Rear mounting M8 x 1 With flat nut

Material

Flammability rating according to UL 94	HB
Contact material	Cu alloy
Contact surface material	Au
Contact carrier material	PUR / PA 6.6
Material, knurls	Nickel-plated brass
Sealing material	FKM
Additional material specifications	EP (Grout material)

Cable

Cable type	PVC litz wire
Conductor cross section	0.14 mm ²
AWG signal line	24
Conductor structure signal line	7x 0.16 mm
Core diameter including insulation	1.3 mm ±0.1 mm
Thickness, insulation	0.38 mm
Wire colors	Black, brown, blue, white, gray, pink
Material conductor insulation	PVC / UL
Conductor material	Tin-plated Cu litz wires
Standards/specifications	M8 connector IEC 61076-2-104
Insulation resistance	≥ 20 MΩ*km
Conductor resistance	≥ 80 Ω/km
Nominal voltage, cable	300 V
Test voltage, cable	2000 V AC
Ambient temperature (operation)	-40 °C ... 105 °C (cable, fixed installation)
	-10 °C ... 105 °C (cable, flexible installation)

Standards and Regulations

Standards/specifications	M8 connector IEC 61076-2-104
Flammability rating according to UL 94	HB

Environmental Product Compliance

China RoHS	Environmentally Friendly Use Period = 25;
------------	---

Flush-type connector - SACC-DSI-M 8MS-6CON-M 8/0,5 - 1453494

Technical data

Environmental Product Compliance

	For details about hazardous substances go to tab "Downloads", Category "Manufacturer's declaration"
--	---

Drawings

Dimensional drawing

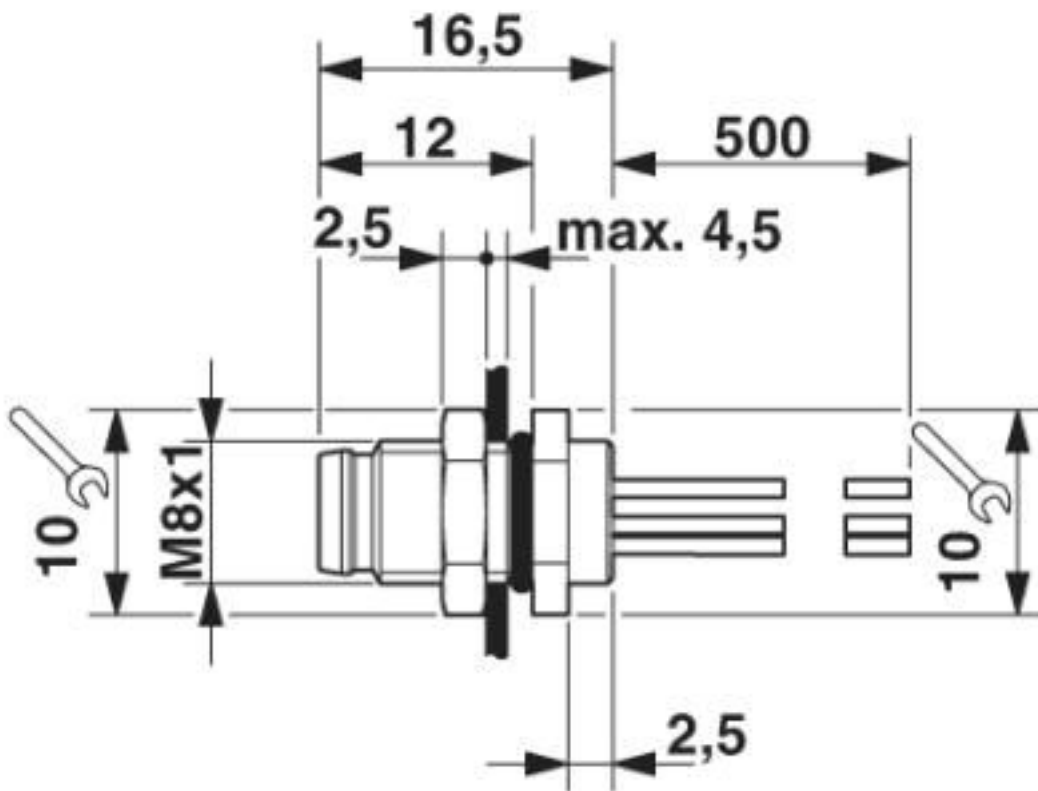

M8 flush-type plug

Flush-type connector - SACC-DSI-M 8MS-6CON-M 8/0,5 - 1453494

Dimensional drawing

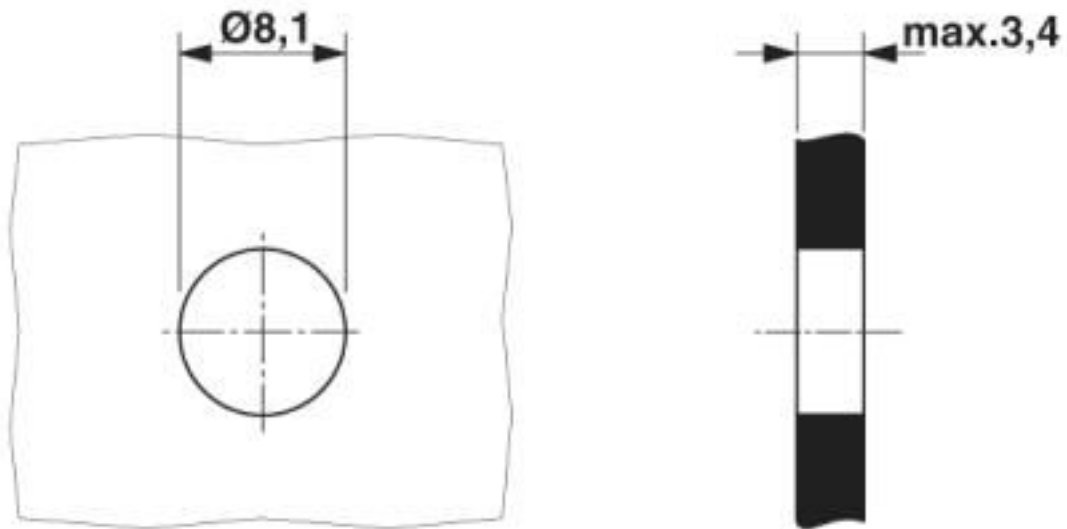

Housing cutout for M8 flush-type connector, connector, one-section

Flush-type connector - SACC-DSI-M 8MS-6CON-M 8/0,5 - 1453494

Schematic diagram

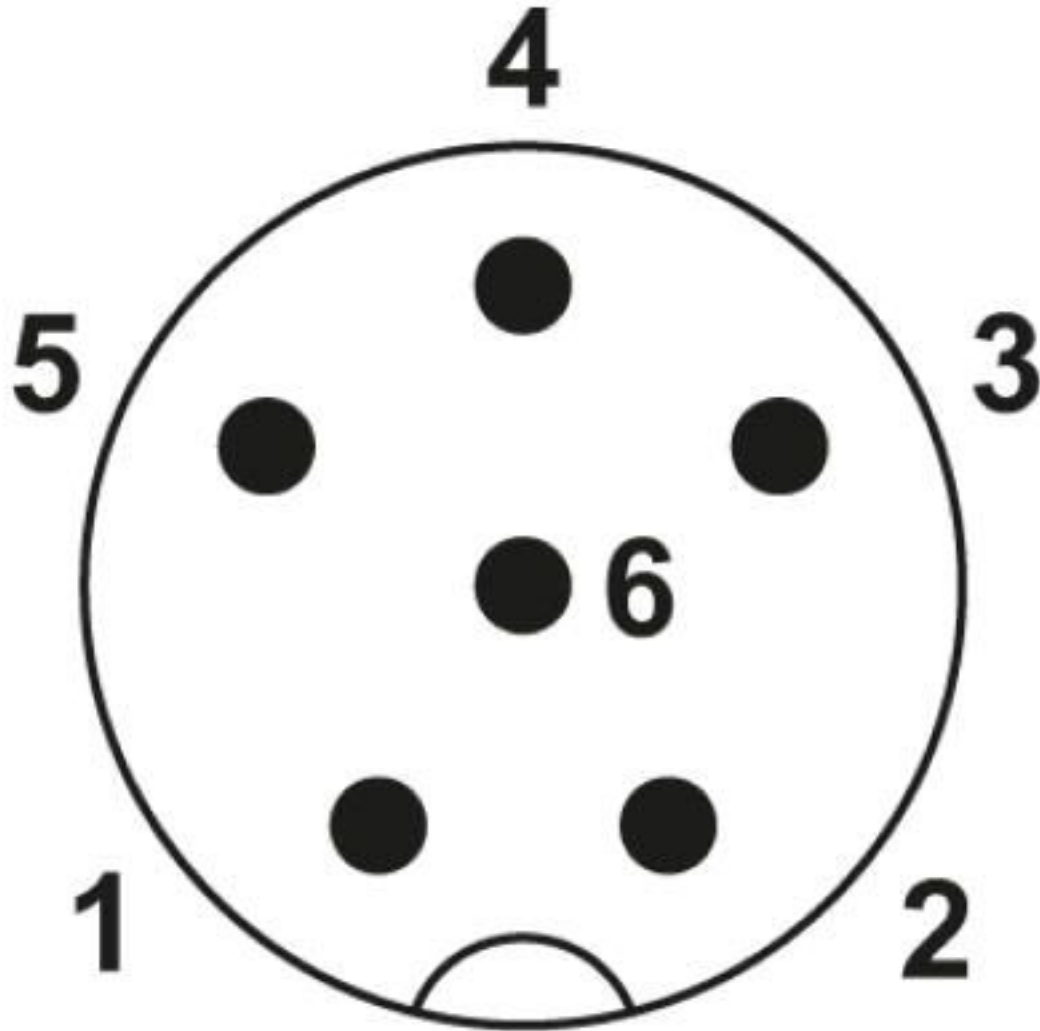

Pin assignment M8 plug, 6-pos., view male side

Classifications

eCl@ss

eCl@ss 10.0.1	27440102
eCl@ss 4.0	27260700
eCl@ss 4.1	27260700
eCl@ss 5.0	27260700
eCl@ss 5.1	27260700
eCl@ss 6.0	27279200
eCl@ss 7.0	27440103
eCl@ss 8.0	27440103
eCl@ss 9.0	27440102

Flush-type connector - SACC-DSI-M 8MS-6CON-M 8/0,5 - 1453494

Classifications

ETIM

ETIM 3.0	EC002061
ETIM 4.0	EC002061
ETIM 5.0	EC002061
ETIM 6.0	EC002061

UNSPSC

UNSPSC 6.01	31251501
UNSPSC 7.0901	31251501
UNSPSC 11	31251501
UNSPSC 12.01	31251501
UNSPSC 13.2	39121413
UNSPSC 18.0	39121413
UNSPSC 19.0	39121413
UNSPSC 20.0	39121413
UNSPSC 21.0	39121413

Approvals

Approvals

Approvals

UL Recognized / cUL Recognized / EAC / cULus Recognized

Ex Approvals

Approval details

UL Recognized		http://database.ul.com/cgi-bin/XYV/template/LISEXT/1FRAME/index.htm	FILE E 221474
Nominal voltage UN	30 V		
Nominal current IN	1.5 A		
mm ² /AWG/kcmil	26		

cUL Recognized		http://database.ul.com/cgi-bin/XYV/template/LISEXT/1FRAME/index.htm	FILE E 221474
Nominal voltage UN	30 V		

Flush-type connector - SACC-DSI-M 8MS-6CON-M 8/0,5 - 1453494

Approvals

Nominal current I _N	1.5 A
mm ² /AWG/kcmil	26

EAC		B.01687
-----	---	---------

cULus Recognized	
------------------	---

Phoenix Contact 2020 © - all rights reserved
<http://www.phoenixcontact.com>

PHOENIX CONTACT GmbH & Co. KG
Flachsmarktstr. 8
32825 Blomberg
Germany
Tel. +49 5235 300
Fax +49 5235 3 41200
<http://www.phoenixcontact.com>

X-ON Electronics

Largest Supplier of Electrical and Electronic Components

Click to view similar products for [Circular Metric Connectors](#) category:

Click to view products by [Phoenix Contact](#) manufacturer:

Other Similar products are found below :

[600X518037X](#) [6STD15PCR99B70A](#) [8R4000A16M020](#) [8R5000A16M005](#) [1200910002](#) [1203580030](#) [1200910008](#) [1200910011](#) [1300140094](#)
[130203-0054](#) [1300140026](#) [1300150099](#) [RF-12S1N8A90DU](#) [1-3637-600-5205](#) [1612618](#) [21036836414](#) [8R4006A16M010](#) [1604232](#)
[1R3006A20M005](#) [RF-12P1N8A90DU](#) [41-40011](#) [42-00006](#) [42-01015](#) [4-22279-4](#) [4-22281-1](#) [4-22284-9](#) [43-00113](#) [43-01088](#) [43-01203](#) [41-](#)
[40013](#) [42-00008](#) [43-00343](#) [43-01026](#) [43-01162](#) [43-01173](#) [43-10000](#) [XS3P-M421-2](#) [600X518050X](#) [SACC-DSI-FS-5P-PG9-L180 SC](#)
[8R5006A16M020](#) [8R5006A16M005](#) [8R4000A16M010](#) [6-22279-3](#) [1605332](#) [N03FA03144](#) [1300140077](#) [43-16213](#) [43-01338](#) [XS2RD4265](#)
[XS2R-D426-1](#)