

Network cable - VS-M12MSD/ 5,0-93X OD - 1454215

Please be informed that the data shown in this PDF Document is generated from our Online Catalog. Please find the complete data in the user's documentation. Our General Terms of Use for Downloads are valid (<http://phoenixcontact.com/download>)



Network cable, Ethernet CAT5 (100 Mbps), PROFINET CAT5 (100 Mbps), 4-position, PE-X halogen-free, black-gray RAL 7021, shielded, Plug straight M12 / IP69K, coding: D, on free cable end, cable length: 5 m, for outdoor applications, with high-grade steel knurl



Ethernet

Key Commercial Data

Packing unit	1 pc
GTIN	 4 046356 568821
GTIN	4046356568821

Technical data

Dimensions

Length of cable	5 m
-----------------	-----

Ambient conditions

Ambient temperature (operation)	-40 °C ... 105 °C
	-40 °C ... 85 °C (On sudden changes in temperature (according to IEC 60512-11-4))
Degree of protection	IP65
	IP67
	IP68
	IP69K

General

Rated current at 40°C	4 A
Rated voltage	48 V AC
	60 V DC
Number of positions	4
Coding	D - data
Standards/regulations	M12 connector IEC 61076-2-101
Signal type/category	Ethernet CAT5 (IEC 11801), 100 Mbps

Network cable - VS-M12MSD/ 5,0-93X OD - 1454215

Technical data

General

	PROFINET CAT5 (IEC 11801), 100 Mbps
Status display	No
Degree of pollution	3
Insertion/withdrawal cycles	≥ 100
Torque	0.4 Nm (M12 connector)
Transmission characteristics (category)	CAT5

Material

Flammability rating according to UL 94	V0
Contact material	CuSn
Contact surface material	Ni/Au
Contact carrier material	PP
Material of grip body	PP
Material, knurls	Stainless steel
Sealing material	FPM

Standards and Regulations

Standards/specifications	M12 connector IEC 61076-2-101
Flammability rating according to UL 94	V0

Cable

Cable type	PROFINET outdoors
Cable type (abbreviation)	93X
Cable structure	1x4xAWG22/7; SF/TQ
Conductor cross section	4x 0.34 mm ²
AWG signal line	22
Conductor structure signal line	7x 0.25 mm
Core diameter including insulation	1.95 mm
Wire colors	white-blue, orange-yellow
Overall twist	Star quad
Shielding	Plastic-coated aluminum foil, tinned copper braided shield
Optical shield covering	100 %
External sheath, color	black RAL 9005
Outer sheath thickness	≥ 0.8 mm
External cable diameter D	7.25 mm ±0.3 mm
Minimum bending radius, fixed installation	6 x D
Minimum bending radius, flexible installation	10 x D
Cable weight	81 g/m
Outer sheath, material	PE-X
Material conductor insulation	PE-X
Conductor material	silver-plated Cu litz wires
Conductor resistance	≤ 54.4 Ω/km

Network cable - VS-M12MSD/ 5,0-93X OD - 1454215

Technical data

Cable

Working capacitance	≤ 65 pF (core-core)
	≤ 100 pF (core-shield)
Wave impedance	100 Ω ±5 Ω (f = 100 MHz)
Signal speed	66 c
Shield attenuation	40 dB (30 MHz ≤ f ≤ 100 MHz)
Coupling resistance	200.00 mΩ/m (f ≤ 30 MHz)
Nominal voltage, cable	300 V AC
Test voltage, cable	2000 V AC (50 Hz, 5 minutes)
Fire protection in rail vehicles	BS 6853 (Category Ia, Ib, II)
	GM/RT 2130 (Category Ia, Ib, II)
	EN 45545 (Risk level HL1 - HL3)
	DIN 5510 (Fire protection level 1, 2, 3, 4)
	NF F16-101 (Category A1, A2, B)
	NF F16-101 (Class C/F0)
	NFPA 130
	UNI CEI 11170 (Risk level LR1 - LR4)
Flame resistance	EN 60332-1-2
	EN 50266
	EN 60332-3-25
	NF C32-070, 2.1
	NF C32-070, 2.2
	UL 1685, 12 (FT4)
	in accordance with ISO 6722-1 5.22 (UN ECE-R 118.01)
Halogen-free	According to EN 50267-2-1
Resistance to oil	according to IRM 902, 72 h at 100 °C
Other resistance	Resistance to fuels according to IRM 903, 168 h at 70 °C
Concentration of fumes	BS 6853 D.8.7
	EN 61034-2
	UL 1685, 12 (FT4)
Fume corrosiveness	EN 50267-2-2
Fume toxicity	BS 6853 B.1
	EN 50305, 9.2
Ambient temperature (operation)	-50 °C ... 90 °C (cable, fixed installation)
	-40 °C ... 90 °C (cable, flexible installation)

Environmental Product Compliance

REACH SVHC	Lead 7439-92-1
China RoHS	Environmentally Friendly Use Period = 50 years
	For details about hazardous substances go to tab "Downloads", Category "Manufacturer's declaration"

Network cable - VS-M12MSD/ 5,0-93X OD - 1454215

Drawings

Dimensional drawing

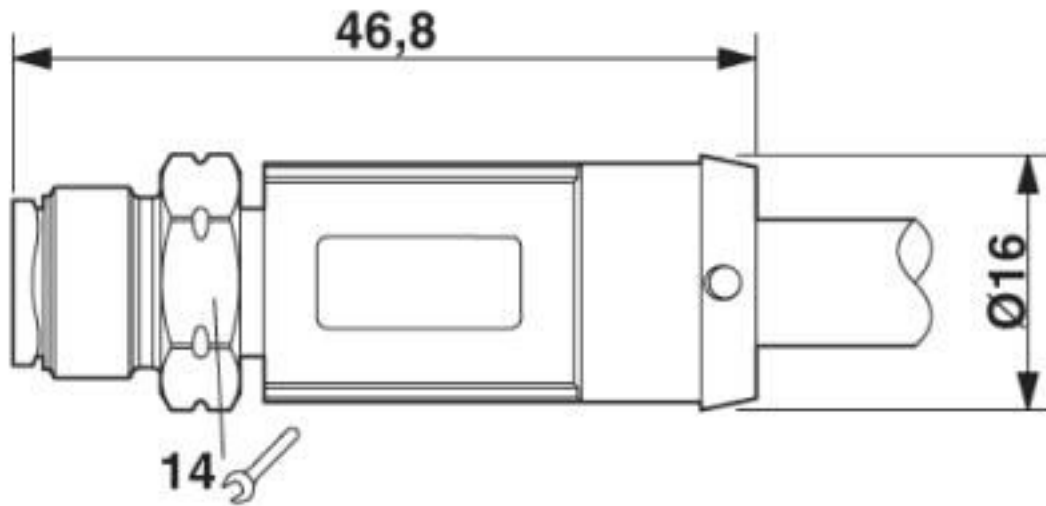

Plug, M12 x 1, straight, shielded

Circuit diagram

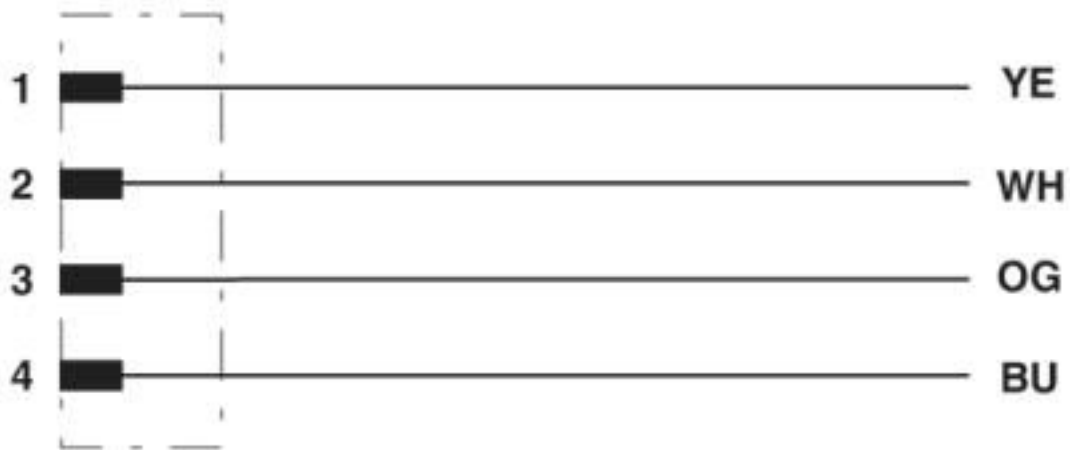

Contact assignment of the M12 plug

Network cable - VS-M12MSD/ 5,0-93X OD - 1454215

Schematic diagram

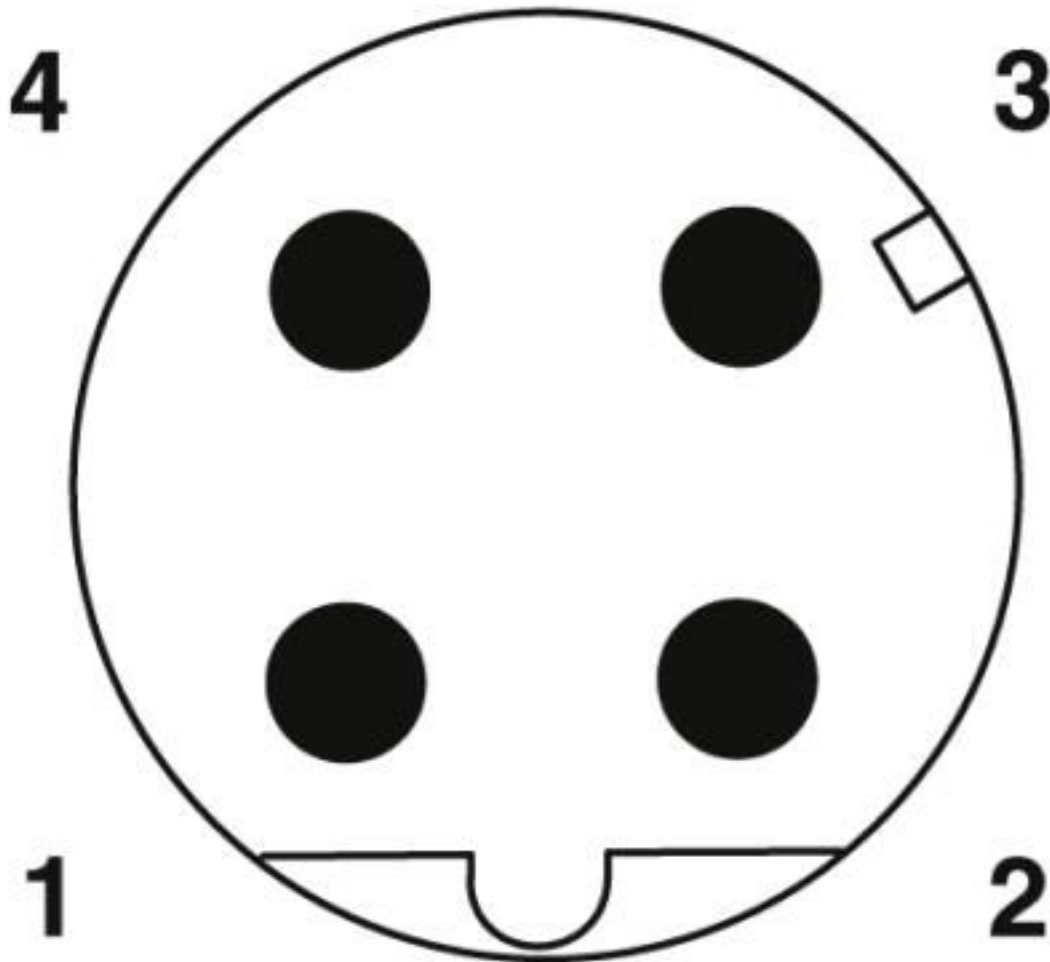

Pin assignment M12 male connector, 4-pos., D-coded, male side

Network cable - VS-M12MSD/ 5,0-93X OD - 1454215

Cable cross section

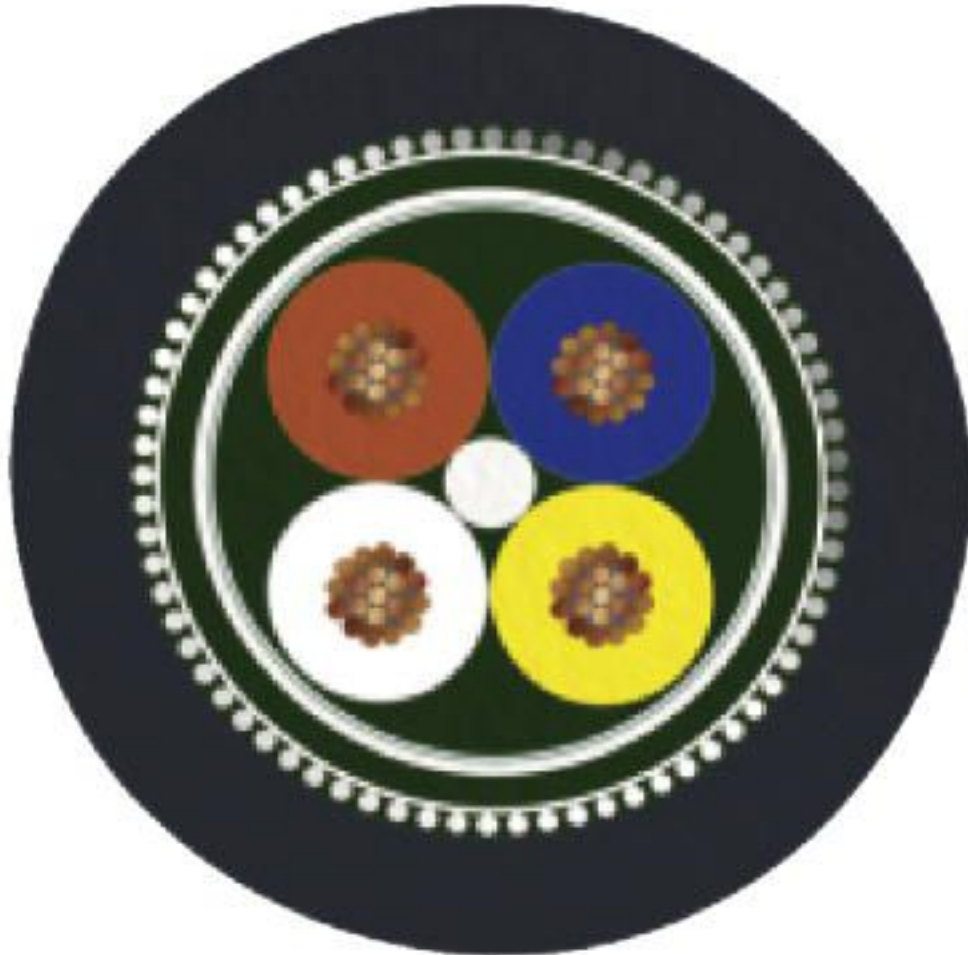

PROFINET outdoors [93X]

Classifications

eCl@ss

eCl@ss 10.0.1	27060308
eCl@ss 4.0	27060300
eCl@ss 4.1	27060300
eCl@ss 5.0	27060300
eCl@ss 5.1	27060300
eCl@ss 6.0	27279200
eCl@ss 7.0	27279218
eCl@ss 8.0	27279218
eCl@ss 9.0	27060308

Network cable - VS-M12MSD/ 5,0-93X OD - 1454215

Classifications

ETIM

ETIM 3.0	EC000830
ETIM 4.0	EC000830
ETIM 5.0	EC002599
ETIM 6.0	EC001262
ETIM 7.0	EC001262

UNSPSC

UNSPSC 6.01	31261501
UNSPSC 7.0901	31261501
UNSPSC 11	31261501
UNSPSC 12.01	31261501
UNSPSC 13.2	31251501
UNSPSC 18.0	26121604
UNSPSC 19.0	26121604
UNSPSC 20.0	26121604
UNSPSC 21.0	26121604

Approvals

Approvals

Approvals

EAC-RoHS / EAC

Ex Approvals

Approval details

EAC-RoHS		RU D- DE.HB35.B.00385
----------	--	--------------------------

EAC		RU C- DE.BL08.B.00286
-----	--	--------------------------

Accessories

Accessories

Screwdriver tools

Network cable - VS-M12MSD/ 5,0-93X OD - 1454215

Accessories

Adapter insert - TSD-M SAC-BIT ADAPTER - 1212600



Adapter bit for TSD-M...torque tools, E6.3-1/4" drive with 4 mm hexagon to accommodate SAC bits

Adapter - SAC BIT M12-W14 - 1212513



Nut for assembling sensor/actuator cables with M12 connector and M12 connectors for assembly, with a hexagonal knurl wrench size of 14 mm, with 4 mm hexagonal drive

Torque tool

Torque screwdriver - TSD 04 SAC - 1208429



Torque screwdriver, with preset torque of 0.4 Nm and 4 mm hexagonal drive for M12 connectors

Torque screwdriver - TSD-M 1,2NM - 1212224



Torque screw driver, accuracy as per EN ISO 6789 standard, adjustable from 0.3 - 1.2 Nm

Phoenix Contact 2020 © - all rights reserved
<http://www.phoenixcontact.com>

PHOENIX CONTACT GmbH & Co. KG
Flachsmarktstr. 8
32825 Blomberg
Germany
Tel. +49 5235 300
Fax +49 5235 3 41200
<http://www.phoenixcontact.com>

X-ON Electronics

Largest Supplier of Electrical and Electronic Components

Click to view similar products for [Ethernet Cables / Networking Cables](#) category:

Click to view products by [Phoenix Contact](#) manufacturer:

Other Similar products are found below :

[73-6670-7](#) [73-6680-15](#) [73-7797-25](#) [MCJB2-10P6Q7-120](#) [84909-0204](#) [1200700174](#) [1200860368](#) [E16A06002M030](#) [E200102-009-S1](#)
[AX105346-EW](#) [MT14-187L](#) [17-103530](#) [ERWPAB3002M005](#) [190-038045-01](#) [NK5EPC18RDY](#) [NK5EPC18VLY](#) [NK5EPC18YLY](#)
[NK5EPC1GRY](#) [NK5EPC4Y](#) [NK5EPC6YLY](#) [NK5EPC8BLY](#) [NK5EPC9YLY](#) [1969343-6](#) [C501100010](#) [C501106002](#) [C501106007](#)
[C501106015](#) [C501106025](#) [C601102010](#) [C601104010](#) [C601106007](#) [C601106015](#) [2142758-2](#) [2168427-2](#) [CAT1106007](#) [21949-1](#) [2J1866A](#)
[RJF SFTP 5E 0500](#) [AX100351](#) [MN14CEC/ST](#) [C501100015](#) [C501106004](#) [C501106010](#) [C5F1108007](#) [C601104004](#) [C601106004](#)
[CA21106004](#) [CA21106010](#) [CA21106015](#) [CA21109007](#)