

# Connector - SACC-MINFS-5CON-PG13/2,5 - 1456284

Please be informed that the data shown in this PDF Document is generated from our Online Catalog. Please find the complete data in the user's documentation. Our General Terms of Use for Downloads are valid (<http://phoenixcontact.com/download>)



Connector, Universal, 5-position, Socket straight 7/8"-UNF, Coding: A, Screw connection, knurl material: Zinc die-cast, nickel-plated, cable gland Pg13,5, external cable diameter 10 mm ... 12 mm

## Your advantages

- ✓ Safe use in the field, thanks to a high degree of protection
- ✓ Flexible: connectors for on-site assembly
- ✓ Screw connection: proven connection technology for a large selection of different conductors

RoHS

## Key Commercial Data

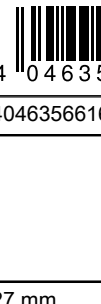
Packing unit	1 pc
GTIN	
GTIN	4046356616911

## Technical data

### Dimensions

Diameter housing	27 mm
Length	83.7 mm
External cable diameter	10 mm ... 12 mm
Stripping length of the sheath	30 mm
Stripping length of the individual wire	7 mm

### Ambient conditions

Ambient temperature (operation)	-25 °C ... 85 °C (Plug / socket)
Degree of protection	IP67

### General

Note	NOTE: Observe the permissible bending radii when laying conductors, since the degree of protection may be put in jeopardy if the bending forces are too high. Alleviate mechanical loads upstream of the connector, e.g. by using cable ties.
------	---

# Connector - SACC-MINFS-5CON-PG13/2,5 - 1456284

## Technical data

### General

Rated current at 40°C	9 A
Rated voltage	300 V AC
	300 V DC
Number of positions	5
Color handle area	black
Insulation resistance	≥ 100 MΩ
Coding	A - standard
Signal type/category	Universal
Status display	No
Overvoltage category	III
Degree of pollution	3
Connection method	Screw connection
Conductor cross section	0.34 mm <sup>2</sup> ... 2.5 mm <sup>2</sup> (without ferrule)
	0.34 mm <sup>2</sup> ... 2.5 mm <sup>2</sup> (with ferrule)
	0.34 mm <sup>2</sup> ... 2.5 mm <sup>2</sup> (solid)
Conductor cross section AWG	22 ... 14 (without ferrule)
	22 ... 14 (with ferrule)
Insertion/withdrawal cycles	≥ 100
Torque	0.8 Nm (7/8" connectors)
	0.4 Nm (Screw terminal blocks)
	1 Nm ... 1.4 Nm (Pressure screw)
Tightening torque	Screw plug insert with sleeve housing as far it will go
Assembly instructions	The wires can be connected both with ferrules and without ferrules

### Material

Flammability rating according to UL 94	HB
Contact material	CuZn
Contact surface material	Au
Contact carrier material	PUR / PA 6.6
Material of grip body	PBT
Material, knurls	Zinc die-cast, nickel-plated

### Standards and Regulations

Connection in acc. with standard	CUL
Flammability rating according to UL 94	HB

### Environmental Product Compliance

REACH SVHC	Lead 7439-92-1
China RoHS	Environmentally Friendly Use Period = 50 years
	For details about hazardous substances go to tab "Downloads", Category "Manufacturer's declaration"

## Drawings

# Connector - SACC-MINFS-5CON-PG13/2,5 - 1456284

Functional drawing

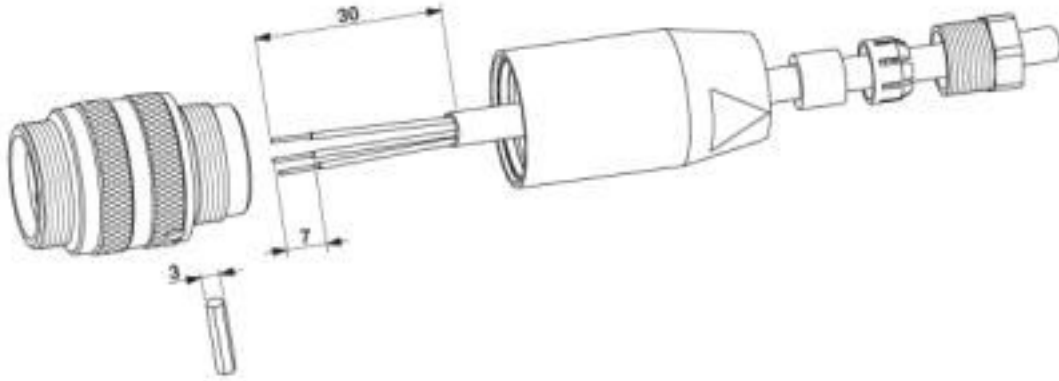

Dimensional drawing

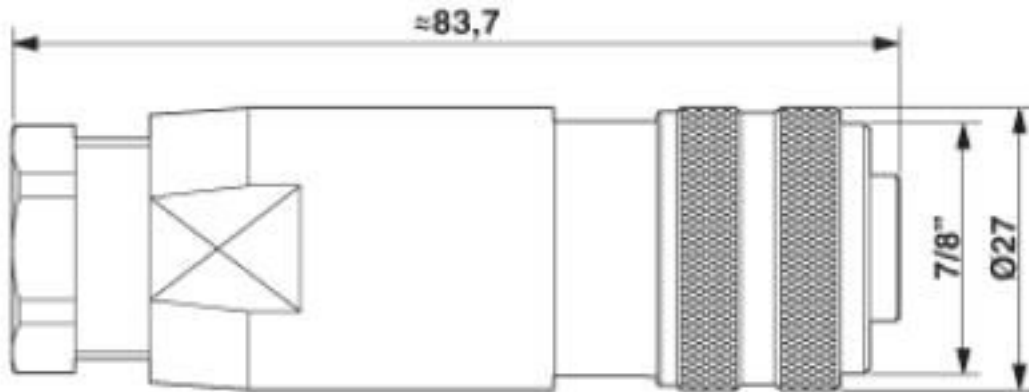

# Connector - SACC-MINFS-5CON-PG13/2,5 - 1456284

Schematic diagram

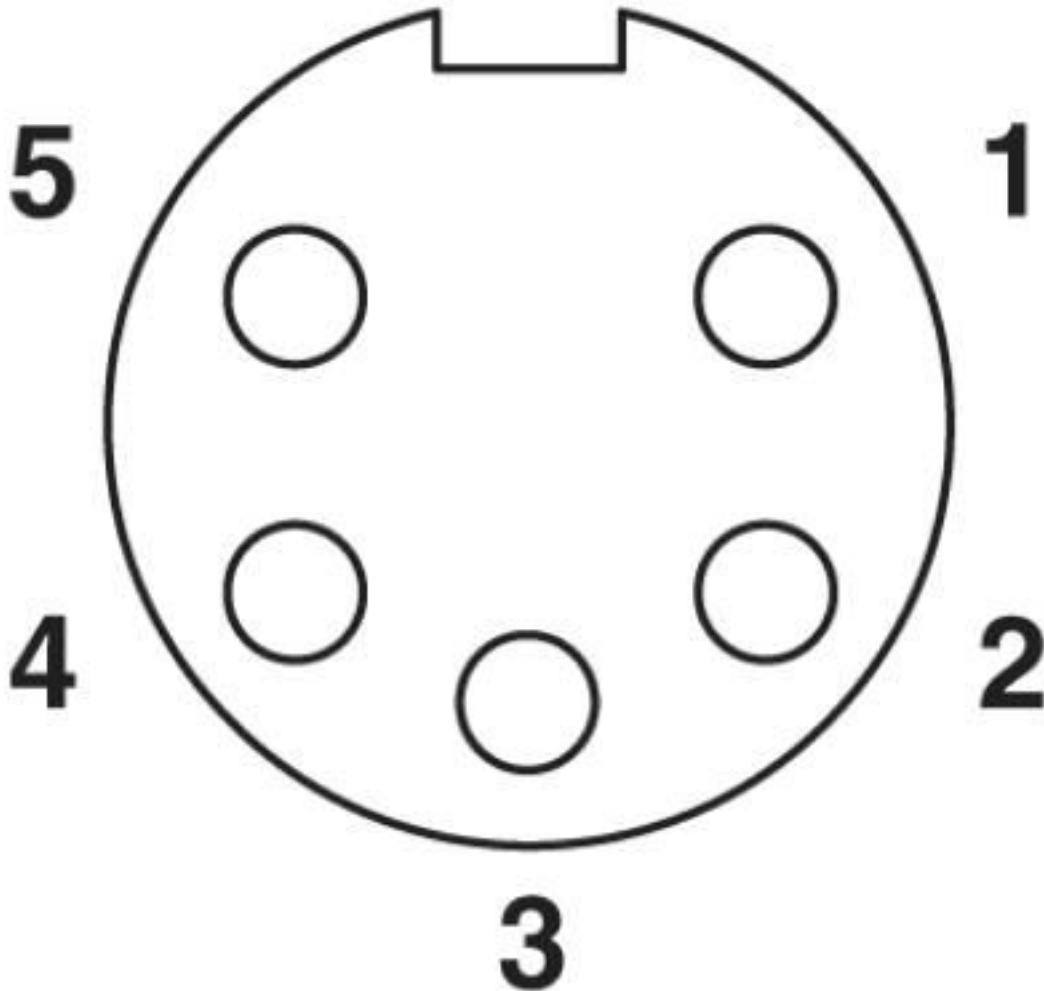

Pin assignment, socket, 7/8"-16UNF, 5-pos., view of female side

## Classifications

eCl@ss

eCl@ss 10.0.1	27440102
eCl@ss 4.0	27140800
eCl@ss 4.1	27140800
eCl@ss 5.0	27143400
eCl@ss 5.1	27143400
eCl@ss 6.0	27279200
eCl@ss 7.0	27440104
eCl@ss 8.0	27440104
eCl@ss 9.0	27440102

# Connector - SACC-MINFS-5CON-PG13/2,5 - 1456284

## Classifications

### ETIM

ETIM 4.0	EC002062
ETIM 5.0	EC002062
ETIM 6.0	EC002062

### UNSPSC

UNSPSC 6.01	31251501
UNSPSC 7.0901	31251501
UNSPSC 11	31251501
UNSPSC 12.01	31251501
UNSPSC 13.2	39121413
UNSPSC 18.0	39121413
UNSPSC 19.0	39121413
UNSPSC 20.0	39121413
UNSPSC 21.0	39121413

## Approvals

### Approvals

#### Approvals

UL Recognized / cUL Recognized / EAC / cULus Recognized

#### Ex Approvals

### Approval details

UL Recognized		<a href="http://database.ul.com/cgi-bin/XYV/template/LISEXT/1FRAME/index.htm">http://database.ul.com/cgi-bin/XYV/template/LISEXT/1FRAME/index.htm</a>	FILE E 221474
Nominal voltage UN		600 V	
Nominal current IN		16 A	

cUL Recognized		<a href="http://database.ul.com/cgi-bin/XYV/template/LISEXT/1FRAME/index.htm">http://database.ul.com/cgi-bin/XYV/template/LISEXT/1FRAME/index.htm</a>	FILE E 221474
Nominal voltage UN		600 V	
Nominal current IN		16 A	

## Connector - SACC-MINFS-5CON-PG13/2,5 - 1456284

### Approvals

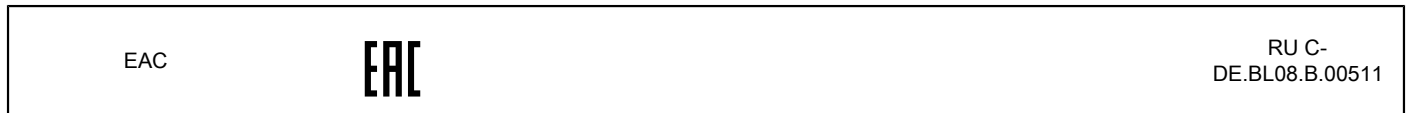

### Accessories

#### Accessories

#### Plug for cable screw gland

Screw plug - PROT-MINMS-PA-CHAIN - 1430925

7/8" sealing cap made of plastic with fixing band, for sensor cables, for 7/8" sockets



#### Screwdriver tools

Adapter insert - TSD-M SAC-BIT ADAPTER - 1212600



Adapter bit for TSD-M...torque tools, E6.3-1/4" drive with 4 mm hexagon to accommodate SAC bits

Tool - SAC BIT MIN-D25 - 1212512



Nut for assembling 7/8" connectors with a knurl diameter of 25 mm, with 4 mm hexagonal drive

#### Torque tool

## Connector - SACC-MINFS-5CON-PG13/2,5 - 1456284

### Accessories

Torque screwdriver - TSD 08 SAC - 1212597



Torque screw driver with preset torque of 0.8 Nm, with 4 mm hexagon for accommodating SAC bits, two-component handle with non-slip grip

---

Torque screwdriver - TSD-M 1,2NM - 1212224



Torque screw driver, accuracy as per EN ISO 6789 standard, adjustable from 0.3 - 1.2 Nm

---

Phoenix Contact 2020 © - all rights reserved  
<http://www.phoenixcontact.com>

PHOENIX CONTACT GmbH & Co. KG  
Flachsmarktstr. 8  
32825 Blomberg  
Germany  
Tel. +49 5235 300  
Fax +49 5235 3 41200  
<http://www.phoenixcontact.com>

## X-ON Electronics

Largest Supplier of Electrical and Electronic Components

*Click to view similar products for [Standard Circular Connector](#) category:*

*Click to view products by [Phoenix Contact](#) manufacturer:*

Other Similar products are found below :

[5M2530B10P](#) [600259N006](#) [600273N007](#) [6134-336-13149](#) [6134-337-11149](#) [6134-337-2390](#) [6134-341-17149](#) [6280-4SG-516](#) [6280-7SG-3DC](#)  
[6290](#) [6291A](#) [66200A-10](#) [680-SMG](#) [681-PMG](#) [CXS3102A14S2P](#) [CXS3102A181S](#) [7271-6SG-300](#) [7282-3PG-300-CH3](#) [75-474014-05S](#) [75-](#)  
[474618-01S](#) [75-474618-04P](#) [75-474618-04S](#) [799539-000](#) [MI8-SE](#) [805-005-07NF11-19PC](#) [805-005-07NF15-7PA](#) [8280-4PG-516](#) [8280-7PG-](#)  
[519](#) [8282-5PG-519](#) [836783-1](#) [MP-4102-25P-C](#) [862256-1](#) [864019-2](#) [866857-1](#) [867865-1](#) [PT01SP-14-18P](#) [PT08P-14-5S](#) [120-1833-000](#)  
[QCM019PC2DC012B](#) [1-2069279-1](#) [121583-0217](#) [121667-0020](#) [129591AU](#) [1000B BULK](#) [RD10A16-19-P6CS051/1](#) [RD10A20-31-](#)  
[P8CS051/1](#) [RD16A14-12-S6CS051/2](#) [1301240290](#) [1301240347](#) [1301860202](#) [1301240268](#)