

Double valve connector adapter - SAC-MS/0,1-116/2XA-1L-Z SCO - 1458101

Please be informed that the data shown in this PDF Document is generated from our Online Catalog. Please find the complete data in the user's documentation. Our General Terms of Use for Downloads are valid (<http://phoenixcontact.com/download>)



Double valve connector adapter, npn, 4-position, PUR/PVC, black RAL 9005, Plug straight M12 SPEEDCON, coding: A, on Valve connector A, with 1 LED, connected with Z diode and Valve connector A, with 1 LED, connected with Z diode, valve connector spacing: 0.1 m

Your advantages

- ✓ Easy and safe: 100% electrically tested plug-in components
- ✓ Robust valve connector with Zener diode as protective circuit
- ✓ Efficient: control valves with two connections via a single connecting cable
- ✓ Convenient: increased machine availability thanks to quick and easy diagnostics

Key Commercial Data

Packing unit	1 pc
GTIN	 4 046356 638524
GTIN	4046356638524

Technical data

Dimensions

Valve connector distance	0.1 m
Central screw valve connector	M3 x 29

Ambient conditions

Ambient temperature (operation)	-25 °C ... 85 °C (valve plug)
Degree of protection	IP65
	IP67

General

Rated current at 40°C	4 A
Rated voltage	24 V AC
	24 V DC

Double valve connector adapter - SAC-MS/0,1-116/2XA-1L-Z SCO - 1458101

Technical data

General

Number of positions	4
Insulation resistance	≥ 100 MΩ
Coding	A - standard
Standards/regulations	M12 connector IEC 61076-2-101 Valve connector EN 175301-803
Signal type/category	npn
Status display	1 LED
Protective circuit/component	Z diode
Pulse power W_{max}	40 W (at 100 μs square-wave pulse)
Terminal voltage	70 V (at 2 mA constant current)
Reverse voltage	50 V
Overvoltage category	II
Degree of pollution	3
Insertion/withdrawal cycles	50 (valve plug)
Torque	0.6 Nm (valve plug)

Material

Flammability rating according to UL 94	HB
Contact material	CuSn
Contact surface material	Ni/Au
Contact carrier material	PA 6.6
Valve plug contact material	CuSn
Valve plug contact surface material	Sn
Valve plug contact insert material	PA 6.6
Material housing valve plug	TPU
Material, knurls	Zinc die-cast, nickel-plated
Sealing material	TPU (Seal molded)

Standards and Regulations

Standards/specifications	M12 connector IEC 61076-2-101 Valve connector EN 175301-803
Flammability rating according to UL 94	HB

Cable

Cable type	PUR/PVC, 0.75 mm ² , black
Cable type (abbreviation)	116
Cable abbreviation	LiYY11Y
UL AWM style	20549
Conductor cross section	3x 0.75 mm ²
AWG signal line	18
Conductor structure signal line	24x 0.20 mm

Double valve connector adapter - SAC-MS/0,1-116/2XA-1L-Z SCO - 1458101

Technical data

Cable

Core diameter including insulation	1.7 mm ±0.05 mm
Wire colors	black 1, black 2, green/yellow
Overall twist	3 wires, twisted
External sheath, color	black RAL 9005
External cable diameter D	5.8 mm ±0.2 mm
Minimum bending radius, flexible installation	10 x D
Number of bending cycles	1000000
Traversing rate	2 m/s
Acceleration	2.5 m/s ²
Outer sheath, material	PUR
Material, inner sheath	PVC
Material conductor insulation	PVC
Conductor material	Bare Cu litz wires
Insulation resistance	≥ 20 MΩ*km
Conductor resistance	26 Ω/km (at 20 °C)
Nominal voltage, cable	300 V
Test voltage, cable	1200 V
Special properties	flexible
Flame resistance	DIN VDE 0482
	DIN EN 50265-2-1
	in acc. with UL FT-2
Other resistance	Low adhesion
Ambient temperature (operation)	-40 °C ... 80 °C (cable, fixed installation)
	-5 °C ... 80 °C (cable, flexible installation)

Environmental Product Compliance

REACH SVHC	Lead 7439-92-1
China RoHS	Environmentally Friendly Use Period = 50 years
	For details about hazardous substances go to tab "Downloads", Category "Manufacturer's declaration"

Drawings

Double valve connector adapter - SAC-MS/0,1-116/2XA-1L-Z SCO - 1458101

Schematic diagram

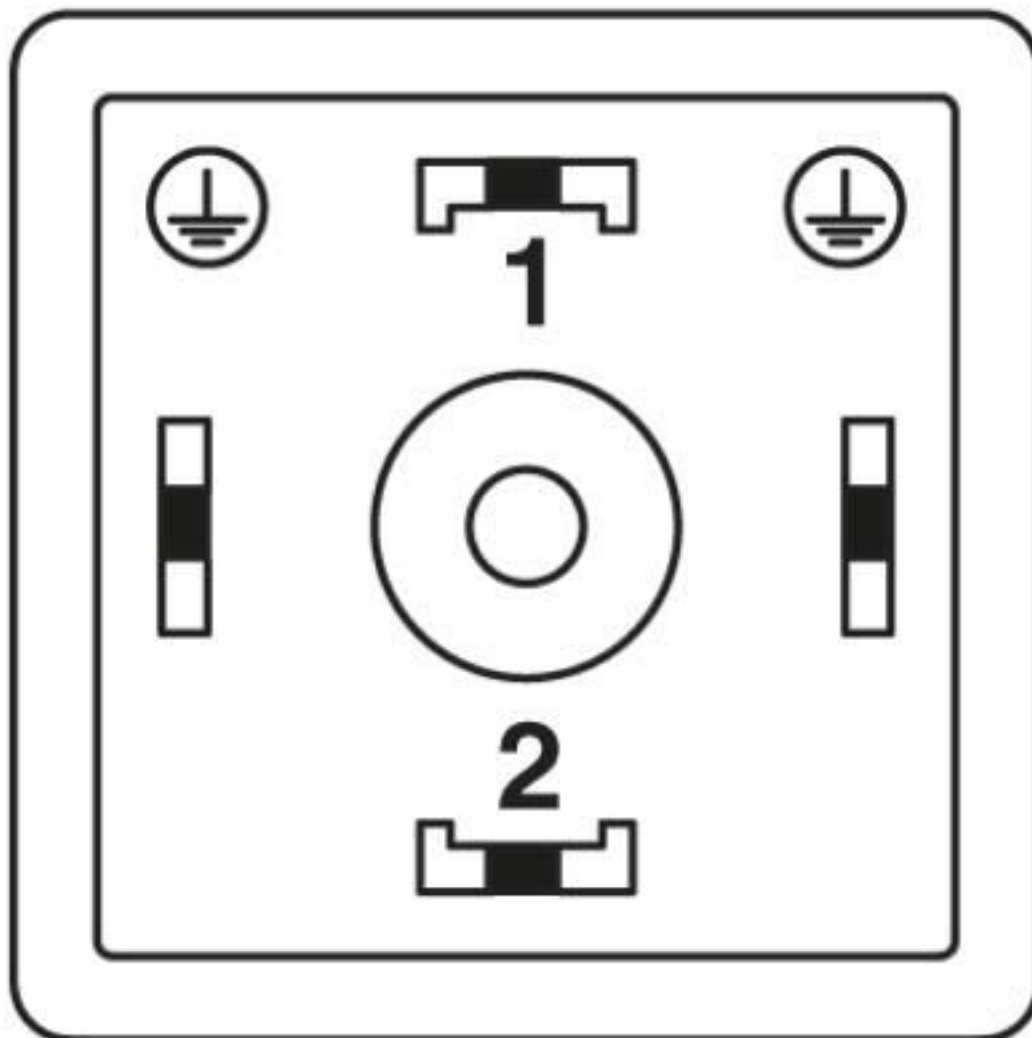

Valve connector pin assignment, type A

Double valve connector adapter - SAC-MS/0,1-116/2XA-1L-Z SCO - 1458101

Dimensional drawing

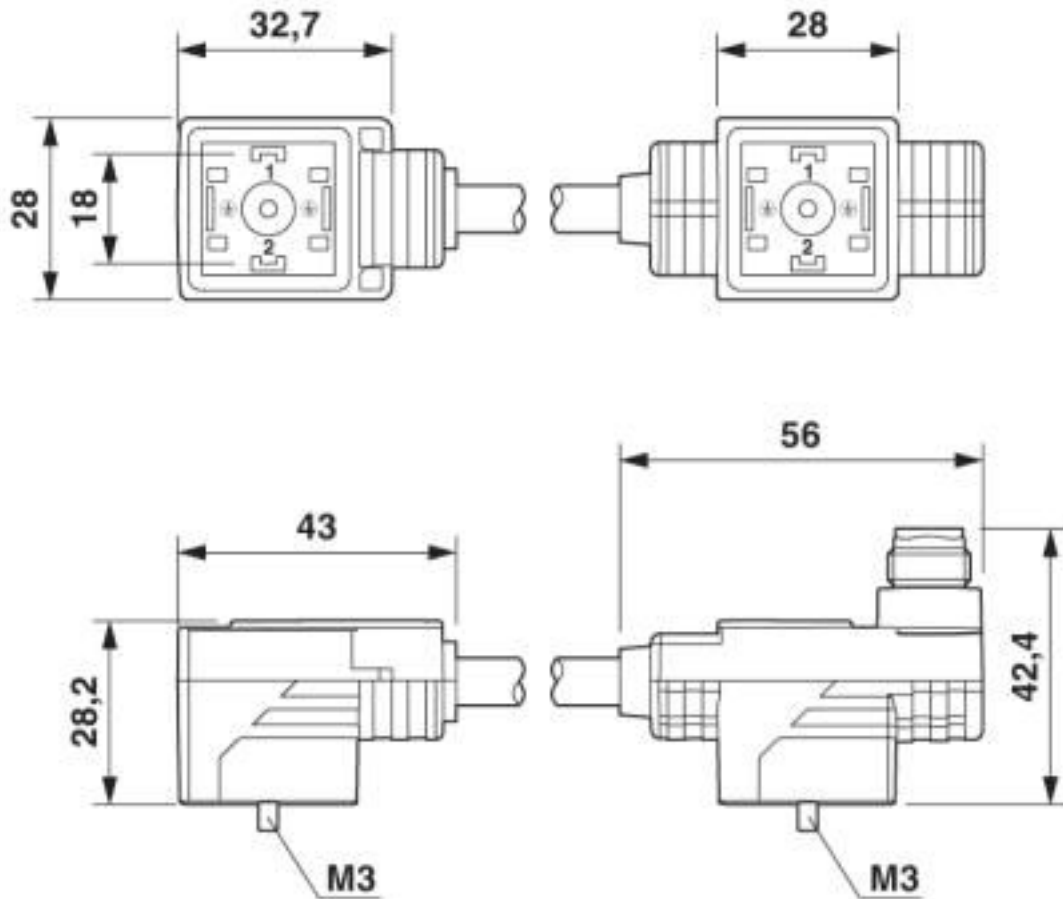

Double valve connector, 2x type A

Double valve connector adapter - SAC-MS/0,1-116/2XA-1L-Z SCO - 1458101

Dimensional drawing

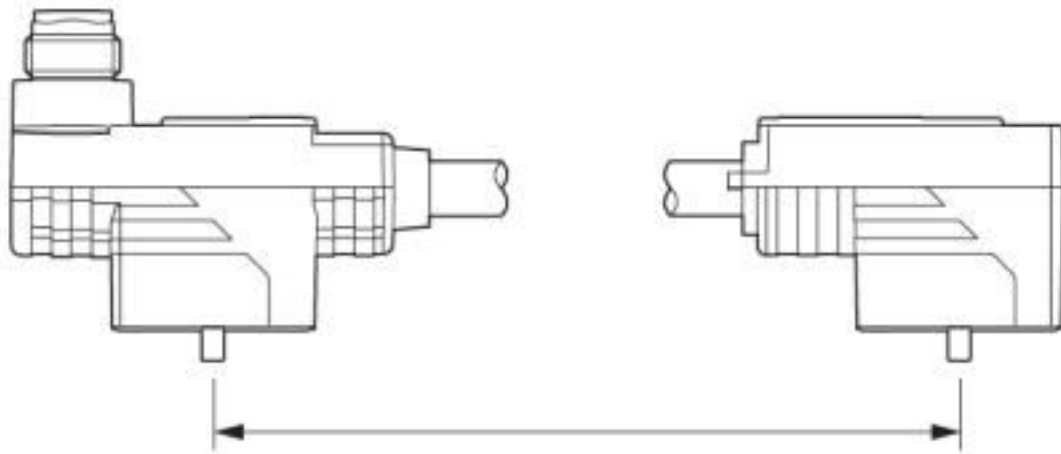

Valve connector spacing

Circuit diagram

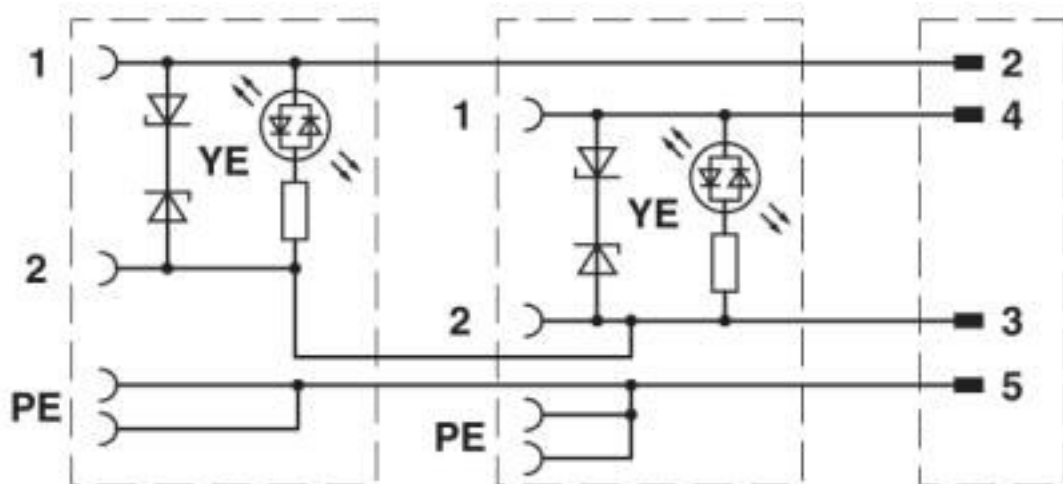

Contact assignment of the double-valve connector

Double valve connector adapter - SAC-MS/0,1-116/2XA-1L-Z SCO - 1458101

Cable cross section



PUR/PVC, 0.75 mm², black [116]

Classifications

eCl@ss

eCl@ss 10.0.1	27060312
eCl@ss 4.0	27060300
eCl@ss 4.1	27060300
eCl@ss 5.0	27061800
eCl@ss 5.1	27061800
eCl@ss 6.0	27279200
eCl@ss 7.0	27279218
eCl@ss 8.0	27279218
eCl@ss 9.0	27060312

Double valve connector adapter - SAC-MS/0,1-116/2XA-1L-Z SCO - 1458101

Classifications

ETIM

ETIM 4.0	EC001855
ETIM 5.0	EC001855
ETIM 6.0	EC001855
ETIM 7.0	EC001855

UNSPSC

UNSPSC 6.01	31251501
UNSPSC 7.0901	31251501
UNSPSC 11	31251501
UNSPSC 12.01	31251501
UNSPSC 13.2	31251501
UNSPSC 19.0	31251501
UNSPSC 20.0	31251501
UNSPSC 21.0	31251501

Approvals

Approvals

Approvals

CSAus / EAC / EAC

Ex Approvals

Approval details

CSAus		http://www.csagroup.org/services-industries/product-listing/	13631
Nominal voltage UN	24 V		
Nominal current IN	4 A		

EAC		RU C- DE.BL08.B.00286
-----	---	--------------------------

Double valve connector adapter - SAC-MS/0,1-116/2XA-1L-Z SCO - 1458101

Approvals

EAC		RU C- DE.BL08.B.00511
-----	---	--------------------------

Accessories

Accessories

Conductor marking

Insert label - PABA WH/23 - 1013779



Insert label, Strip, white, unlabeled, can be labeled with: CMS-P1-PLOTTER, mounting type: thread on, cable diameter range: 1.5 ... 35 mm, lettering field size: 23 x 4 mm, Number of individual labels: 20

Insert label - PABA YE/23 - 1013782



Insert label, Strip, yellow, unlabeled, can be labeled with: CMS-P1-PLOTTER, mounting type: thread on, cable diameter range: 1.5 ... 35 mm, lettering field size: 23 x 4 mm, Number of individual labels: 20

Marker pen

Marker pen - B-STIFT - 1051993



Marker pen, for manual labeling of unprinted Zack strips, smear-proof and waterproof, line thickness 0.5 mm

Screwdriver tools

Screw insert - SF-BIT-PH 1-70 - 1212582



Screw bit, PH crosshead, E6.3-1/4" drive, size: PH 1 x 70 mm, hardened, suitable for holder according to DIN 3126-F6.3/ISO 1173

Double valve connector adapter - SAC-MS/0,1-116/2XA-1L-Z SCO - 1458101

Accessories

Sensor/actuator cable

Connecting cable - SAC-4P-FS SCO V/.../... - 1406704



Connecting cable, 4-position, Variable cable type, free cable end, on Socket straight M12 SPEEDCON, coding: A, cable length: Free input (0.2 ... 40.0 m), For double valve plug adapters

Torque tool

Torque screwdriver - TSD-M 1,2NM - 1212224



Torque screw driver, accuracy as per EN ISO 6789 standard, adjustable from 0.3 - 1.2 Nm

Phoenix Contact 2020 © - all rights reserved
<http://www.phoenixcontact.com>

PHOENIX CONTACT GmbH & Co. KG
Flachsmarktstr. 8
32825 Blomberg
Germany
Tel. +49 5235 300
Fax +49 5235 3 41200
<http://www.phoenixcontact.com>

X-ON Electronics

Largest Supplier of Electrical and Electronic Components

Click to view similar products for [Sensor Cables / Actuator Cables](#) category:

Click to view products by [Phoenix Contact](#) manufacturer:

Other Similar products are found below :

[60963](#) [60964](#) [703000D02F2002](#) [703001D02F0602](#) [703001D02F300](#) [704000D02F120](#) [773032K02F030](#) [802027107404-1](#) [802027213811-1](#)
[804001A09M150](#) [805001A09M0502](#) [84914-0235](#) [84914-0237](#) [885030A09M020](#) [8R4J30E03C3003](#) [1200651332](#) [1200651713](#) [1200660844](#)
[1200660845](#) [1200661173](#) [1200680071](#) [1200720053](#) [1200720081](#) [1200720099](#) [1200720217](#) [1200800231](#) [1200860125](#) [1200870123](#)
[1200980102](#) [1200650267](#) [1200650298](#) [1200660183](#) [1200660782](#) [1200660849](#) [1200661295](#) [1200661297](#) [1200661342](#) [1200661343](#)
[1200670080](#) [1200670220](#) [1200680331](#) [1200720252](#) [1200730184](#) [1200860344](#) [1200870359](#) [1200870643](#) [1200980008](#) [1200980031](#)
[1210502211](#) [1210400542](#)