

Flush-type connector - SACC-E-M12FS-4CON-M16/0,5 VA - 1458855

Please be informed that the data shown in this PDF Document is generated from our Online Catalog. Please find the complete data in the user's documentation. Our General Terms of Use for Downloads are valid (<http://phoenixcontact.com/download>)



Sensor/actuator flush-type socket, 4-pos. M12, A-coded, front/screw mounting with M16 thread, with 0.5 m TPE litz wire, 4 x 0.34 mm², stainless steel version

Your advantages

- ✓ Pre-assembled with litz wires for immediate use
- ✓ Customer-specific assemblies and litz wire lengths available
- ✓ Sealed on the litz wire side for optimum leak-tightness
- ✓ All standard pin assignments and codings for signal, data, and power transmission with a uniform design-in design
- ✓ For high transmission safety: shield connection to the housing with optional EMC nut



Key Commercial Data

Packing unit	1 pc
GTIN	
GTIN	4046356655507

Technical data

Dimensions

Length of cable	0.5 m
-----------------	-------

Ambient conditions

Ambient temperature (operation)	-25 °C ... 85 °C (Plug / socket)
	-40 °C ... 85 °C (without mechanical actuation)
Degree of protection	IP65/IP67/IP69/IP69K

General

Note	The electrical and mechanical data specified assume that the connector pair is correctly locked and mounted. If the connector is unlocked and if there is a danger of contamination, the connector must be sealed using a protective cap > IP54. Influences arising from litz wires, cables or PCB assembly must also be taken into consideration.
Rated current at 40°C	4 A

Flush-type connector - SACC-E-M12FS-4CON-M16/0,5 VA - 1458855

Technical data

General

Rated voltage	250 V
Rated surge voltage	2.5 kV
Number of positions	4
Insulation resistance	≥ 100 MΩ
Standards/regulations	M12 connector IEC 61076-2-101
Signal type/category	Universal
Status display	No
Overvoltage category	II
Degree of pollution	3
Connection method	Individual wires
Insertion/withdrawal cycles	> 100
Torque	3 Nm ... 4 Nm (Installation-side)
Mounting type	Front mounting M16 x 1.5

Material

Flammability rating according to UL 94	V0
Contact material	CuZn
Contact surface material	Ni/Au
Contact carrier material	PA 6.6
Material, knurls	Stainless steel
Sealing material	FKM

Cable

Cable type	TPE litz wire
Conductor cross section	0.34 mm ²
AWG signal line	22
Conductor structure signal line	7x 0.25 mm
Core diameter including insulation	1.2 mm ±0.07 mm
Thickness, insulation	0.21 mm (Core insulation)
Wire colors	brown, white, blue, black
Material conductor insulation	TPE
Conductor material	Tin-plated Cu litz wires
Standards/specifications	M12 connector IEC 61076-2-101
Insulation resistance	≥ 20 MΩ*km
Conductor resistance	≤ 57.6 mΩ/m
Nominal voltage, cable	300 V
Test voltage, cable	2000 V AC
Ambient temperature (operation)	-40 °C ... 85 °C (cable, fixed installation)
	-25 °C ... 85 °C (cable, flexible installation)

Standards and Regulations

Standards/specifications	M12 connector IEC 61076-2-101
--------------------------	-------------------------------

Flush-type connector - SACC-E-M12FS-4CON-M16/0,5 VA - 1458855

Technical data

Standards and Regulations

Flammability rating according to UL 94	V0
Safety note	WARNING: The connectors may not be plugged in or disconnected under load. Ignoring the warning or improper use may damage persons and/or property.
	<ul style="list-style-type: none"> • WARNING: Commission properly functioning products only. The products must be regularly inspected for damage. Decommission defective products immediately. Replace damaged products. Repairs are not possible.
	<ul style="list-style-type: none"> • WARNING: Only electrically qualified personnel may install and operate the product. They must observe the following safety notes. The qualified personnel must be familiar with the basics of electrical engineering. They must be able to recognize and prevent danger. The relevant symbol on the packaging indicates that only personnel familiar with electrical engineering are allowed to install and operate the product.
	<ul style="list-style-type: none"> • The products are suitable for applications in plant, controller, and electrical device engineering.
	<ul style="list-style-type: none"> • When operating the connectors in outdoor applications, they must be separately protected against environmental influences.
	<ul style="list-style-type: none"> • Assembled products may not be manipulated or improperly opened.
	<ul style="list-style-type: none"> • Only use mating connectors that are specified in the technical data of the standards listed (e.g. the ones listed in the product accessories online at phoenixcontact.com/products).
	<ul style="list-style-type: none"> • When using the product in direct connection with third-party manufacturers, the user is responsible.
	<ul style="list-style-type: none"> • For operating voltages > 50 V AC, conductive connector housings must be grounded
	<ul style="list-style-type: none"> • Ensure that when laying the cable, the tensile load on the connectors does not exceed the upper limit specified in the standards.
	<ul style="list-style-type: none"> • Observe the corresponding technical data. You will find information: <ul style="list-style-type: none"> o On the product o On the packing label o In the supplied documentation o Online at phoenixcontact.com/products under the product
	<ul style="list-style-type: none"> • Only use tools recommended by Phoenix Contact
	<ul style="list-style-type: none"> • Use a protective cap to protect connectors that are not in use. The suitable accessories are available online in the accessory section of the product at phoenixcontact.com/products
	<ul style="list-style-type: none"> • Ensure that the protective or functional ground has been properly connected.
	<ul style="list-style-type: none"> • VDE 0100/1.97 § 411.1.3.2 and DIN EN 60 204/11.98 § 14.1.3 are applicable when combining several circuits in a cable and/or connector
	<ul style="list-style-type: none"> • The connector warms up in normal operation. Depending on the ambient conditions, the surface of the connector can continue to warm up. In this case, the user is responsible for posting warnings (e.g. DIN EN ISO 13732-1:2008-12).

Environmental Product Compliance

China RoHS	Environmentally friendly use period: unlimited = EFUP-e
	No hazardous substances above threshold values

Drawings

Flush-type connector - SACC-E-M12FS-4CON-M16/0,5 VA - 1458855

Diagram

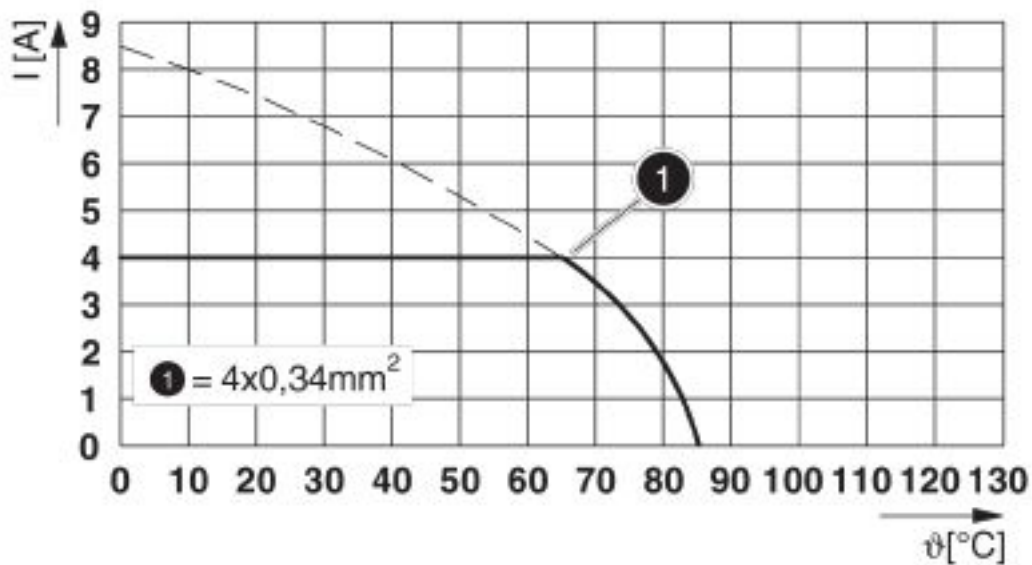

I = current strength, T = ambient temperature

Dimensional drawing

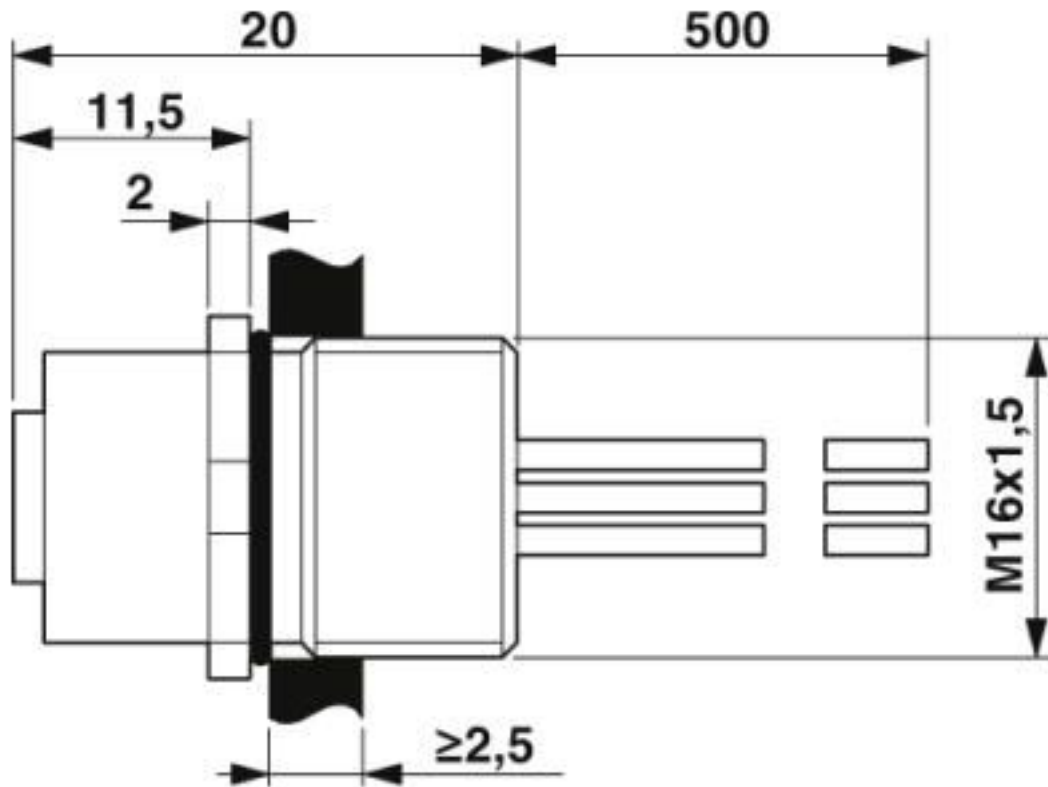

M12 flush-type plug

Flush-type connector - SACC-E-M12FS-4CON-M16/0,5 VA - 1458855

Dimensional drawing

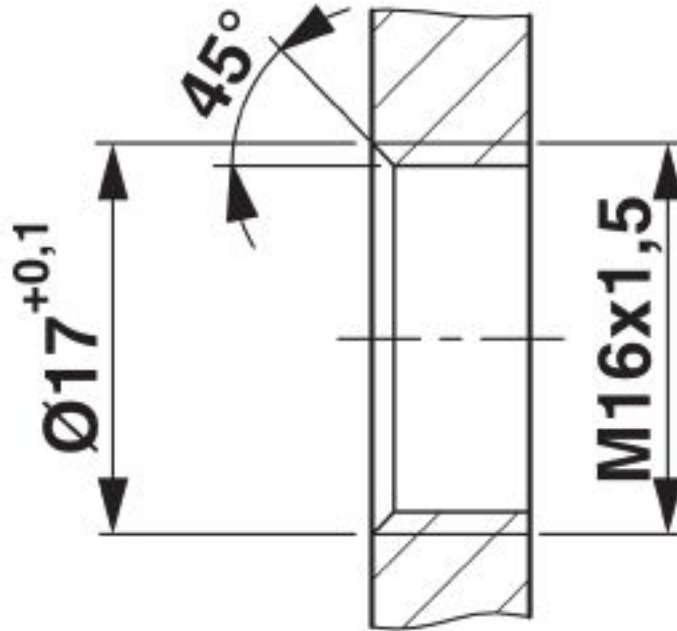

Housing cutout for M16 fastening thread, mounting panel with thread

Circuit diagram

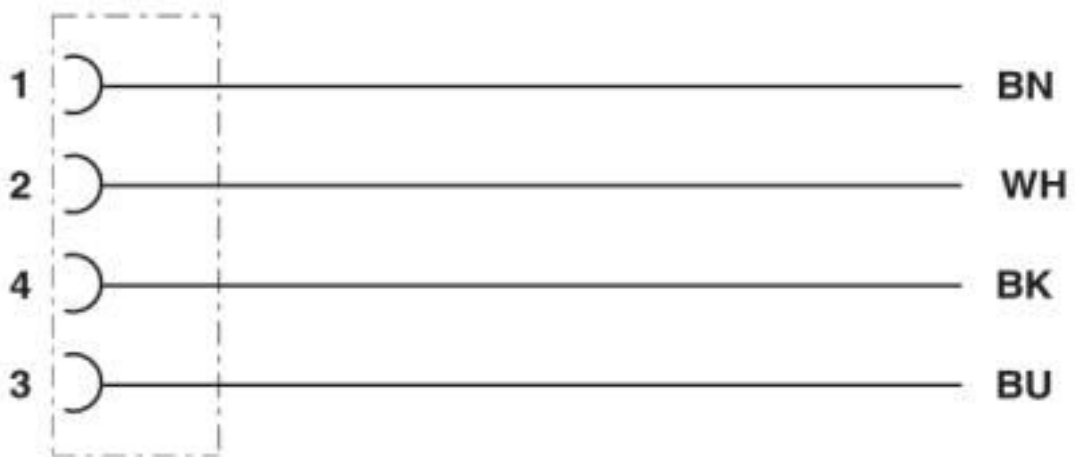

Contact assignment of the M12 socket

Flush-type connector - SACC-E-M12FS-4CON-M16/0,5 VA - 1458855

Schematic diagram

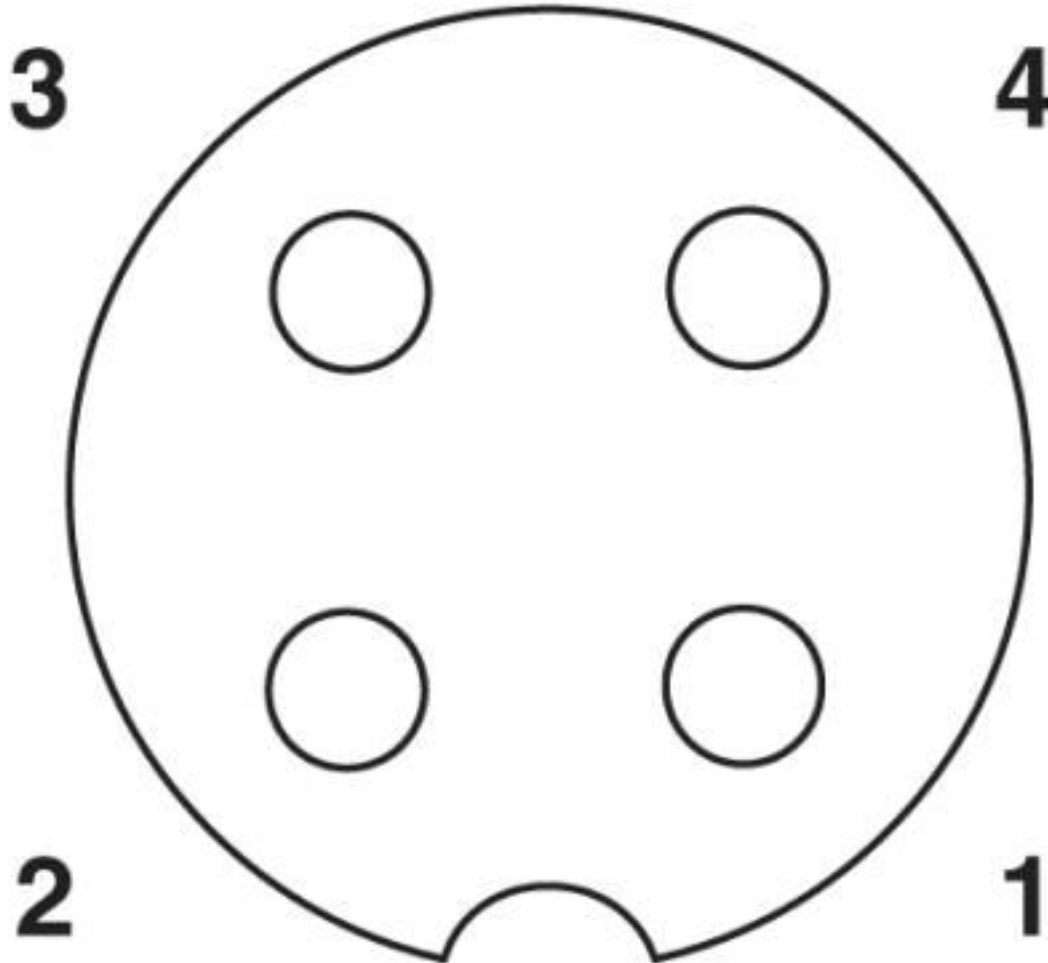

Pin assignment M12 socket, 4-pos., A-coded, view female side

Classifications

eCl@ss

eCl@ss 10.0.1	27440102
eCl@ss 4.0	27140800
eCl@ss 4.1	27140800
eCl@ss 5.0	27143400
eCl@ss 5.1	27143400
eCl@ss 6.0	27279200
eCl@ss 7.0	27440103
eCl@ss 8.0	27440103
eCl@ss 9.0	27440102

Flush-type connector - SACC-E-M12FS-4CON-M16/0,5 VA - 1458855

Classifications

ETIM

ETIM 3.0	EC002061
ETIM 4.0	EC002062
ETIM 5.0	EC002061
ETIM 6.0	EC002061

UNSPSC

UNSPSC 6.01	31251501
UNSPSC 7.0901	31251501
UNSPSC 11	31251501
UNSPSC 12.01	31251501
UNSPSC 13.2	39121413
UNSPSC 18.0	39121413
UNSPSC 19.0	39121413
UNSPSC 20.0	39121413
UNSPSC 21.0	39121413

Approvals

Approvals

Approvals

UL Recognized / EAC / cULus Recognized

Ex Approvals

Approval details

UL Recognized		http://database.ul.com/cgi-bin/XYV/template/LISEXT/1FRAME/index.htm	FILE E 118976
Nominal voltage UN	250 V		
Nominal current IN	4 A		
mm ² /AWG/kcmil	22		

EAC		B.01687
-----	---	---------

Flush-type connector - SACC-E-M12FS-4CON-M16/0,5 VA - 1458855

Approvals

cULus Recognized		http://database.ul.com/cgi-bin/XYV/template/LISEXT/1FRAME/index.htm E221474-20140616
Nominal voltage UN		250 V
Nominal current IN		4 A
mm ² /AWG/kcmil		22-20

Accessories

Accessories

Circular connectors (device side)

Flat nut - SACC-M16-NUT-VA - 1404983



Flat nut with M16 thread

Plug for cable screw gland

Screw plug - PROT-M12 - 1680539



An M12 screw plug for the unoccupied M12 sockets of the sensor/actuator cable, boxes and flush-type connectors

Screw plug - PROT-M12 SH - 1503302



An M12 screw plug for the unoccupied M12 sockets of the shielded sensor/actuator cable, boxes and flush-type connectors

Screw plug - PROT-M12 FB - 1555538



M12 high-grade steel screw plug, for unoccupied M12 sockets of the sensor/actuator cables, boxes and flush-type connectors for the food industry

Flush-type connector - SACC-E-M12FS-4CON-M16/0,5 VA - 1458855

Accessories

Seal

Flat gasket - SACC-M16-SEAL CLM - 1430394



M16 flat gasket, for rear mounting of M12 flush-type connectors with M16 fastening thread

Phoenix Contact 2020 © - all rights reserved
<http://www.phoenixcontact.com>

PHOENIX CONTACT GmbH & Co. KG
Flachsmarktstr. 8
32825 Blomberg
Germany
Tel. +49 5235 300
Fax +49 5235 3 41200
<http://www.phoenixcontact.com>

X-ON Electronics

Largest Supplier of Electrical and Electronic Components

Click to view similar products for [Sensor Cables / Actuator Cables](#) category:

Click to view products by [Phoenix Contact](#) manufacturer:

Other Similar products are found below :

[60963](#) [60964](#) [703000D02F2002](#) [703001D02F0602](#) [703001D02F300](#) [704000D02F120](#) [773032K02F030](#) [802027107404-1](#) [802027213811-1](#)
[804001A09M150](#) [805001A09M0502](#) [84914-0235](#) [84914-0237](#) [885030A09M020](#) [8R4J30E03C3003](#) [1200651332](#) [1200651713](#) [1200660844](#)
[1200660845](#) [1200661173](#) [1200680071](#) [1200720053](#) [1200720081](#) [1200720099](#) [1200720217](#) [1200800231](#) [1200860125](#) [1200870123](#)
[1200980102](#) [1200650267](#) [1200650298](#) [1200660183](#) [1200660782](#) [1200660849](#) [1200661295](#) [1200661297](#) [1200661342](#) [1200661343](#)
[1200670080](#) [1200670220](#) [1200680331](#) [1200720252](#) [1200730184](#) [1200860344](#) [1200870359](#) [1200870643](#) [1200980008](#) [1200980031](#)
[1210502211](#) [1210400542](#)