

Sensor/actuator box - SACB- 4/3-L-M12-M8 - 1516234

Please be informed that the data shown in this PDF Document is generated from our Online Catalog. Please find the complete data in the user's documentation. Our General Terms of Use for Downloads are valid (<http://phoenixcontact.com/download>)



Sensor/actuator box, application: Standard, connection method: M8 socket Metal, number of slots: 4, number of positions: 3, coding: A - standard, slot assignment: single, status display: yes, pnp; master cable connection: M12 plug connection 90°, shielding: no

Your advantages

- Safety in the field, thanks to molded housing and high degree of protection
- Flexible, distributed bundling of signals in one master cable
- Convenient: increased machine availability thanks to quick and easy diagnostics

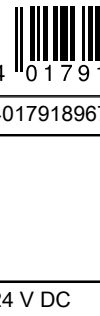

Key Commercial Data

Packing unit	1 pc
GTIN	 4 017918 967161
GTIN	4017918967161

Technical data

General

Rated voltage	24 V DC
Max. operating voltage U_{max}	30 V DC
Current carrying capacity per I/O signal	2 A
Current carrying capacity per slot	2 A
Total rated current	4 A
Number of positions	3
Number of slots	4
Flammability rating according to UL 94	V0
Sensor/actuator connection system	M8 socket
Note	NOTE: Observe the permissible bending radii when laying conductors, since the degree of protection may be put in jeopardy if the bending forces are too high. Alleviate mechanical loads upstream of the connector, e.g. by using cable ties.
	Unused slots are to be sealed off prior to commissioning. Suitable sealing elements are to be found under "Accessories".

Sensor/actuator box - SACB- 4/3-L-M12-M8 - 1516234

Technical data

Ambient conditions

Degree of protection	IP65
	IP67
Ambient temperature (operation)	-30 °C ... 80 °C

Local diagnostics function

Local diagnostics	Supply voltage per module Green LED
	Status display I/O Yellow LED

Master cable data/connection data

Connection method	M12 plug connection
Tightening torque - master cable - plug connection	0.4 Nm
Tightening torque slot sensor/actuator cable	0.2 Nm

Insulation material

Housing material	PBT
Material of the moulding mass	PUR
Contact material	CuSn
Contact surface material	Ni/Au
Contact carrier material	PA
Material of contact, master cable side	CU alloy
Material of contact surface, master cable side	Gold-plated
Material of threaded sleeve	Cu alloy
Material of threaded sleeve surface	Nickel-plated
O-ring material	NBR

Pin assignment

Slot/position = Wire color or connection	1 / 4 (A) = 1
	2 / 4 (A) = 2
	3 / 4 (A) = 3
	4 / 4 (A) = 4
	1-4 / 1 (+ 24 V) = 5
	1-4 / 3 (0 V) = 7

Standards and Regulations

Standards/specifications	M12 connector IEC 61076-2-101
	M8 connector IEC 61076-2-104
Connection in acc. with standard	CUL
Flammability rating according to UL 94	V0

Environmental Product Compliance

REACH SVHC	Lead 7439-92-1
China RoHS	Environmentally Friendly Use Period = 50 years
	For details about hazardous substances go to tab "Downloads", Category "Manufacturer's declaration"

Sensor/actuator box - SACB- 4/3-L-M12-M8 - 1516234

Drawings

Schematic diagram

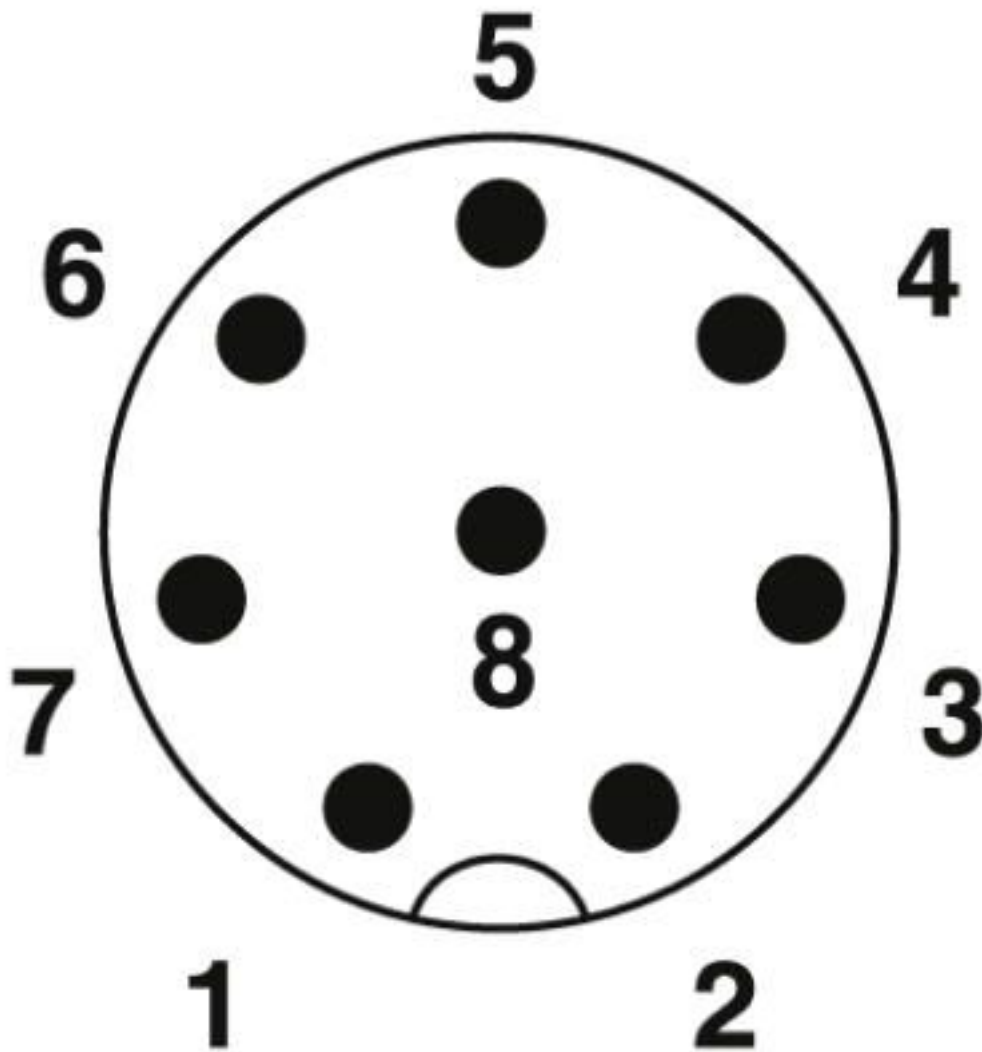

Connector pin assignment for M12 plug-in connection, 8-pos.

Sensor/actuator box - SACB- 4/3-L-M12-M8 - 1516234

Dimensional drawing

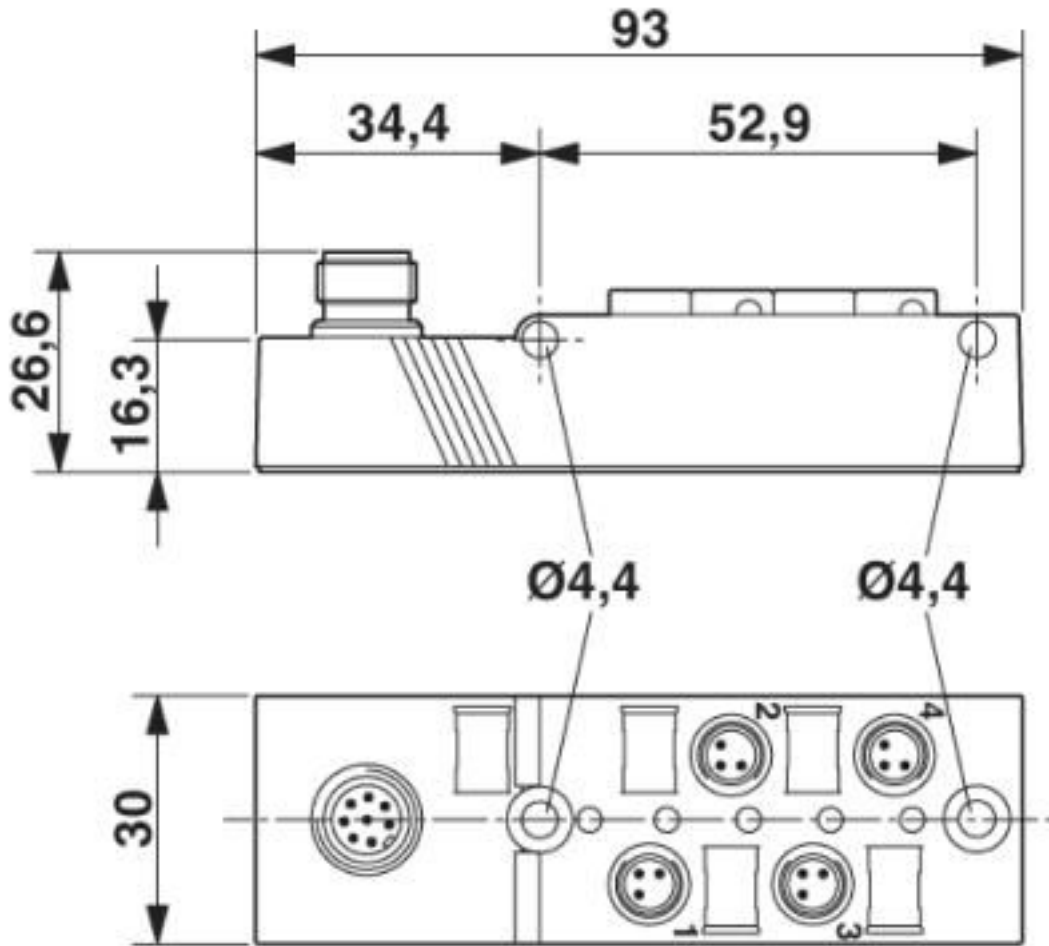

Circuit diagram

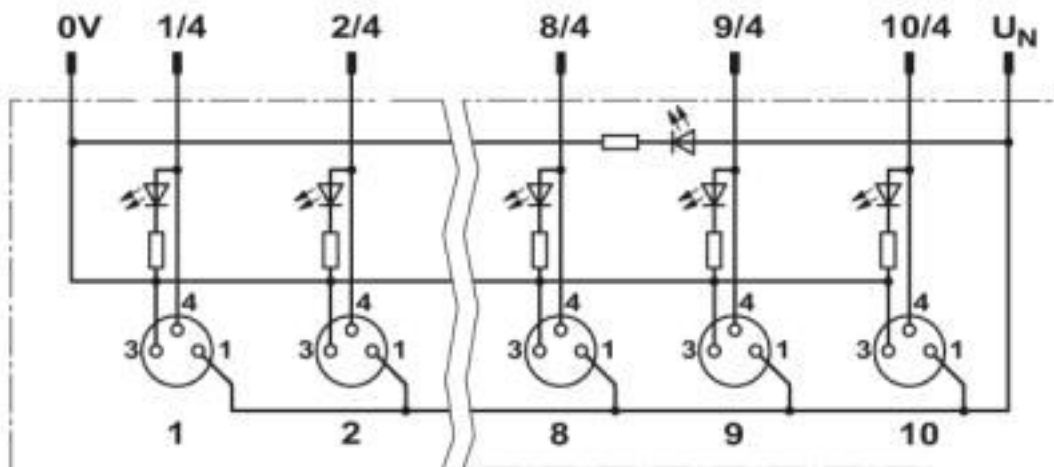

Further information can be found in the connection assignment section

Sensor/actuator box - SACB- 4/3-L-M12-M8 - 1516234

Schematic diagram

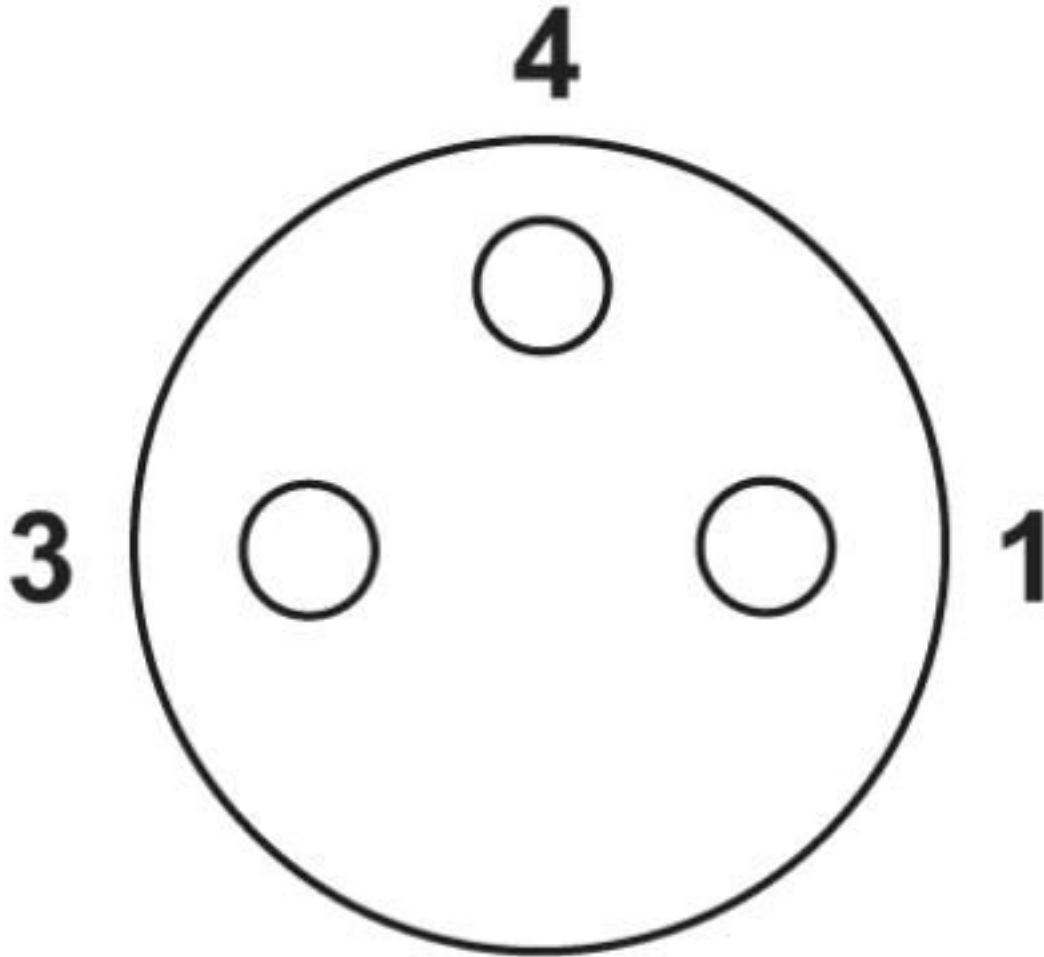

Pin assignment M8 socket, 3-pos.

Classifications

eCl@ss

eCl@ss 10.0.1	27440111
eCl@ss 4.0	27140800
eCl@ss 4.1	27140800
eCl@ss 5.0	27143400
eCl@ss 5.1	27250300
eCl@ss 6.0	27279200
eCl@ss 7.0	27279219
eCl@ss 8.0	27279219
eCl@ss 9.0	27440108

Sensor/actuator box - SACB- 4/3-L-M12-M8 - 1516234

Classifications

ETIM

ETIM 2.0	EC000200
ETIM 3.0	EC001856
ETIM 4.0	EC002585
ETIM 5.0	EC002585
ETIM 6.0	EC002585
ETIM 7.0	EC002585

UNSPSC

UNSPSC 6.01	31261501
UNSPSC 7.0901	31261501
UNSPSC 11	31261501
UNSPSC 12.01	31261501
UNSPSC 13.2	31251501
UNSPSC 19.0	31251501
UNSPSC 20.0	31251501
UNSPSC 21.0	31251501

Approvals

Approvals

Approvals

UL Recognized / cUL Recognized / EAC / EAC / cULus Recognized

Ex Approvals

Approval details

UL Recognized		http://database.ul.com/cgi-bin/XYV/template/LISEXT/1FRAME/index.htm	FILE E 118976
Nominal voltage UN		24 V	

cUL Recognized		http://database.ul.com/cgi-bin/XYV/template/LISEXT/1FRAME/index.htm	FILE E 118976
Nominal voltage UN		24 V	

Sensor/actuator box - SACB- 4/3-L-M12-M8 - 1516234

Approvals

EAC		EAC-Zulassung
-----	--	---------------

EAC		RU C- DE.BL08.B.00511
-----	--	--------------------------

cULus Recognized		
------------------	--	--

Accessories

Accessories

Labeled terminal marker

Marker for terminal blocks - UC-TMF 10 CUS - 0824662



Marker for terminal blocks, can be ordered: by sheet, white, labeled according to customer specifications, mounting type: snap into flat marker groove, for terminal block width: 10.2 mm, lettering field size: 9.6 x 5.1 mm, Number of individual labels: 48

Marker for terminal blocks - UCT-TMF 10 CUS - 0829679



Marker for terminal blocks, can be ordered: by sheet, white, labeled according to customer specifications, mounting type: snap into flat marker groove, for terminal block width: 10.2 mm, lettering field size: 9.4 x 4.7 mm, Number of individual labels: 36

Marker for terminal blocks - UC-TMF 10 YE CUS - 0824668



Marker for terminal blocks, can be ordered: by sheet, yellow, labeled according to customer specifications, mounting type: snap into flat marker groove, for terminal block width: 10.2 mm, lettering field size: 9.6 x 5.1 mm, Number of individual labels: 48

Sensor/actuator box - SACB- 4/3-L-M12-M8 - 1516234

Accessories

Marker for terminal blocks - UCT-TMF 10 YE CUS - 0829682



Marker for terminal blocks, can be ordered: by sheet, yellow, labeled according to customer specifications, mounting type: snap into flat marker groove, for terminal block width: 10.2 mm, lettering field size: 9.4 x 4.7 mm, Number of individual labels: 36

Master cable, assembled

Master cable - SAC-6P-M12FR-PURMC/ - 1520987



Master cable, application: Sensor/actuator box, connection method: M8 socket Metal, number of slots: 4, number of positions: 6, coding: A - standard, slot assignment: single, status display: No, Universal; master cable connection: M12 plug connection, PUR/PVC, cable length: 0.5 m ... 50 m, shielding: no

Master cable - SAC-6P- 5,0-PURMC/M12FR - 1407820



M12 socket, angled, 6-pos., with connected master cable, for sensor/actuator box with M8 slots, cable length: 5 m

Master cable - SAC-6P-10,0-PURMC/M12FR - 1407821



M12 socket, angled, 6-pos., with connected master cable, for sensor/actuator box with M8 slots, cable length: 10 m

Plug for cable screw gland

Screw plug - PROT-M8 - 1682540



An M8 screw plug for the unoccupied M8 sockets of the sensor/actuator cable, boxes and flush-type connectors

Protective cap

Sensor/actuator box - SACB- 4/3-L-M12-M8 - 1516234

Accessories

Sealing cap - PROT-M12 FS - 1560251



M12 sealing cap for unoccupied M12 plugs of the sensor/actuator cable, flush-type plugs and I/O devices in the field

Screwdriver tools

Tool - SAC BIT M8-D10 - 1208461



Nut for assembling M8 connectors with longitudinal knurl and a knurl diameter of 10 mm, for 4 mm hexagonal drive

Tool - SACC BIT M8-D12 - 1208474



Nut for assembling M8 connectors with longitudinal knurl and a knurl diameter of 12 mm, for 4 mm hexagonal drive

Adapter insert - TSD-M SAC-BIT ADAPTER - 1212600



Adapter bit for TSD-M...torque tools, E6.3-1/4" drive with 4 mm hexagon to accommodate SAC bits

Tool - SAC BIT M12-D15 - 1208432



Nut for assembling sensor/actuator cables with M12 connector and M12 connectors for assembly, with a knurl diameter of 15 mm, for 4 mm hexagonal drive

Terminal marking

Sensor/actuator box - SACB- 4/3-L-M12-M8 - 1516234

Accessories

Marker for terminal blocks - UC-TMF 10 - 0818124



Marker for terminal blocks, Sheet, white, unlabeled, can be labeled with: BLUEMARK ID COLOR, BLUEMARK ID, BLUEMARK CLED, PLOTMARK, CMS-P1-PLOTTER, mounting type: snap into flat marker groove, for terminal block width: 10.2 mm, lettering field size: 9.6 x 5.1 mm, Number of individual labels: 48

Marker for terminal blocks - UCT-TMF 10 - 0829204



Marker for terminal blocks, Sheet, white, unlabeled, can be labeled with: TOPMARK NEO, TOPMARK LASER, BLUEMARK ID COLOR, BLUEMARK ID, BLUEMARK CLED, THERMOMARK PRIME, THERMOMARK CARD 2.0, THERMOMARK CARD, mounting type: snap into flat marker groove, for terminal block width: 10.2 mm, lettering field size: 9.4 x 4.7 mm, Number of individual labels: 36

Marker for terminal blocks - UC-TMF 10 YE - 0818687



Marker for terminal blocks, Sheet, yellow, unlabeled, can be labeled with: BLUEMARK ID COLOR, BLUEMARK ID, BLUEMARK CLED, PLOTMARK, CMS-P1-PLOTTER, mounting type: snap into flat marker groove, for terminal block width: 10.2 mm, lettering field size: 9.6 x 5.1 mm, Number of individual labels: 48

Marker for terminal blocks - UCT-TMF 10 YE - 0829207



Marker for terminal blocks, Sheet, yellow, unlabeled, can be labeled with: TOPMARK NEO, TOPMARK LASER, BLUEMARK ID COLOR, BLUEMARK ID, BLUEMARK CLED, THERMOMARK PRIME, THERMOMARK CARD 2.0, THERMOMARK CARD, mounting type: snap into flat marker groove, for terminal block width: 10.2 mm, lettering field size: 9.4 x 4.7 mm, Number of individual labels: 36

Torque tool

Torque screwdriver - TSD 02 SAC - 1208487



Torque screwdriver, with preset torque of 0.2 Nm and 4 mm hexagonal drive for M8 connectors

Sensor/actuator box - SACB- 4/3-L-M12-M8 - 1516234

Accessories

Torque screwdriver - TSD 04 SAC - 1208429



Torque screwdriver, with preset torque of 0.4 Nm and 4 mm hexagonal drive for M12 connectors

Torque screwdriver - TSD-M 1,2NM - 1212224



Torque screw driver, accuracy as per EN ISO 6789 standard, adjustable from 0.3 - 1.2 Nm

Phoenix Contact 2020 © - all rights reserved
<http://www.phoenixcontact.com>

PHOENIX CONTACT GmbH & Co. KG
Flachsmarktstr. 8
32825 Blomberg
Germany
Tel. +49 5235 300
Fax +49 5235 3 41200
<http://www.phoenixcontact.com>

X-ON Electronics

Largest Supplier of Electrical and Electronic Components

Click to view similar products for [Circular Metric Connectors](#) category:

Click to view products by [Phoenix Contact](#) manufacturer:

Other Similar products are found below :

[600X518037X](#) [6STD15PCR99B70A](#) [8R4000A16M020](#) [8R5000A16M005](#) [1200910002](#) [1203580030](#) [1200910008](#) [1200910011](#) [1300140094](#)
[130203-0054](#) [1300140026](#) [1300150099](#) [RF-12S1N8A90DU](#) [1612618](#) [21036836414](#) [8R4006A16M010](#) [1604232](#) [1R3006A20M005](#) [RF-](#)
[12P1N8A80DU](#) [RF-12P1N8A90DU](#) [41-40011](#) [42-00006](#) [42-01015](#) [4-22279-4](#) [4-22281-1](#) [4-22284-9](#) [43-00113](#) [43-01088](#) [43-01203](#) [41-](#)
[40013](#) [42-00008](#) [43-00343](#) [43-01026](#) [43-01032](#) [43-01162](#) [43-01173](#) [43-10000](#) [XS3P-M421-2](#) [600X518050X](#) [SACC-DSI-FS-5P-PG9-L180](#)
[SC](#) [8R5006A16M020](#) [8R5006A16M005](#) [8R4000A16M010](#) [6-22279-3](#) [1605332](#) [N03FA03144](#) [1300140077](#) [43-16213](#) [43-01338](#)
[XS2RD4265](#)