

## Sensor/actuator cable - SAC-3P-MR/ 0,6-PUR/FS SCO - 1518779

Please be informed that the data shown in this PDF Document is generated from our Online Catalog. Please find the complete data in the user's documentation. Our General Terms of Use for Downloads are valid (<http://phoenixcontact.com/download>)



Sensor/actuator cable, 3-position, PUR halogen-free, black-gray RAL 7021, Plug angled M12 SPEEDCON, coding: A, on Socket straight M12 SPEEDCON, coding: A, cable length: 0.6 m

### Your advantages

- ✓ Easy and safe: 100% electrically tested plug-in components
- ✓ Save time, thanks to installation with SPEEDCON fast locking system
- ✓ Our standard: robust halogen-free PUR cable

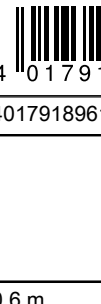

### Key Commercial Data

Packing unit	1 pc
GTIN	 4 017918 961152
GTIN	4017918961152

### Technical data

#### Dimensions

Length of cable	0.6 m
-----------------	-------

#### Ambient conditions

Ambient temperature (operation)	-25 °C ... 90 °C (Plug / socket)
Degree of protection	IP65
	IP67
	IP68

#### General

Rated current at 40°C	4 A
Rated voltage	250 V AC
	250 V DC
Number of positions	3
Insulation resistance	≥ 100 MΩ

# Sensor/actuator cable - SAC-3P-MR/ 0,6-PUR/FS SCO - 1518779

## Technical data

### General

Coding	A - standard
Standards/regulations	M12 connector IEC 61076-2-101
Status display	No
Protective circuit/component	unwired
Overvoltage category	II
Degree of pollution	3
Insertion/withdrawal cycles	≥ 100
Torque	0.4 Nm (M12 connector)

### Material

Flammability rating according to UL 94	HB
Contact material	CuSn
Contact surface material	Ni/Au
Contact carrier material	TPU GF
Material of grip body	TPU, hardly inflammable, self-extinguishing
Material, knurls	Zinc die-cast, nickel-plated
Sealing material	NBR

### Cable

Cable type	PUR halogen-free black
Cable abbreviation	Li9Y11Y
Conductor cross section	0.34 mm <sup>2</sup>
AWG signal line	22
Conductor structure signal line	42x 0.10 mm
Core diameter including insulation	1.27 mm ±0.02 mm
Thickness, insulation	≥ 0.21 mm (Core insulation)
	≥ 0.76 mm (Outer cable sheath)
Wire colors	brown, blue, black
Overall twist	3 wires, twisted
External sheath, color	black-gray RAL 7021
External cable diameter	4.40 mm
Smallest bending radius, movable installation	44 mm
Number of bending cycles	4000000
Bending radius	44 mm
Traversing path	10 m
Traversing rate	3 m/s
Cable weight	26 kg/km
Outer sheath, material	PUR
Material conductor insulation	PP
Conductor material	Bare Cu litz wires
Standards/specifications	M12 connector IEC 61076-2-101
Insulation resistance	≥ 100 GΩ*km

## Sensor/actuator cable - SAC-3P-MR/ 0,6-PUR/FS SCO - 1518779

### Technical data

#### Cable

Conductor resistance	≤ 58 Ω/m
Nominal voltage, cable	300 V
Test voltage, cable	3000 V
Ambient temperature (operation)	-40 °C ... 80 °C (cable, fixed installation)
	-5 °C ... 80 °C (cable, flexible installation)

#### Standards and Regulations

Standards/specifications	M12 connector IEC 61076-2-101
Flammability rating according to UL 94	HB

#### Environmental Product Compliance

China RoHS	Environmentally friendly use period: unlimited = EFUP-e
	No hazardous substances above threshold values

### Drawings

# Sensor/actuator cable - SAC-3P-MR/ 0,6-PUR/FS SCO - 1518779

Dimensional drawing

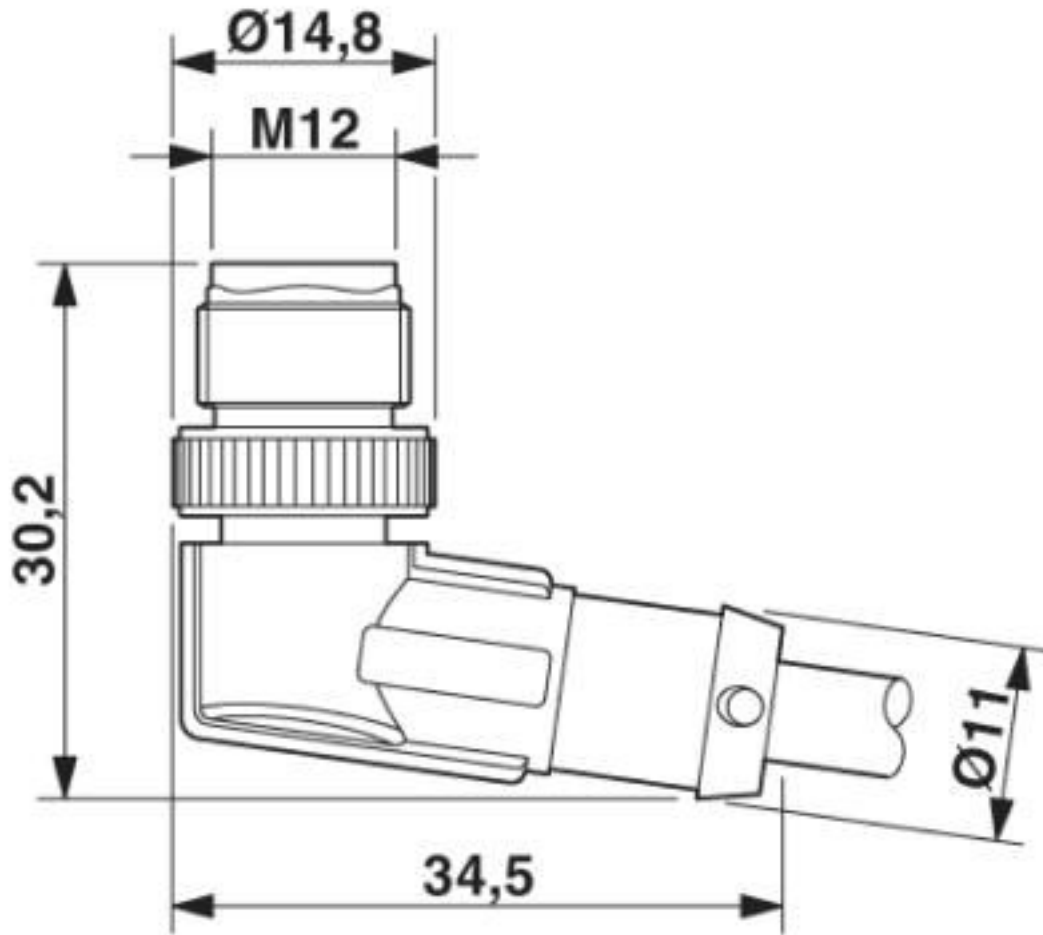

M12 x 1 male plug, angled

Dimensional drawing

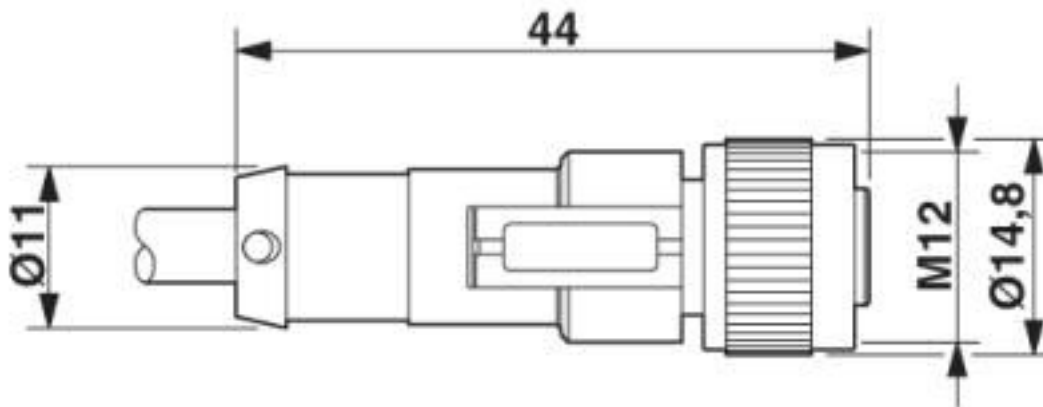

M12 x 1 socket, straight

# Sensor/actuator cable - SAC-3P-MR/ 0,6-PUR/FS SCO - 1518779

Circuit diagram

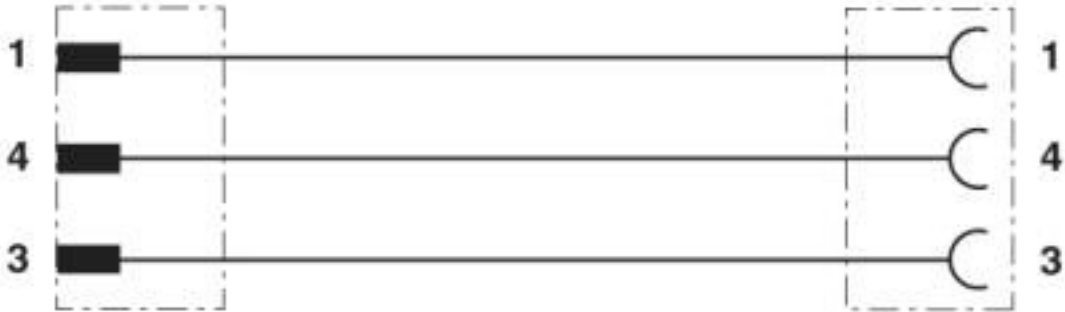

Contact assignment of the M12 plug and the M12 socket

Schematic diagram

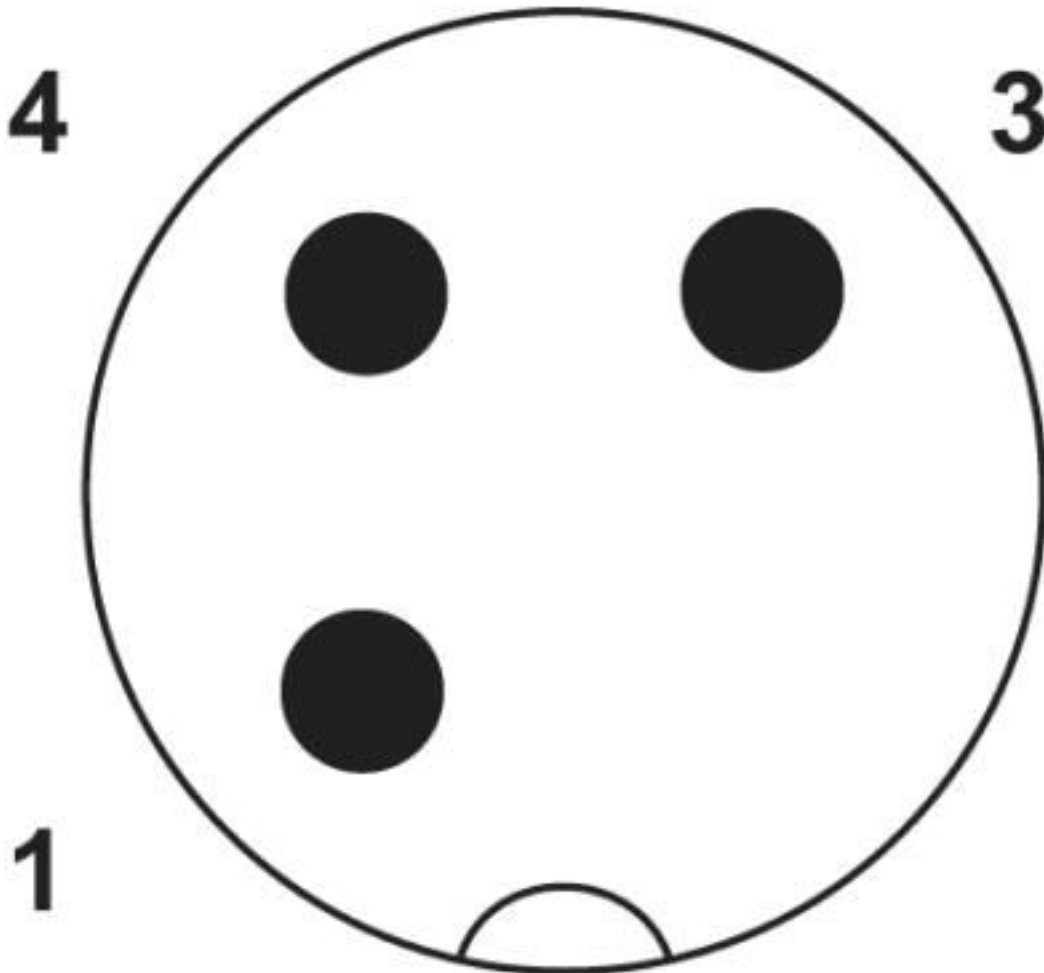

Pin assignment M12 plug, 3-pos., A-coded, view male side

# Sensor/actuator cable - SAC-3P-MR/ 0,6-PUR/FS SCO - 1518779

Schematic diagram

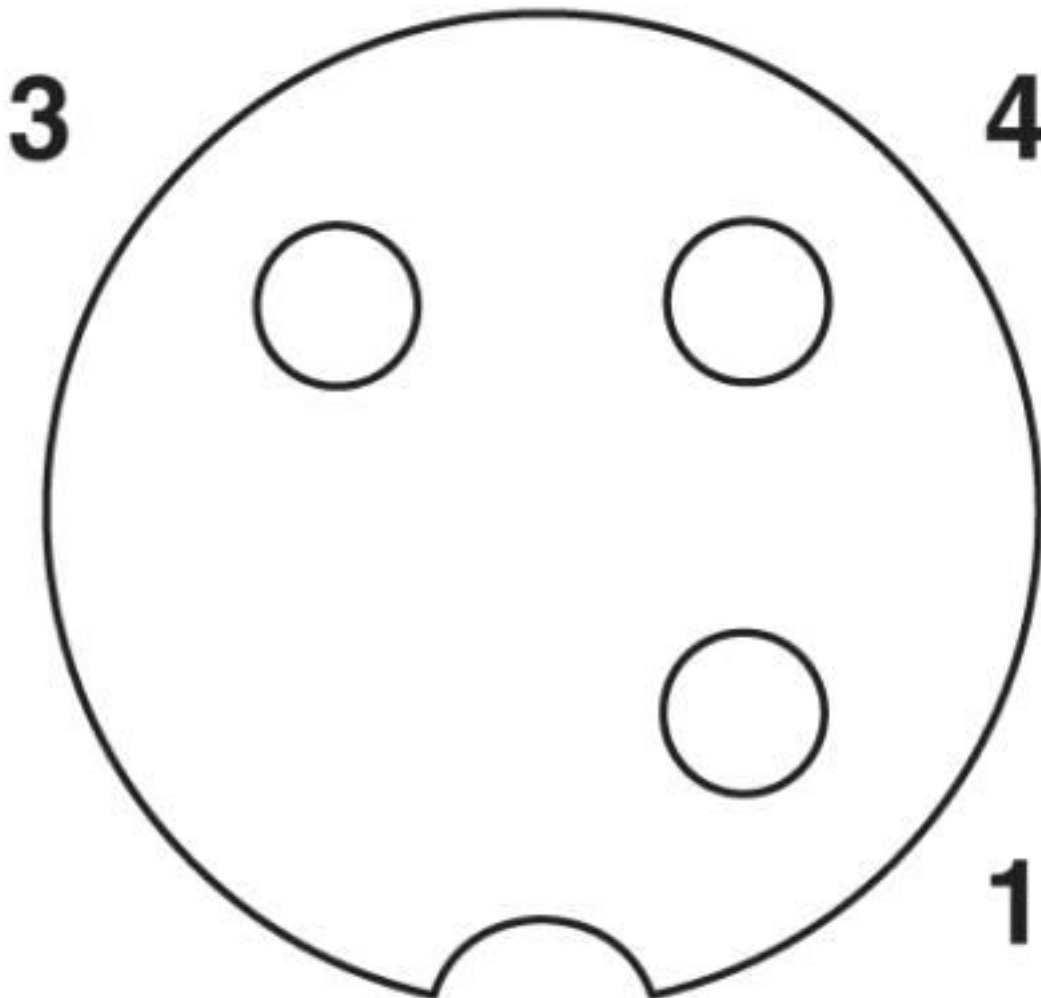

Pin assignment M12 socket, 3-pos., A-coded, view female side

## Classifications

eCl@ss

eCl@ss 4.0	27060306
eCl@ss 4.1	27060306
eCl@ss 5.0	27061801
eCl@ss 5.1	27061800
eCl@ss 6.0	27279200
eCl@ss 7.0	27279218
eCl@ss 8.0	27279218
eCl@ss 9.0	27060311

# Sensor/actuator cable - SAC-3P-MR/ 0,6-PUR/FS SCO - 1518779

## Classifications

### ETIM

ETIM 2.0	EC000830
ETIM 3.0	EC001855
ETIM 4.0	EC001855
ETIM 5.0	EC001855
ETIM 6.0	EC001855

### UNSPSC

UNSPSC 6.01	31251501
UNSPSC 7.0901	31251501
UNSPSC 11	31251501
UNSPSC 12.01	31251501
UNSPSC 13.2	31251501
UNSPSC 19.0	31251501

## Approvals

### Approvals

#### Approvals

UL Listed / cUL Listed / EAC / EAC / cULus Listed

#### Ex Approvals

### Approval details

UL Listed		<a href="http://database.ul.com/cgi-bin/XYV/template/LISEXT/1FRAME/index.htm">http://database.ul.com/cgi-bin/XYV/template/LISEXT/1FRAME/index.htm</a>	FILE E 221474
Nominal voltage UN	300 V		
Nominal current IN	4 A		

cUL Listed		<a href="http://database.ul.com/cgi-bin/XYV/template/LISEXT/1FRAME/index.htm">http://database.ul.com/cgi-bin/XYV/template/LISEXT/1FRAME/index.htm</a>	FILE E 221474
Nominal voltage UN	300 V		
Nominal current IN	4 A		

## Sensor/actuator cable - SAC-3P-MR/ 0,6-PUR/FS SCO - 1518779

### Approvals

EAC		EAC-Zulassung
-----	--	---------------

EAC		RU C- DE.BL08.B.00286
-----	--	--------------------------

cULus Listed		
--------------	--	--

### Accessories

#### Accessories

#### Conductor marking

Insert label - PABA WH/23 - 1013779



Insert label, Strip, white, unlabeled, can be labeled with: CMS-P1-PLOTTER, mounting type: thread on, cable diameter range: 1.5 ... 35 mm, lettering field size: 23 x 4 mm, Number of individual labels: 20

Insert label - PABA YE/23 - 1013782



Insert label, Strip, yellow, unlabeled, can be labeled with: CMS-P1-PLOTTER, mounting type: thread on, cable diameter range: 1.5 ... 35 mm, lettering field size: 23 x 4 mm, Number of individual labels: 20

#### Marker pen

Marker pen - B-STIFT - 1051993



Marker pen, for manual labeling of unprinted Zack strips, smear-proof and waterproof, line thickness 0.5 mm

#### Plug for cable screw gland



## Sensor/actuator cable - SAC-3P-MR/ 0,6-PUR/FS SCO - 1518779

### Accessories

Screw plug - PROT-M12 MS-PA-CHAIN - 1430899

M12 sealing cap with fixing band, for sensor cables, for free M12 sockets



---

### Protective cap

Sealing cap - PROT-M12 FS-PA-CHAIN - 1430873

M12 sealing cap made of plastic with fixing band, for sensor cables, for free M12 plugs



---

### Safety locking

Locking clip - SAC-M12-EXCLIP-M - 1558988



Locking clip for the pin side of sensor/actuator cables with M12 connector and M12 connectors for assembly, for knurl diameter: 15 mm or for Allen key with a wrench size of 14 mm, prevents the disconnection of plug-in connections without tools

Locking clip - SAC-M12-EXCLIP-F - 1558991



Locking clip for the socket side of sensor/actuator cables with M12 connector and M12 connectors for assembly, for knurl diameter: 15 mm or for Allen key with a wrench size of 14 mm, prevents the disconnection of plug-in connections without tools

---

### Screwdriver tools

Adapter insert - TSD-M SAC-BIT ADAPTER - 1212600



Adapter bit for TSD-M...torque tools, E6.3-1/4" drive with 4 mm hexagon to accommodate SAC bits

## Sensor/actuator cable - SAC-3P-MR/ 0,6-PUR/FS SCO - 1518779

### Accessories

Tool - SAC BIT M12-D15 - 1208432



Nut for assembling sensor/actuator cables with M12 connector and M12 connectors for assembly, with a knurl diameter of 15 mm, for 4 mm hexagonal drive

---

### Torque tool

Torque screwdriver - TSD 04 SAC - 1208429



Torque screwdriver, with preset torque of 0.4 Nm and 4 mm hexagonal drive for M12 connectors

---

Torque screwdriver - TSD-M 1,2NM - 1212224



Torque screw driver, accuracy as per EN ISO 6789 standard, adjustable from 0.3 - 1.2 Nm

---

---

Phoenix Contact 2020 © - all rights reserved  
<http://www.phoenixcontact.com>

PHOENIX CONTACT GmbH & Co. KG  
Flachsmarktstr. 8  
32825 Blomberg  
Germany  
Tel. +49 5235 300  
Fax +49 5235 3 41200  
<http://www.phoenixcontact.com>

## X-ON Electronics

Largest Supplier of Electrical and Electronic Components

*Click to view similar products for [Sensor Cables / Actuator Cables](#) category:*

*Click to view products by [Phoenix Contact](#) manufacturer:*

Other Similar products are found below :

[1300070444](#) [43-10984](#) [M83513/19-F01CP](#) [704000D02F120](#) [MDM25PH003BF222](#) [802027107404-1](#) [885030A09M010](#) [885030A09M020](#)  
[1200650174](#) [1200651332](#) [1200651713](#) [1200660171](#) [1200660208](#) [1200660343](#) [1200660804](#) [1200660845](#) [1200660926](#) [1200660977](#)  
[1200661173](#) [1200661354](#) [120066-1712](#) [1200720053](#) [1200720099](#) [1200720153](#) [1200720172](#) [1200720217](#) [1200720226](#) [1200720251](#)  
[1200720285](#) [1200720296](#) [1200720404](#) [1200730148](#) [1200730378](#) [1200800231](#) [1200860112](#) [1200860121](#) [1200860125](#) [1200860337](#)  
[1200860365](#) [1200860420](#) [1200870046](#) [1200870123](#) [1200870248](#) [1200980102](#) [1200660181](#) [1200660183](#) [1200660827](#) [1200660849](#)  
[1200661170](#) [1200661295](#)