

## Sensor/actuator cable - SAC-5P-M12MS-M12FS SH/.../... - 1536120

Please be informed that the data shown in this PDF Document is generated from our Online Catalog. Please find the complete data in the user's documentation. Our General Terms of Use for Downloads are valid (<http://phoenixcontact.com/download>)



Sensor/actuator cable, 5-position, Variable cable type, shielded, Plug straight M12, coding: A, on Socket straight M12, coding: A, cable length: Free input (0.2 ... 40.0 m)

### Your advantages

- ✓ Easy and safe: 100% electrically tested plug-in components
- ✓ Flexible solutions - configurable materials with variable cable types and cable lengths
- ✓ Reliable signal transmission – 360° shielding in environments with electromagnetic interference



### Key Commercial Data

Packing unit	1 pc
Minimum order quantity	25 pc

### Configuration

Cable type	PUR halogen-free black [PUR]
Length [m]	15

### Technical data

#### Dimensions

Length of cable	Free input (0.2 ... 40.0 m)
-----------------	-----------------------------

#### Ambient conditions

Ambient temperature (operation)	-25 °C ... 90 °C (Plug / socket)
Degree of protection	IP65
	IP67

#### General

Rated current at 40°C	4 A
Rated voltage	48 V AC
	60 V DC
Number of positions	5
Insulation resistance	≥ 100 MΩ

# Sensor/actuator cable - SAC-5P-M12MS-M12FS SH/.../... - 1536120

## Technical data

### General

Coding	A - standard
Standards/regulations	M12 connector IEC 61076-2-101
Status display	No
Protective circuit/component	unwired
Overvoltage category	II
Degree of pollution	3
Insertion/withdrawal cycles	≥ 100
Torque	0.4 Nm (M12 connector)

### Material

Flammability rating according to UL 94	HB
Contact material	CuSn
Contact surface material	Ni/Au
Contact carrier material	TPU GF
Material of grip body	TPU, hardly inflammable, self-extinguishing
Material, knurls	Zinc die-cast, nickel-plated
Sealing material	NBR

### Line characteristics

Note	This item is a sensor/actuator cable with a freely selectable cable type. The technical data for all possible cable types is listed in the table below.
------	---

### Standards and Regulations

Standards/specifications	M12 connector IEC 61076-2-101
Flammability rating according to UL 94	HB

### PUR halogen-free black [PUR]

Cable type	PUR halogen-free black
Cable type (abbreviation)	PUR
Cable abbreviation	LiF9YC11Y
UL AWM style	20549 / 10493 (80°C/300 V)
Conductor cross section	5x 0.34 mm <sup>2</sup> (Signal line)
AWG signal line	22
Conductor structure signal line	42x 0.10 mm
Core diameter including insulation	1.27 mm ±0.02 mm (Signal line)
Thickness, insulation	≥ 0.21 mm
Wire colors	Brown, white, blue, black, gray
Overall twist	5 wires around filler to the core
Shielding	Tinned copper braided shield
Optical shield covering	80 %
External sheath, color	black-gray RAL 7021
Outer sheath thickness	approx. 0.5 mm
External cable diameter D	5.25 mm ±0.2 mm

# Sensor/actuator cable - SAC-5P-M12MS-M12FS SH/.../... - 1536120

## Technical data

### PUR halogen-free black [PUR]

Smallest bending radius, fixed installation	26 mm
Smallest bending radius, movable installation	52 mm (up to +60°C)
Number of bending cycles	10000000
Bending radius	52 mm
Traversing path	10 m
Traversing rate	3 m/s
Acceleration	10 m/s <sup>2</sup>
Cable weight	43 kg/km
Outer sheath, material	PUR
Material conductor insulation	PP
Conductor material	Bare Cu litz wires
Insulation resistance	70 GΩ*km (at 20 °C)
Conductor resistance	max. 57 Ω/km (at 20 °C)
Nominal voltage, cable	300 V (at 20 °C)
Test voltage Core/Core	3000 V (at 20 °C)
Special properties	Flexible cable conduit capable
	Silicone-free
	Free of substances which would hinder coating with paint or varnish
	Low adhesion surface
Flame resistance	in accordance with UL 758/1581 FT2
	DIN EN 60332-2-2 (20 s)
Halogen-free	in accordance with DIN VDE 0472 part 815
	in accordance with DIN EN 50267-2-1
Resistance to oil	in accordance with DIN EN 60811-2-1
Other resistance	Highly resistant to acids, alkaline solutions and solvents
	hydrolysis and microbe resistant
	Resistant to salt water
	partly UV-resistant in accordance with DIN EN ISO 4892-2-A
	abrasion-resistant
Ambient temperature (operation)	-40 °C ... 80 °C (cable, fixed installation)
	-25 °C ... 80 °C (cable, flexible installation)

### PUR halogen-free gray [280]

Cable type	PUR halogen-free gray
Cable type (abbreviation)	280
Cable abbreviation	LiF9YC11Y
UL AWM style	20549 / 10493 (80°C/300 V)
Conductor cross section	5x 0.34 mm <sup>2</sup> (Signal line)
AWG signal line	22
Conductor structure signal line	42x 0.10 mm
Core diameter including insulation	1.27 mm ±0.02 mm (Signal line)

## Sensor/actuator cable - SAC-5P-M12MS-M12FS SH/.../... - 1536120

### Technical data

#### PUR halogen-free gray [280]

Thickness, insulation	≥ 0.21 mm
Wire colors	Brown, white, blue, black, gray
Overall twist	5 wires around filler to the core
Shielding	Tinned copper braided shield
Optical shield covering	80 %
External sheath, color	gray RAL 7001
Outer sheath thickness	approx. 0.5 mm
External cable diameter D	5.25 mm ±0.2 mm
Smallest bending radius, fixed installation	26 mm
Smallest bending radius, movable installation	52 mm (up to +60°C)
Number of bending cycles	10000000
Bending radius	52 mm
Traversing path	10 m
Traversing rate	3 m/s
Acceleration	10 m/s <sup>2</sup>
Cable weight	43 kg/km
Outer sheath, material	PUR
Material conductor insulation	PP
Conductor material	Bare Cu litz wires
Insulation resistance	70 GΩ*km (at 20 °C)
Conductor resistance	max. 57 Ω/km (at 20 °C)
Nominal voltage, cable	300 V (at 20 °C)
Test voltage Core/Core	3000 V (at 20 °C)
Special properties	Flexible cable conduit capable
	Silicone-free
	Free of substances which would hinder coating with paint or varnish
	Low adhesion surface
Flame resistance	in accordance with UL 758/1581 FT2
	DIN EN 60332-2-2 (20 s)
Halogen-free	in accordance with DIN VDE 0472 part 815
	in accordance with DIN EN 50267-2-1
Resistance to oil	in accordance with DIN EN 60811-2-1
Other resistance	Highly resistant to acids, alkaline solutions and solvents
	hydrolysis and microbe resistant
	Resistant to salt water
	partly UV-resistant in accordance with DIN EN ISO 4892-2-A
	abrasion-resistant
Ambient temperature (operation)	-40 °C ... 80 °C (cable, fixed installation)
	-25 °C ... 80 °C (cable, flexible installation)

#### PVC black [PVC]

# Sensor/actuator cable - SAC-5P-M12MS-M12FS SH/.../... - 1536120

## Technical data

### PVC black [PVC]

Cable type	PVC black
Cable type (abbreviation)	PVC
Conductor cross section	5x 0.34 mm <sup>2</sup> (Signal line)
AWG signal line	22
Conductor structure signal line	42x 0.10 mm
Core diameter including insulation	1.35 mm ±0.02 mm
Thickness, insulation	≥ 0.23 mm (Core insulation)
	≥ 0.76 mm (Outer cable sheath)
Wire colors	Brown, white, blue, black, gray
Overall twist	5 wires around filler to the core
Shielding	Tinned copper braided shield
Optical shield covering	85 %
External sheath, color	black RAL 9005
External cable diameter D	5.9 mm ±0.2 mm
Cable weight	55 kg/km
Outer sheath, material	PVC
Material, filler	PVC
Material conductor insulation	PVC
Conductor material	Bare Cu litz wires
Insulation resistance	≥ 10 MΩ*km (at 20 °C)
Conductor resistance	≤ 58 Ω/km (at 20 °C)
Nominal voltage, cable	≤ 300 V
Test voltage, cable	≥ 3000 V
Flame resistance	As per UL-Style 2464
Ambient temperature (operation)	-25 °C ... 80 °C (cable, fixed installation)
	-5 °C ... 80 °C (cable, flexible installation)

### PVC gray [500]

Cable type	PVC gray
Cable type (abbreviation)	500
Cable abbreviation	LiYCY
Conductor cross section	0.34 mm <sup>2</sup>
AWG signal line	22
Conductor structure signal line	42x 0.10 mm
Core diameter including insulation	1.35 mm ±0.02 mm
Thickness, insulation	≥ 0.23 mm (Core insulation)
	≥ 0.76 mm (Outer cable sheath)
Wire colors	Brown, white, blue, black, gray
Overall twist	5 wires around filler to the core
Shielding	Tinned copper braided shield
Optical shield covering	85 %

## Sensor/actuator cable - SAC-5P-M12MS-M12FS SH/.../... - 1536120

### Technical data

PVC gray [500]

External sheath, color	gray RAL 7001
External cable diameter D	5.9 mm ±0.2 mm
Cable weight	55 kg/km
Outer sheath, material	PVC
Material, filler	PVC
Material conductor insulation	PVC
Conductor material	Bare Cu litz wires
Insulation resistance	≥ 1 GΩ*km (at 20 °C)
Conductor resistance	max. 58 Ω/km (at 20 °C)
Nominal voltage, cable	≤ 300 V
Test voltage, cable	≥ 3000 V
Flame resistance	As per UL-Style 2464
Ambient temperature (operation)	-25 °C ... 80 °C (cable, fixed installation)
	-5 °C ... 80 °C (cable, flexible installation)

### Environmental Product Compliance

China RoHS	Environmentally friendly use period: unlimited = EFUP-e
	No hazardous substances above threshold values

### Drawings

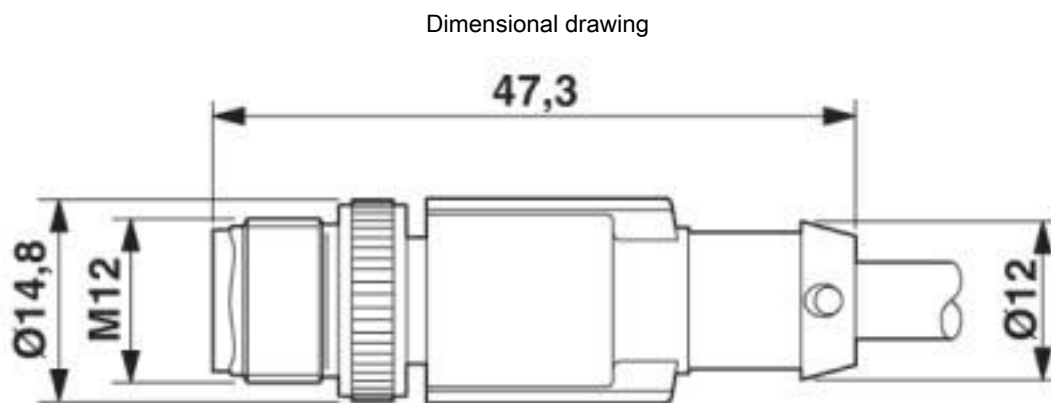

Plug, M12 x 1, straight, shielded

# Sensor/actuator cable - SAC-5P-M12MS-M12FS SH/.../... - 1536120

Dimensional drawing

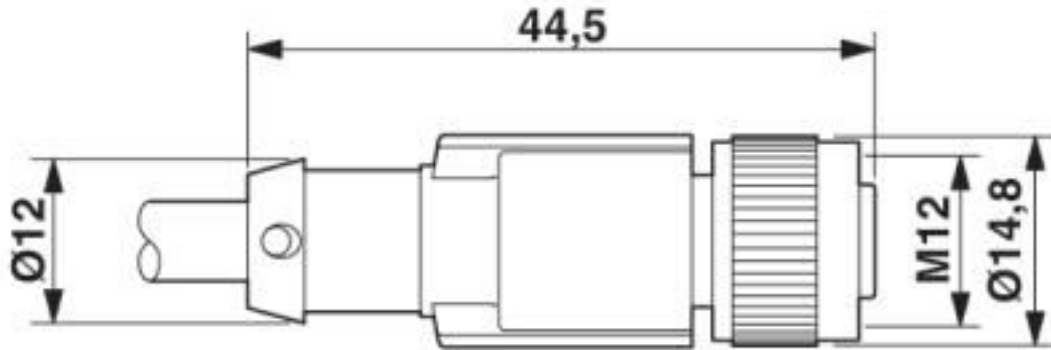

M12 x 1 socket, straight, shielded

Circuit diagram

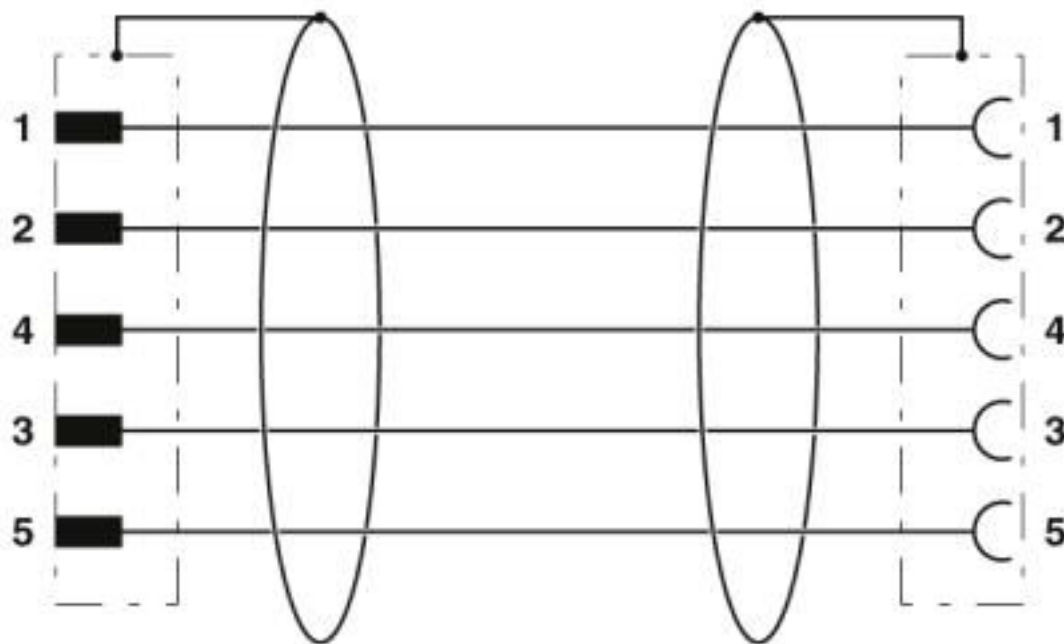

Contact assignment of the M12 plug and the M12 socket

# Sensor/actuator cable - SAC-5P-M12MS-M12FS SH/.../... - 1536120

Schematic diagram

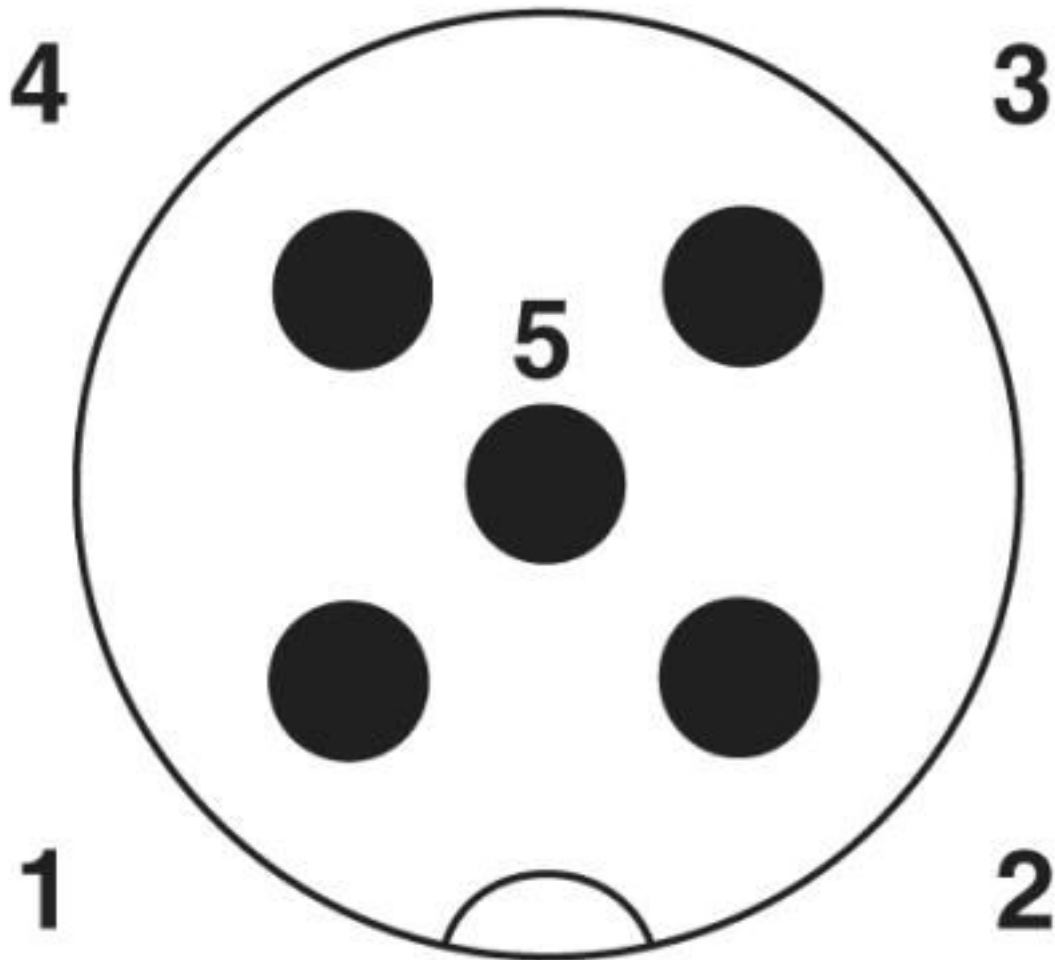

Pin assignment M12 male connector, 5-pos., A-coded, male side



# Sensor/actuator cable - SAC-5P-M12MS-M12FS SH/.../... - 1536120

Schematic diagram

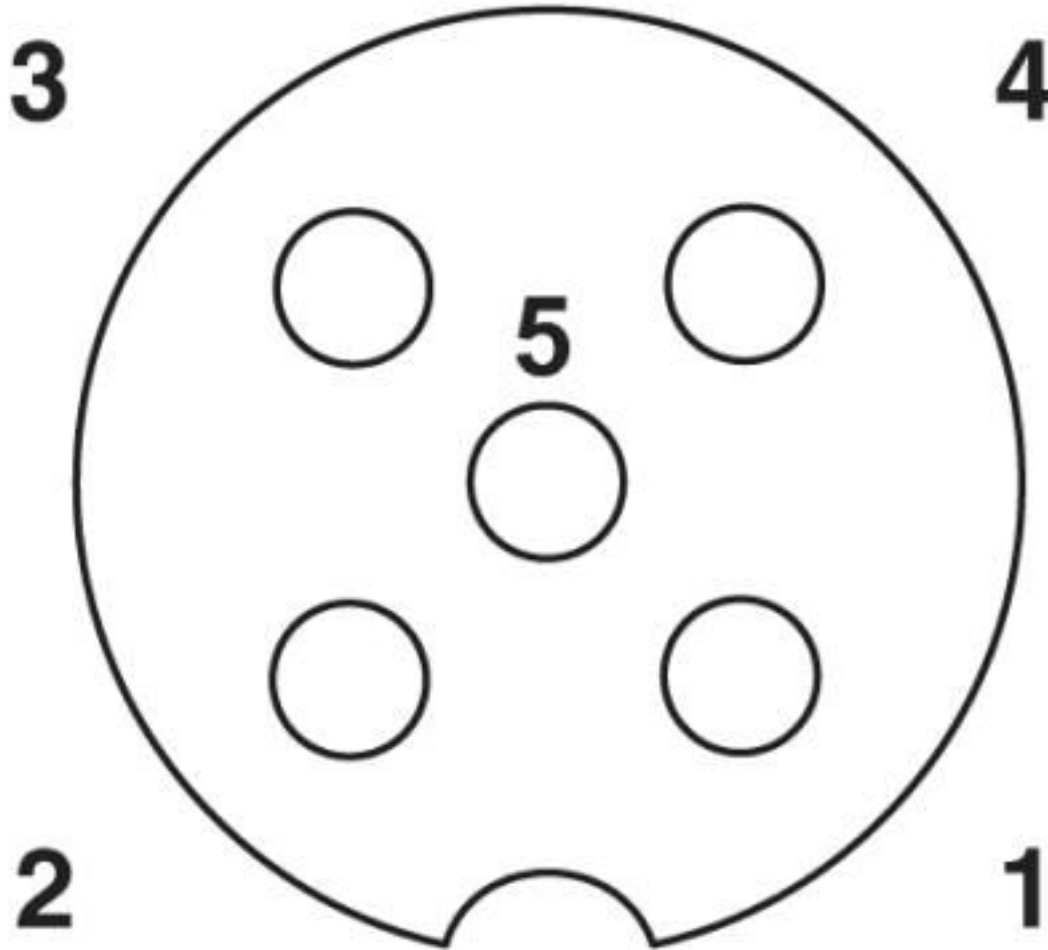

Pin assignment M12 socket, 5-pos., A-coded, socket side view

## Sensor/actuator cable - SAC-5P-M12MS-M12FS SH/.../... - 1536120

Cable cross section



PUR halogen-free black [PUR]

# Sensor/actuator cable - SAC-5P-M12MS-M12FS SH/.../... - 1536120

Cable cross section

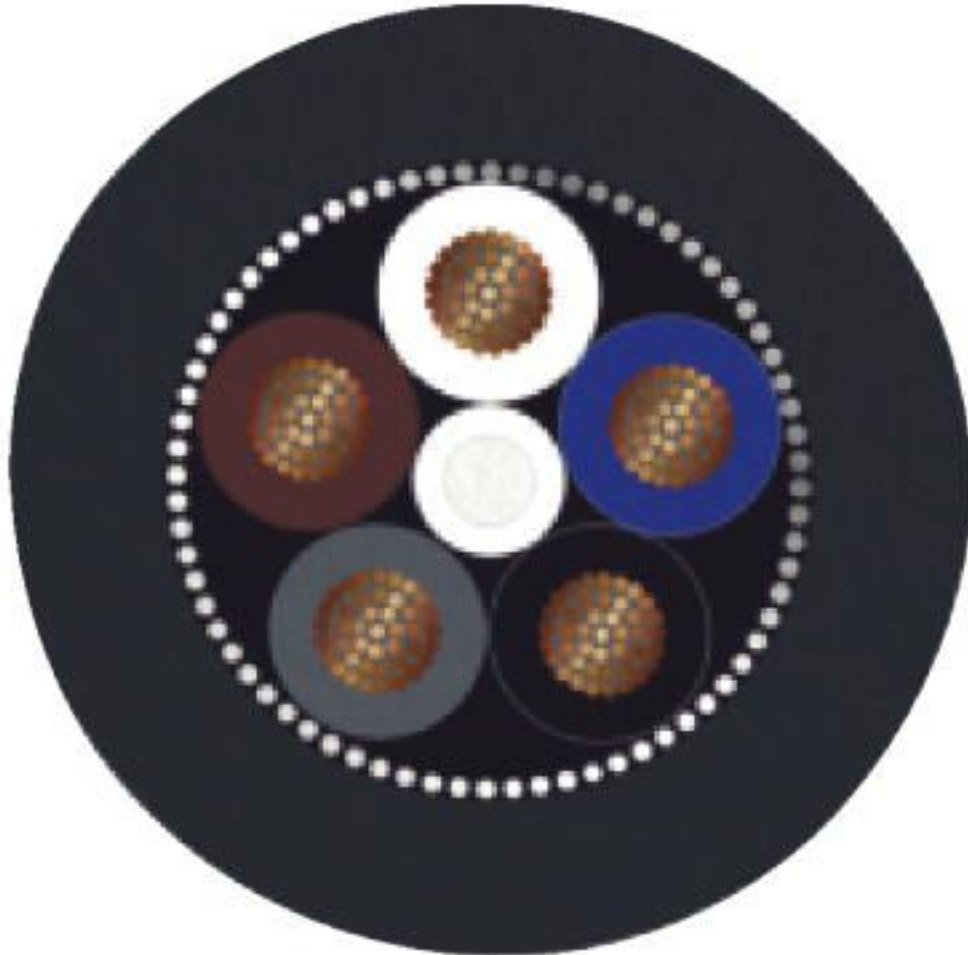

PVC black [PVC]

# Sensor/actuator cable - SAC-5P-M12MS-M12FS SH/.../... - 1536120

Cable cross section

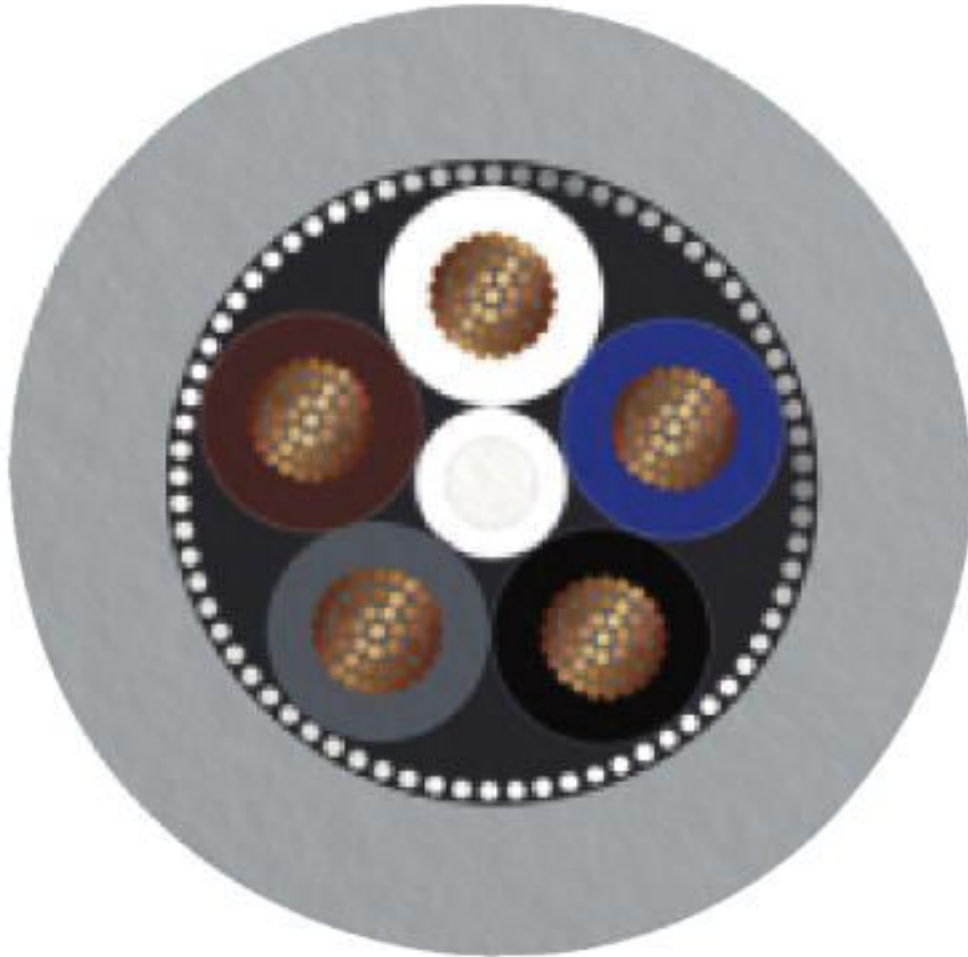

PVC gray [500]

## Classifications

eCl@ss

eCl@ss 10.0.1	27060311
eCl@ss 4.0	27060300
eCl@ss 4.1	27060300
eCl@ss 5.0	27061800
eCl@ss 5.1	27061800
eCl@ss 6.0	27279200
eCl@ss 7.0	27279218
eCl@ss 8.0	27279218
eCl@ss 9.0	27060311

# Sensor/actuator cable - SAC-5P-M12MS-M12FS SH/.../... - 1536120

## Classifications

### ETIM

ETIM 2.0	EC000830
ETIM 3.0	EC001855
ETIM 4.0	EC001855
ETIM 5.0	EC001855
ETIM 6.0	EC001855
ETIM 7.0	EC001855

### UNSPSC

UNSPSC 6.01	31251501
UNSPSC 7.0901	31251501
UNSPSC 11	31251501
UNSPSC 12.01	31251501
UNSPSC 13.2	31251501
UNSPSC 19.0	31251501
UNSPSC 20.0	31251501
UNSPSC 21.0	31251501

## Approvals

### Approvals

#### Approvals

UL Listed / cUL Listed / EAC-RoHS / EAC / cULus Listed

#### Ex Approvals

### Approval details

UL Listed		<a href="http://database.ul.com/cgi-bin/XYV/template/LISEXT/1FRAME/index.htm">http://database.ul.com/cgi-bin/XYV/template/LISEXT/1FRAME/index.htm</a>	FILE E 221474
Nominal voltage UN	125 V		
Nominal current IN	4 A		

cUL Listed		<a href="http://database.ul.com/cgi-bin/XYV/template/LISEXT/1FRAME/index.htm">http://database.ul.com/cgi-bin/XYV/template/LISEXT/1FRAME/index.htm</a>	FILE E 221474
Nominal voltage UN	125 V		

## Sensor/actuator cable - SAC-5P-M12MS-M12FS SH/.../... - 1536120

### Approvals

Nominal current I <sub>N</sub>	4 A
--------------------------------	-----

EAC-RoHS		RU D- DE.HB35.B.00387
----------	--	--------------------------

EAC		EAC-Zulassung
-----	--	---------------

cULus Listed		
--------------	--	--

### Accessories

#### Accessories

#### Conductor marking

Insert label - PABA WH/23 - 1013779



Insert label, Strip, white, unlabeled, can be labeled with: CMS-P1-PLOTTER, mounting type: thread on, cable diameter range: 1.5 ... 35 mm, lettering field size: 23 x 4 mm, Number of individual labels: 20

Insert label - PABA YE/23 - 1013782



Insert label, Strip, yellow, unlabeled, can be labeled with: CMS-P1-PLOTTER, mounting type: thread on, cable diameter range: 1.5 ... 35 mm, lettering field size: 23 x 4 mm, Number of individual labels: 20

#### Marker pen

Marker pen - B-STIFT - 1051993



Marker pen, for manual labeling of unprinted Zack strips, smear-proof and waterproof, line thickness 0.5 mm

## Sensor/actuator cable - SAC-5P-M12MS-M12FS SH/.../... - 1536120

### Accessories

#### Plug for cable screw gland

Screw plug - PROT-M12 MS-PA-CHAIN - 1430899

M12 sealing cap with fixing band, for sensor cables, for free M12 sockets



---

#### Protective cap

Sealing cap - PROT-M12 FS-PA-CHAIN - 1430873

M12 sealing cap made of plastic with fixing band, for sensor cables, for free M12 plugs



---

#### Safety locking

Locking clip - SAC-M12-EXCLIP-M - 1558988



Locking clip for the pin side of sensor/actuator cables with M12 connector and M12 connectors for assembly, for knurl diameter: 15 mm or for Allen key with a wrench size of 14 mm, prevents the disconnection of plug-in connections without tools

Locking clip - SAC-M12-EXCLIP-F - 1558991



Locking clip for the socket side of sensor/actuator cables with M12 connector and M12 connectors for assembly, for knurl diameter: 15 mm or for Allen key with a wrench size of 14 mm, prevents the disconnection of plug-in connections without tools

---

#### Screwdriver tools

Adapter insert - TSD-M SAC-BIT ADAPTER - 1212600



Adapter bit for TSD-M...torque tools, E6.3-1/4" drive with 4 mm hexagon to accommodate SAC bits

## Sensor/actuator cable - SAC-5P-M12MS-M12FS SH/.../... - 1536120

### Accessories

Tool - SAC BIT M12-D15 - 1208432



Nut for assembling sensor/actuator cables with M12 connector and M12 connectors for assembly, with a knurl diameter of 15 mm, for 4 mm hexagonal drive

---

### Torque tool

Torque screwdriver - TSD 04 SAC - 1208429



Torque screwdriver, with preset torque of 0.4 Nm and 4 mm hexagonal drive for M12 connectors

---

Torque screwdriver - TSD-M 1,2NM - 1212224



Torque screw driver, accuracy as per EN ISO 6789 standard, adjustable from 0.3 - 1.2 Nm

---

Phoenix Contact 2020 © - all rights reserved  
<http://www.phoenixcontact.com>

PHOENIX CONTACT GmbH & Co. KG  
Flachsmarktstr. 8  
32825 Blomberg  
Germany  
Tel. +49 5235 300  
Fax +49 5235 3 41200  
<http://www.phoenixcontact.com>



## X-ON Electronics

Largest Supplier of Electrical and Electronic Components

*Click to view similar products for [Sensor Cables / Actuator Cables](#) category:*

*Click to view products by [Phoenix Contact](#) manufacturer:*

Other Similar products are found below :

[60963](#) [60964](#) [703000D02F2002](#) [703001D02F0602](#) [703001D02F300](#) [704000D02F120](#) [773032K02F030](#) [802027107404-1](#) [802027213811-1](#)  
[804001A09M150](#) [805001A09M0502](#) [84914-0235](#) [84914-0237](#) [885030A09M020](#) [8R4J30E03C3003](#) [1200651332](#) [1200651713](#) [1200660844](#)  
[1200660845](#) [1200661173](#) [1200680071](#) [1200720053](#) [1200720081](#) [1200720099](#) [1200720217](#) [1200800231](#) [1200860125](#) [1200870123](#)  
[1200980102](#) [1200650267](#) [1200650298](#) [1200660183](#) [1200660782](#) [1200660849](#) [1200661295](#) [1200661297](#) [1200661342](#) [1200661343](#)  
[1200670080](#) [1200670220](#) [1200680331](#) [1200720252](#) [1200730184](#) [1200860344](#) [1200870359](#) [1200870643](#) [1200980008](#) [1200980031](#)  
[1210502211](#) [1210400542](#)