

Bus system flat-type plug - SACCBP-M12FS-8CON-M16/2,0-940 - 1553381

Please be informed that the data shown in this PDF Document is generated from our Online Catalog. Please find the complete data in the user's documentation. Our General Terms of Use for Downloads are valid (<http://phoenixcontact.com/download>)



Bus system flush-type socket, Ethernet, 8-pos., M12, shielded, rear/screw mounting with M16 thread, with 2 m bus cable, 4 x 2 x 0.14 mm²



Ethernet

Key Commercial Data

Packing unit	1 pc
GTIN	
GTIN	4046356162364

Technical data

Dimensions

Length of cable	2 m
-----------------	-----

Ambient conditions

Ambient temperature (operation)	-25 °C ... 90 °C (Plug / socket)
Degree of protection	IP67 (When plugged in)
	IP65 (When plugged in)

General

Rated current at 40°C	2 A
Rated voltage	30 V
Number of positions	8
Insulation resistance	≥ 100 MΩ
Coding	A - standard
Status display	No
Overvoltage category	II
Degree of pollution	3

Material

Bus system flat-type plug - SACCBP-M12FS-8CON-M16/2,0-940 - 1553381

Technical data

Material

Flammability rating according to UL 94	V0
Contact material	CuZn
Contact surface material	Ni/Au
Contact carrier material	PA 6.6
Material, knurls	Nickel-plated brass
Sealing material	NBR

Standards and Regulations

Flammability rating according to UL 94	V0
--	----

Cable

Cable type	Ethernet flexible CAT5, 4-pair
Cable type (abbreviation)	94B
UL AWM style	20963 (80°C/30 V)
Signal type/category	Ethernet CAT5 (IEC 11801), 1 Gbps
Cable structure	4x2xAWG26/7; SF/UTP
Conductor cross section	4x 2x 0.14 mm ²
AWG signal line	26
Conductor structure signal line	7x 0.16 mm
Core diameter including insulation	0.96 mm
Wire colors	white/blue-blue, white/orange-orange, white/green-green, white/brown-brown
Twisted pairs	2 cores to the pair
Overall twist	4 pairs for core
Shielding	Aluminum-coated foil, tinned copper braided shield
Optical shield covering	70 %
External sheath, color	water blue RAL 5021
Outer sheath thickness	1.05 mm
External cable diameter D	6.4 mm ±0.2 mm
Minimum bending radius, fixed installation	4 x D
Minimum bending radius, flexible installation	8 x D
Tensile strength GRP	≤ 100 N
Cable weight	47 kg/km
Outer sheath, material	PUR
Material conductor insulation	Foamed PE
Conductor material	Bare Cu litz wires
Insulation resistance	≥ 500 MΩ*km
Loop resistance	≤ 290.00 Ω/km
Cable capacity	48 nF/km (at 1 kHz)
Wave impedance	100 Ω ±5 Ω (at 100 MHz)
Near end crosstalk attenuation (NEXT)	71.3 dB (with 1 MHz)

Bus system flat-type plug - SACCBP-M12FS-8CON-M16/2,0-940 - 1553381

Technical data

Cable

	62.3 dB (at 4 MHz)
	56.3 dB (at 10 MHz)
	53.2 dB (at 16 MHz)
	51.8 dB (at 20 MHz)
	48.9 dB (at 31.25 MHz)
	44.4 dB (at 62.5 MHz)
	41.3 dB (at 100 MHz)
Power-summated near end crosstalk attenuation (PSNEXT)	62.3 dB (with 1 MHz)
	53.3 dB (at 4 MHz)
	47.3 dB (at 10 MHz)
	44.2 dB (at 16 MHz)
	42.8 dB (at 20 MHz)
	39.9 dB (at 31.25 MHz)
	35.4 dB (at 62.5 MHz)
	32.3 dB (at 100 MHz)
Attenuation	3.2 dB (with 1 MHz)
	6 dB (at 4 MHz)
	9.5 dB (at 10 MHz)
	12.1 dB (at 16 MHz)
	13.6 dB (at 20 MHz)
	17.1 dB (at 31.25 MHz)
	24.8 dB (at 62.5 MHz)
	32 dB (at 100 MHz)
Return loss (RL)	23 dB (at 4 MHz)
	24.1 dB (at 8 MHz)
	25 dB (at 10 MHz)
	25 dB (at 16 MHz)
	25 dB (at 20 MHz)
	23.6 dB (at 31.25 MHz)
	21.5 dB (at 62.5 MHz)
	20.1 dB (at 100 MHz)
Signal runtime	5.3 ns/m
Coupling resistance	≤ 100.00 mΩ/m (at 10 MHz)
Nominal voltage, cable	≤ 100 V
Test voltage Core/Core	700 V (50 Hz, 1 min.)
Test voltage Core/Shield	700 V (50 Hz, 1 min.)
Flame resistance	according to IEC 60332-1-2
Halogen-free	according to IEC 60754-1
Resistance to oil	according to EN 60811-2-1

Bus system flat-type plug - SACCBP-M12FS-8CON-M16/2,0-940 - 1553381

Technical data

Cable

Ambient temperature (operation)	-40 °C ... 80 °C (cable, fixed installation)
	-20 °C ... 80 °C (cable, flexible installation)
Ambient temperature (installation)	-20 °C ... 80 °C
Ambient temperature (storage/transport)	-20 °C ... 80 °C

Environmental Product Compliance

REACH SVHC	Lead 7439-92-1
China RoHS	Environmentally Friendly Use Period = 50 years
	For details about hazardous substances go to tab "Downloads", Category "Manufacturer's declaration"

Drawings

Bus system flat-type plug - SACCBP-M12FS-8CON-M16/2,0-940 - 1553381

Schematic diagram

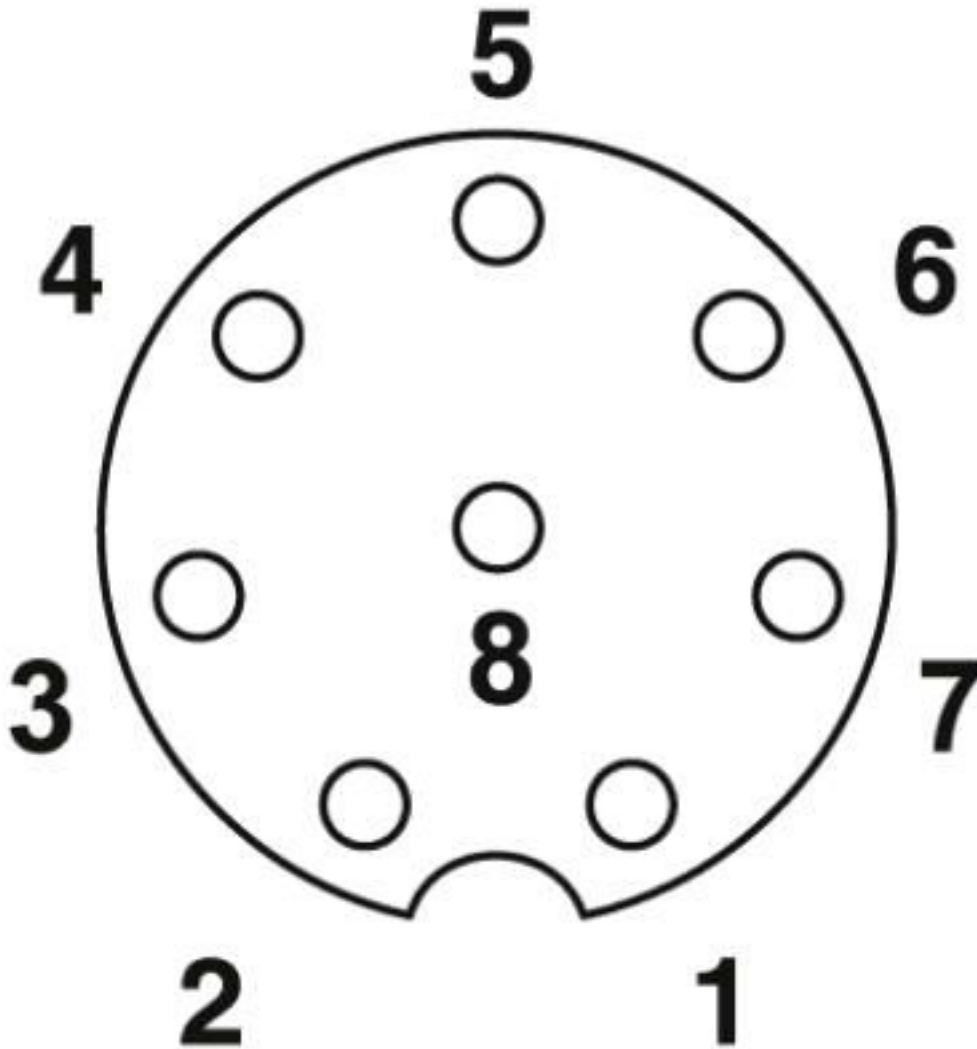

Pin assignment M12 socket, 8-pos., A-coded, view female side

Bus system flat-type plug - SACCBP-M12FS-8CON-M16/2,0-940 - 1553381

Dimensional drawing

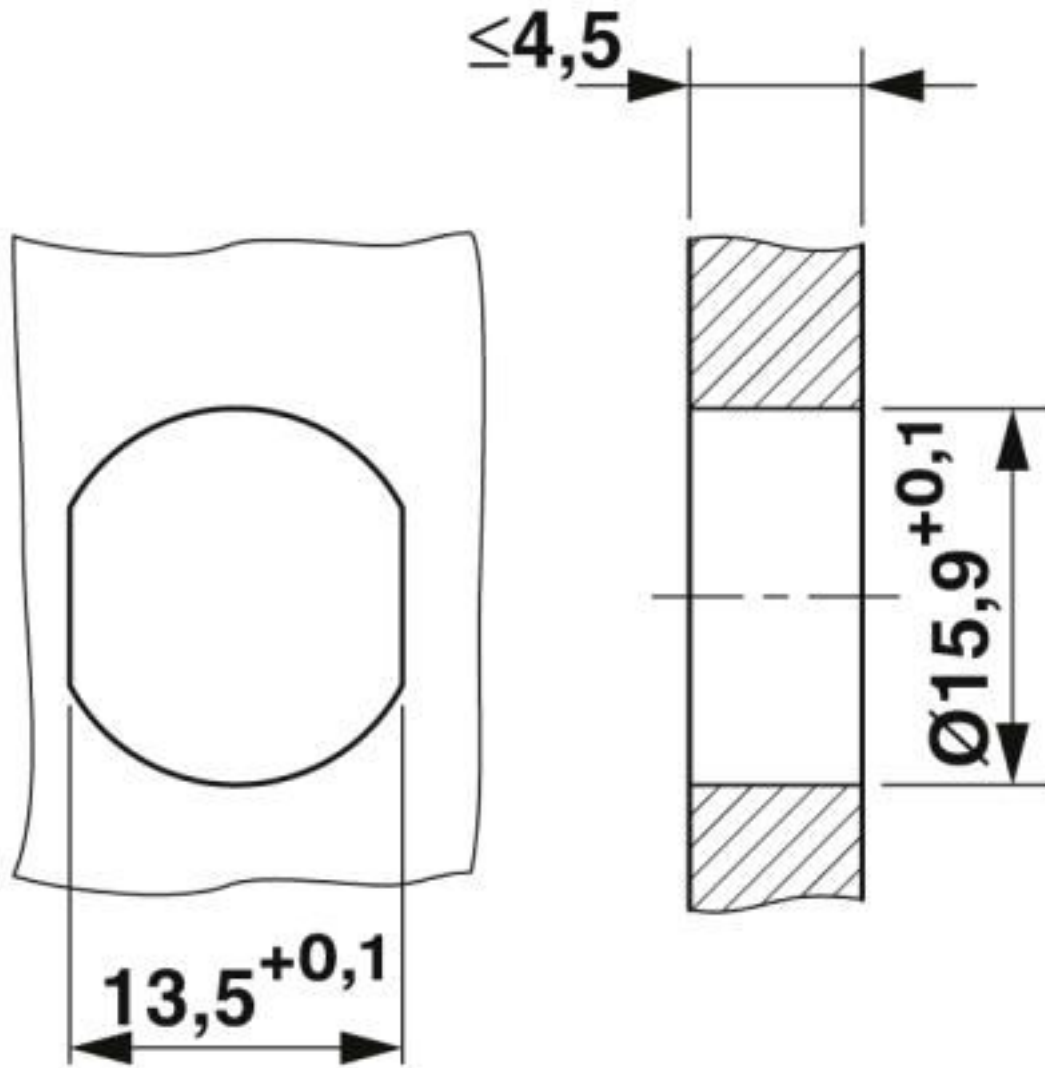

Housing cutout for M16 fastening thread, mounting panel with feed-through hole (alternatively with surface as protection against rotation)

Bus system flat-type plug - SACCBP-M12FS-8CON-M16/2,0-940 - 1553381

Dimensional drawing

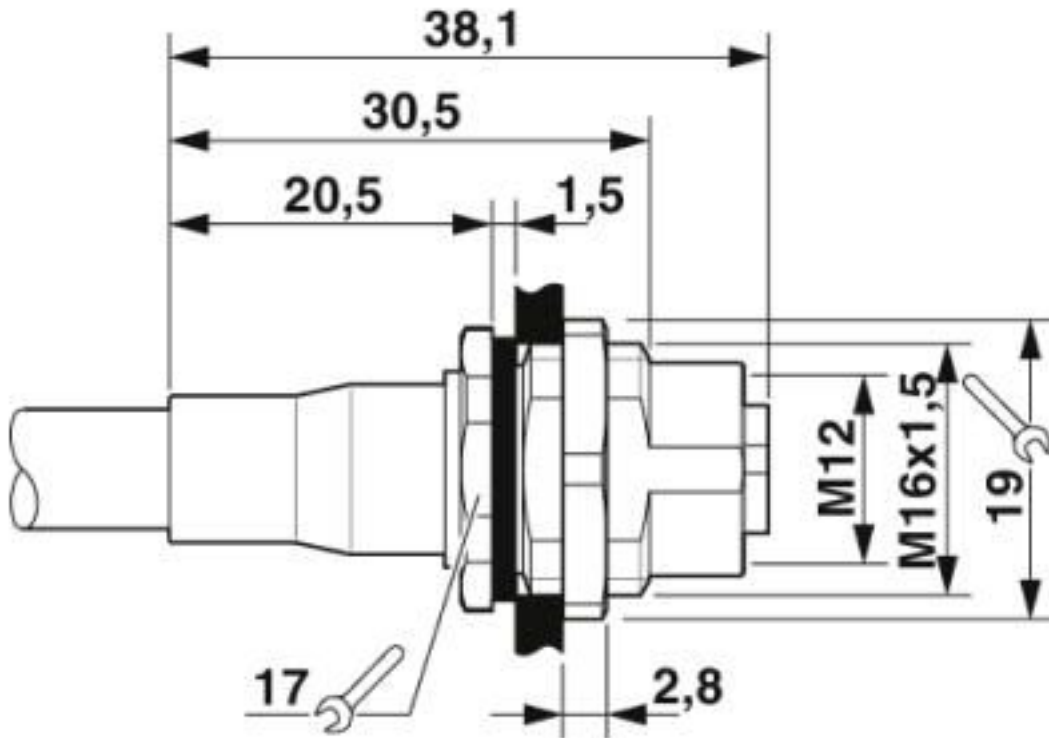

M12 flush-type connector

Bus system flat-type plug - SACCBP-M12FS-8CON-M16/2,0-940 - 1553381

Circuit diagram

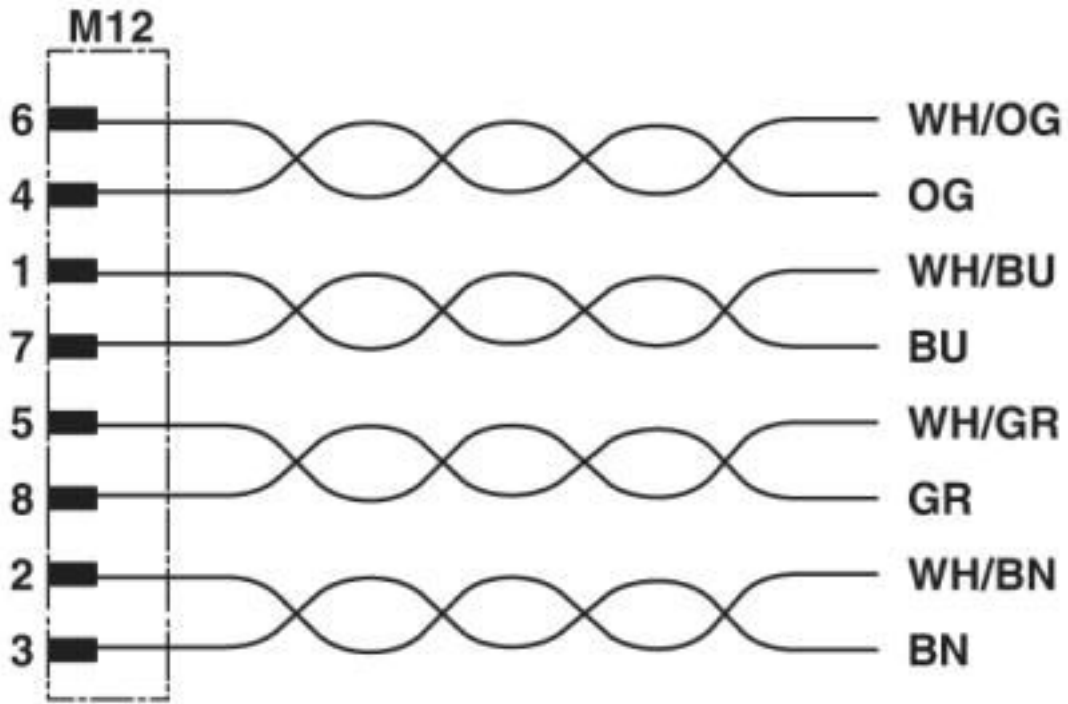

Contact assignment of the M12 plug and the M12 socket

Bus system flat-type plug - SACCBP-M12FS-8CON-M16/2,0-940 - 1553381

Cable cross section



Ethernet flexible CAT5, 4-pair [94B]

Classifications

eCl@ss

eCl@ss 10.0.1	27440102
eCl@ss 4.0	27140800
eCl@ss 4.1	27140800
eCl@ss 5.0	27143400
eCl@ss 5.1	27143400
eCl@ss 6.0	27279200
eCl@ss 7.0	27440103
eCl@ss 8.0	27440103
eCl@ss 9.0	27440102

Bus system flat-type plug - SACCBP-M12FS-8CON-M16/2,0-940 - 1553381

Classifications

ETIM

ETIM 3.0	EC002061
ETIM 4.0	EC000830
ETIM 5.0	EC002061
ETIM 6.0	EC002061

UNSPSC

UNSPSC 6.01	31251501
UNSPSC 7.0901	31251501
UNSPSC 11	31251501
UNSPSC 12.01	31251501
UNSPSC 13.2	39121413
UNSPSC 18.0	39121413
UNSPSC 19.0	39121413
UNSPSC 20.0	39121413
UNSPSC 21.0	39121413

Approvals

Approvals

Approvals

UL Recognized / EAC

Ex Approvals

Approval details

UL Recognized		http://database.ul.com/cgi-bin/XYV/template/LISEXT/1FRAME/index.htm	FILE E 118976
Nominal voltage UN	30 V		
Nominal current IN	2 A		
mm²/AWG/kcmil	24		

EAC		B.01687
-----	---	---------

Phoenix Contact 2020 © - all rights reserved
<http://www.phoenixcontact.com>

PHOENIX CONTACT GmbH & Co. KG
Flachsmarktstr. 8
32825 Blomberg
Germany
Tel. +49 5235 300
Fax +49 5235 3 41200
<http://www.phoenixcontact.com>

X-ON Electronics

Largest Supplier of Electrical and Electronic Components

Click to view similar products for [Ethernet Cables / Networking Cables](#) category:

Click to view products by [Phoenix Contact](#) manufacturer:

Other Similar products are found below :

[73-6670-7](#) [73-6680-15](#) [73-7797-25](#) [MCJB2-10P6Q7-120](#) [84909-0204](#) [1200700174](#) [1200860368](#) [E16A06002M030](#) [E200102-009-S1](#)
[AX105346-EW](#) [MT14-187L](#) [17-103530](#) [ERWPAB3002M005](#) [190-038045-01](#) [NK5EPC18RDY](#) [NK5EPC18VLY](#) [NK5EPC18YLY](#)
[NK5EPC1GRY](#) [NK5EPC4Y](#) [NK5EPC6YLY](#) [NK5EPC8BLY](#) [NK5EPC9YLY](#) [1969343-6](#) [C501100010](#) [C501106002](#) [C501106007](#)
[C501106015](#) [C501106025](#) [C601102010](#) [C601104010](#) [C601106007](#) [C601106015](#) [2142758-2](#) [2168427-2](#) [CAT1106007](#) [21949-1](#) [2J1866A](#)
[RJF SFTP 5E 0500](#) [AX100351](#) [MN14CEC/ST](#) [C501100015](#) [C501106004](#) [C501106010](#) [C5F1108007](#) [C601104004](#) [C601106004](#)
[CA21106004](#) [CA21106010](#) [CA21106015](#) [CA21109007](#)