

Sensor/actuator cable - SAC-4P-M12MS/1,5-800/M12FR-3L - 1567199

Please be informed that the data shown in this PDF Document is generated from our Online Catalog. Please find the complete data in the user's documentation. Our General Terms of Use for Downloads are valid (<http://phoenixcontact.com/download>)



Sensor/actuator cable, 4-position, PUR halogen-free, resistant to welding sparks, highly flexible, gray RAL 7001, Plug straight M12, coding: A, on Socket angled M12, coding: A, with 3 LEDs, cable length: 1.5 m, for robots and drag chains

Your advantages

- ✓ Easy and safe: 100% electrically tested plug-in components
- ✓ Flexible: cable supports a high degree of torsion and bending
- ✓ Reliable solution for the body shop as cable is resistant to welding sparks
- ✓ Convenient: increased machine availability thanks to quick and easy diagnostics

Key Commercial Data

Packing unit	1 pc
GTIN	 4 046356 326988
GTIN	4046356326988

Technical data

Dimensions

Length of cable	1.5 m
-----------------	-------

Ambient conditions

Ambient temperature (operation)	-25 °C ... 90 °C (Plug / socket)
Degree of protection	IP65
	IP67
	IP68

General

Rated current at 40 °C	4 A
Rated voltage	24 V DC
Number of positions	4
Insulation resistance	≥ 100 MΩ

Sensor/actuator cable - SAC-4P-M12MS/1,5-800/M12FR-3L - 1567199

Technical data

General

Coding	A - standard
Standards/regulations	M12 connector IEC 61076-2-101
Status display	3 LEDs
Protective circuit/component	unwired
Overvoltage category	II
Degree of pollution	3
Insertion/withdrawal cycles	≥ 100
Torque	0.4 Nm (M12 connector)

Material

Flammability rating according to UL 94	HB
Contact material	CuSn
Contact surface material	Ni/Au
Contact carrier material	TPU GF
Material of grip body	TPU, hardly inflammable, self-extinguishing
Material, knurls	Zinc die-cast, nickel-plated
Sealing material	NBR

Standards and Regulations

Standards/specifications	M12 connector IEC 61076-2-101
Flammability rating according to UL 94	HB

Cable

Note	Due to the extremely robust outer sheath, this cable should only be stripped in 5 cm increments.
Cable type	Gray, highly flexible PUR
Cable type (abbreviation)	800
Cable abbreviation	LiF9Y11Y
UL AWM style	20549
Conductor cross section	4x 0.34 mm ² (Signal line)
AWG signal line	22
Conductor structure signal line	42x 0.10 mm
Core diameter including insulation	1.3 mm ±0.05 mm (Signal line)
Wire colors	brown, white, blue, black
Overall twist	4 wires, twisted
External sheath, color	gray RAL 7001
External cable diameter D	4.8 mm ±0.2 mm
Minimum bending radius, fixed installation	4 x D
Minimum bending radius, flexible installation	7.5 x D
Number of bending cycles	10000000
Minimum bending radius, drag chain applications	7,5 x D
Traversing path	5 m
Traversing rate	3.3 m/s

Sensor/actuator cable - SAC-4P-M12MS/1,5-800/M12FR-3L - 1567199

Technical data

Cable

Acceleration	5 m/s ²
Number of bending cycles	15000000
Bending radius	50 mm
Traversing path	0.9 m
Traversing rate	5 m/s
Acceleration	30 m/s ²
Torsion force	± 360 °/m (1 000 000 torsion cycles)
Cable weight	33.5 kg/km
Outer sheath, material	PUR
Material conductor insulation	PP
Conductor material	Bare Cu litz wires
Insulation resistance	≥ 20 MΩ*km
Conductor resistance	approx. 53 Ω/km
Nominal voltage, cable	300 V
Test voltage, cable	2000 V
Special properties	Cable jacket is welding spark-resistant, recyclable, matt, low-adhesion, abrasion-resistant, flame-retardant, and self-extinguishing
	Free from silicone and cadmium
	Free of substances which would hinder coating with paint or varnish
Flame resistance	in accordance with UL 758/1581 FT2
Halogen-free	in accordance with DIN VDE 0472 part 815
Resistance to oil	in accordance with DIN EN 60811-2-1
Other resistance	Highly resistant to acids, alkaline solutions and solvents
	Silicone-free
Ambient temperature (operation)	-40 °C ... 80 °C (cable, fixed installation)
	-25 °C ... 80 °C (cable, flexible installation)

Environmental Product Compliance

China RoHS	Environmentally friendly use period: unlimited = EFUP-e
	No hazardous substances above threshold values

Drawings

Sensor/actuator cable - SAC-4P-M12MS/1,5-800/M12FR-3L - 1567199

Dimensional drawing



Plug, M12 x 1, straight, shielded

Dimensional drawing

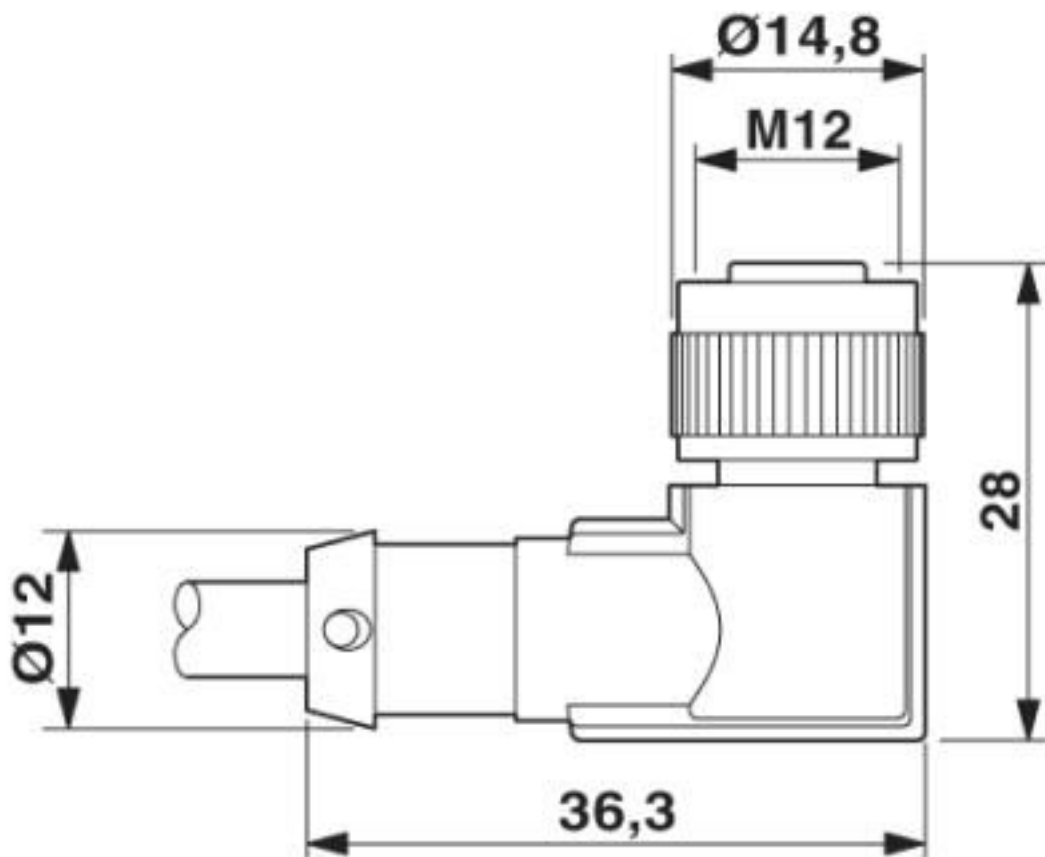

Socket M12 x 1, angled, with LED

Sensor/actuator cable - SAC-4P-M12MS/1,5-800/M12FR-3L - 1567199

Circuit diagram

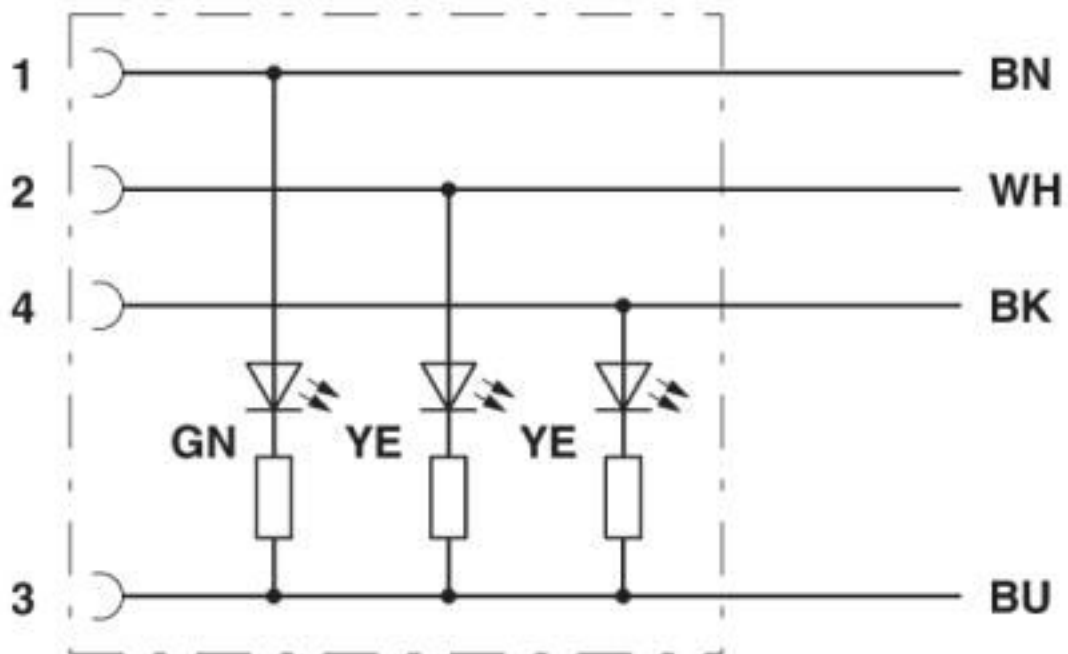

Contact assignment of the M12 plug and the M12 socket

Sensor/actuator cable - SAC-4P-M12MS/1,5-800/M12FR-3L - 1567199

Schematic diagram



Pin assignment M12 plug, 4-pos., A-coded, view plug side

Sensor/actuator cable - SAC-4P-M12MS/1,5-800/M12FR-3L - 1567199

Schematic diagram

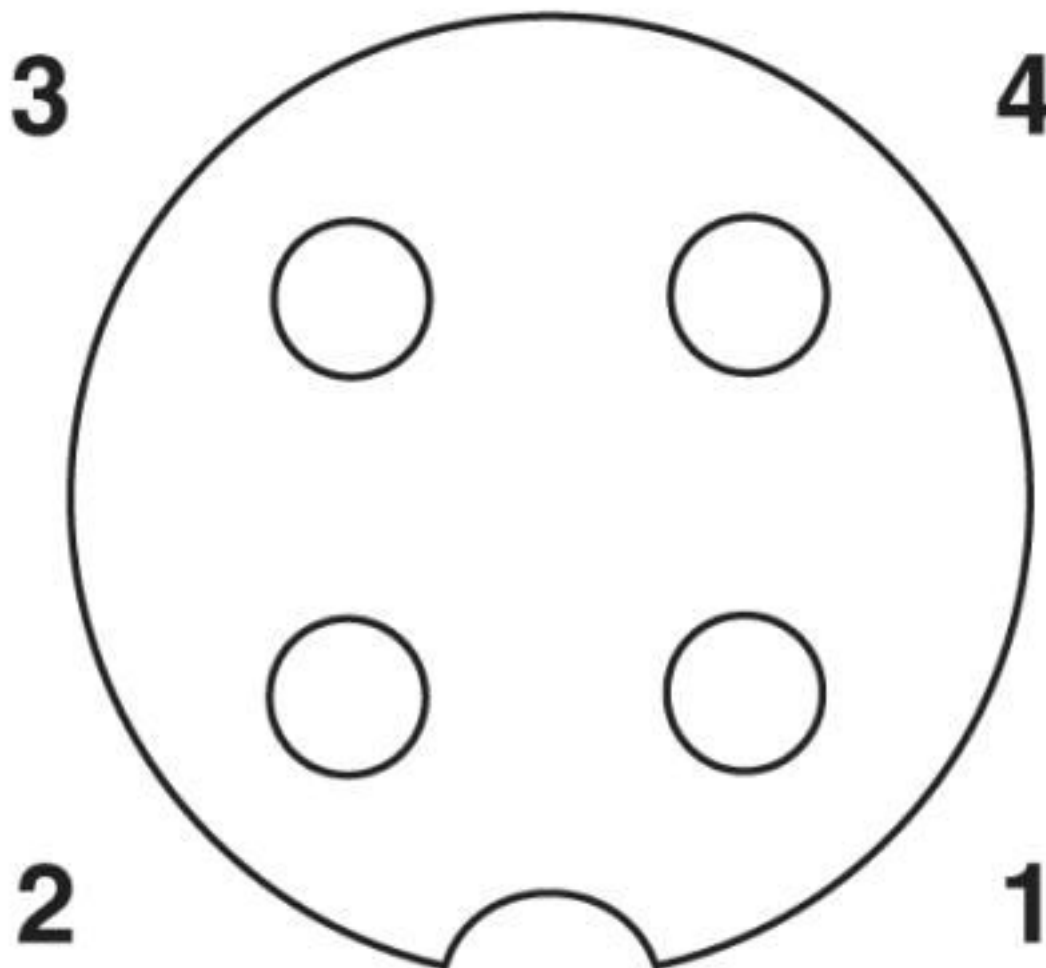

Pin assignment M12 socket, 4-pos., A-coded, view female side

Sensor/actuator cable - SAC-4P-M12MS/1,5-800/M12FR-3L - 1567199

Cable cross section

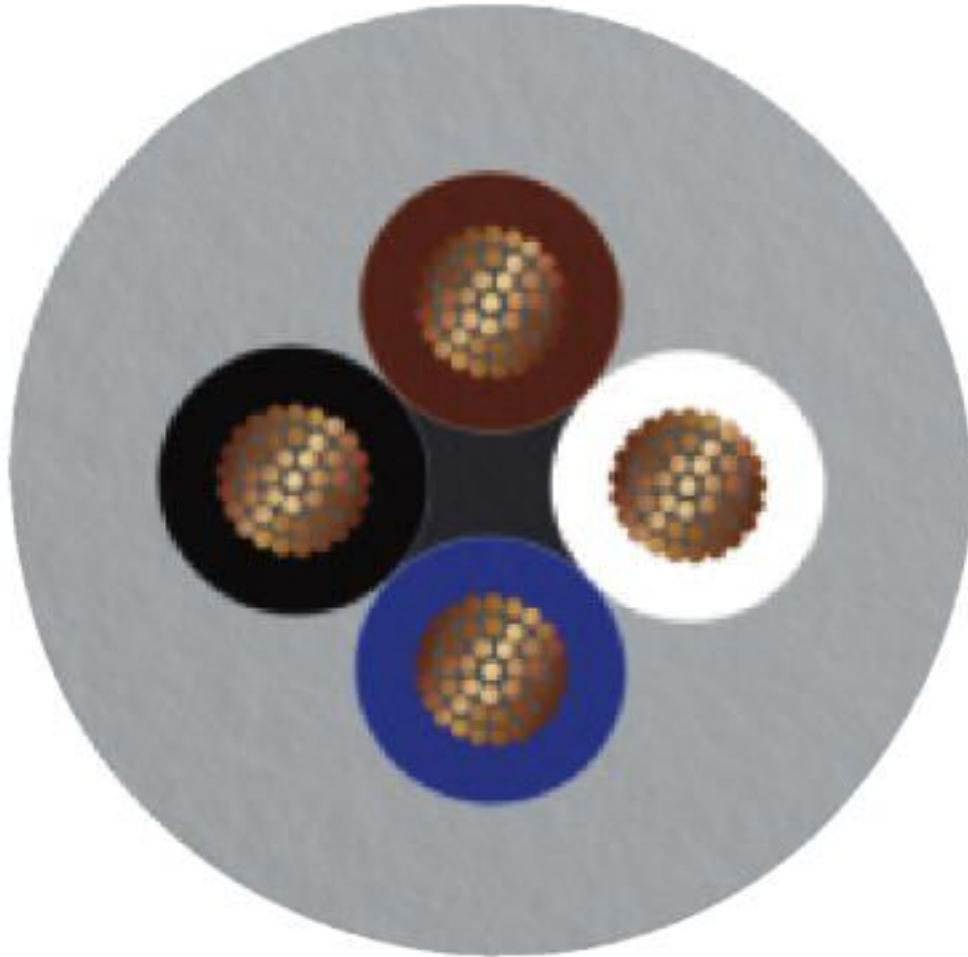

Gray, highly flexible PUR [800]

Classifications

eCl@ss

eCl@ss 10.0.1	27060311
eCl@ss 4.0	27060300
eCl@ss 4.1	27060300
eCl@ss 5.0	27061800
eCl@ss 5.1	27061800
eCl@ss 6.0	27279200
eCl@ss 7.0	27279218
eCl@ss 8.0	27279218
eCl@ss 9.0	27060311

Sensor/actuator cable - SAC-4P-M12MS/1,5-800/M12FR-3L - 1567199

Classifications

ETIM

ETIM 3.0	EC001855
ETIM 4.0	EC001855
ETIM 5.0	EC001855
ETIM 6.0	EC001855
ETIM 7.0	EC001855

UNSPSC

UNSPSC 6.01	31251501
UNSPSC 7.0901	31251501
UNSPSC 11	31251501
UNSPSC 12.01	31251501
UNSPSC 13.2	31251501
UNSPSC 19.0	31251501
UNSPSC 20.0	31251501
UNSPSC 21.0	31251501

Approvals

Approvals

Approvals

UL Listed / cUL Listed / EAC-RoHS / EAC / cULus Listed

Ex Approvals

Approval details

UL Listed		http://database.ul.com/cgi-bin/XYV/template/LISEXT/1FRAME/index.htm	FILE E 221474
Nominal voltage UN	24 V		
Nominal current IN	4 A		

cUL Listed		http://database.ul.com/cgi-bin/XYV/template/LISEXT/1FRAME/index.htm	FILE E 221474
Nominal voltage UN	24 V		
Nominal current IN	4 A		

Sensor/actuator cable - SAC-4P-M12MS/1,5-800/M12FR-3L - 1567199

Approvals

EAC-RoHS		RU D- DE.HB35.B.00387
----------	--	--------------------------

EAC		EAC-Zulassung
-----	--	---------------

cULus Listed		
--------------	--	--

Accessories

Accessories

Plug for cable screw gland

Screw plug - PROT-M12 MS-PA-CHAIN - 1430899

M12 sealing cap with fixing band, for sensor cables, for free M12 sockets



Protective cap

Sealing cap - PROT-M12 FS-PA-CHAIN - 1430873

M12 sealing cap made of plastic with fixing band, for sensor cables, for free M12 plugs



Screwdriver tools

Tool - SAC BIT M12-D15 - 1208432



Nut for assembling sensor/actuator cables with M12 connector and M12 connectors for assembly, with a knurl diameter of 15 mm, for 4 mm hexagonal drive

Torque tool

Sensor/actuator cable - SAC-4P-M12MS/1,5-800/M12FR-3L - 1567199

Accessories

Torque screwdriver - TSD 04 SAC - 1208429



Torque screwdriver, with preset torque of 0.4 Nm and 4 mm hexagonal drive for M12 connectors

Phoenix Contact 2020 © - all rights reserved
<http://www.phoenixcontact.com>

PHOENIX CONTACT GmbH & Co. KG
Flachsmarktstr. 8
32825 Blomberg
Germany
Tel. +49 5235 300
Fax +49 5235 3 41200
<http://www.phoenixcontact.com>

X-ON Electronics

Largest Supplier of Electrical and Electronic Components

Click to view similar products for [Sensor Cables / Actuator Cables](#) category:

Click to view products by [Phoenix Contact](#) manufacturer:

Other Similar products are found below :

[60963](#) [60964](#) [703000D02F2002](#) [703001D02F0602](#) [703001D02F300](#) [704000D02F120](#) [773032K02F030](#) [802027107404-1](#) [802027213811-1](#)
[804001A09M150](#) [805001A09M0502](#) [84914-0235](#) [84914-0237](#) [885030A09M020](#) [8R4J30E03C3003](#) [1200651332](#) [1200651713](#) [1200660844](#)
[1200660845](#) [1200661173](#) [1200680071](#) [1200720053](#) [1200720081](#) [1200720099](#) [1200720217](#) [1200800231](#) [1200860125](#) [1200870123](#)
[1200980102](#) [1200650267](#) [1200650298](#) [1200660183](#) [1200660782](#) [1200660849](#) [1200661295](#) [1200661297](#) [1200661342](#) [1200661343](#)
[1200670080](#) [1200670220](#) [1200680331](#) [1200720252](#) [1200730184](#) [1200860344](#) [1200870359](#) [1200870643](#) [1200980008](#) [1200980031](#)
[1210502211](#) [1210400542](#)