

Bus system cable - SAC-4P-M12MSD/ 2,0-931/M12FSD - 1569537

Please be informed that the data shown in this PDF Document is generated from our Online Catalog. Please find the complete data in the user's documentation. Our General Terms of Use for Downloads are valid (<http://phoenixcontact.com/download>)



Bus system cable, Ethernet CAT5 (100 Mbps), 4-position, PUR halogen-free, water blue RAL 5021, shielded, Plug straight M12, coding: D, on Socket straight M12, coding: D, cable length: 2 m



Ethernet

Key Commercial Data

Packing unit	1 pc
GTIN	 4 046356 336444
GTIN	4046356336444

Technical data

Dimensions

Length of cable	2 m
-----------------	-----

Ambient conditions

Ambient temperature (operation)	-25 °C ... 90 °C (Plug / socket)
Degree of protection	IP65
	IP67

General

Rated current at 40°C	4 A (Plug/socket in accordance with IEC 61076-2-101, cable technical data is to be observed)
Rated voltage	48 V AC 60 V DC
Number of positions	4
Color handle area	black
Insulation resistance	≥ 100 MΩ
Coding	D - data
Signal type/category	Ethernet CAT5, 100 Mbps
Status display	No
Overvoltage category	II

Bus system cable - SAC-4P-M12MSD/ 2,0-931/M12FSD - 1569537

Technical data

General

Degree of pollution	3
Insertion/withdrawal cycles	≥ 100
Transmission characteristics (category)	CAT5

Material

Flammability rating according to UL 94	V0
Contact material	CuSn
Contact surface material	Ni/Au
Contact carrier material	PA 6.6
Material of grip body	TPU, hardly inflammable, self-extinguishing
Material, knurls	Zinc die-cast, nickel-plated
Sealing material	NBR

Standards and Regulations

Flammability rating according to UL 94	V0
--	----

Cable

Cable abbreviation	02YS(ST)C11Y
UL AWM style	20963 (80°C/30 V)
Cable structure	2x2xAWG26/7; SF/UTP
Conductor cross section	2x 2x 0.14 mm ²
AWG signal line	26
Conductor structure signal line	7x 0.16 mm
Core diameter including insulation	0.98 mm
Wire colors	white/orange-orange, white/green-green
Twisted pairs	2 cores to the pair
Overall twist	Two pairs with two fillers to the core
Shielding	Aluminum-coated foil, tinned copper braided shield
Optical shield covering	70 %
External sheath, color	water blue RAL 5021
Outer sheath thickness	1.2 mm
External cable diameter D	6.4 mm ±0.2 mm
Minimum bending radius, fixed installation	4 x D
Minimum bending radius, flexible installation	8 x D
Cable weight	42 kg/km
Tensile strength GRP	≤ 80 N
Outer sheath, material	PUR
Material conductor insulation	Foamed PE
Conductor material	Bare Cu litz wires
Standards/specifications	Electrical requirements EN 50288-2-2
Insulation resistance	≥ 500 MΩ*km
Loop resistance	≤ 290.00 Ω/km

Bus system cable - SAC-4P-M12MSD/ 2,0-931/M12FSD - 1569537

Technical data

Cable

Cable capacity	approx. 45 nF/km (at 1 kHz)
Wave impedance	100 Ω ±5 Ω (at 100 MHz)
Near end crosstalk attenuation (NEXT)	65.3 dB (with 1 MHz)
	56.3 dB (at 4 MHz)
	50.3 dB (at 10 MHz)
	47.2 dB (at 16 MHz)
	45.8 dB (at 20 MHz)
	42.9 dB (at 31.25 MHz)
	38.4 dB (at 62.5 MHz)
	35.3 dB (at 100 MHz)
Attenuation	3.2 dB (with 1 MHz)
	6 dB (at 4 MHz)
	9.5 dB (at 10 MHz)
	12.1 dB (at 16 MHz)
	13.6 dB (at 20 MHz)
	17.1 dB (at 31.25 MHz)
	24.8 dB (at 62.5 MHz)
	32 dB (at 100 MHz)
Return Loss	23 dB (at 4 MHz)
	24.1 dB (at 8 MHz)
	25 dB (at 10 MHz)
	25 dB (at 16 MHz)
	25 dB (at 20 MHz)
	23.6 dB (at 31.25 MHz)
	21.5 dB (at 62.5 MHz)
	20.1 dB (at 100 MHz)
Signal runtime	5.3 ns/m
Coupling resistance	≤ 100.00 mΩ/m (at 10 MHz)
Nominal voltage, cable	≤ 100 V (Peak value, not for high-power applications)
Test voltage Core/Core	700 V (50 Hz, 1 min.)
Test voltage Core/Shield	700 V (50 Hz, 1 min.)
Current carrying capacity of cable	2 A (according to DIN VDE 0891-1)
Flame resistance	according to IEC 60332-1-2
	in acc. to UL VW1
Halogen-free	according to IEC 60754-1
Resistance to oil	according to EN 60811-2-1
Ambient temperature (operation)	-40 °C ... 80 °C (cable, fixed installation)
	-20 °C ... 80 °C (cable, flexible installation)

Environmental Product Compliance

REACH SVHC	Lead 7439-92-1
------------	----------------

Bus system cable - SAC-4P-M12MSD/ 2,0-931/M12FSD - 1569537

Technical data

Environmental Product Compliance

China RoHS	Environmentally Friendly Use Period = 50 years
	For details about hazardous substances go to tab "Downloads", Category "Manufacturer's declaration"

Drawings

Dimensional drawing

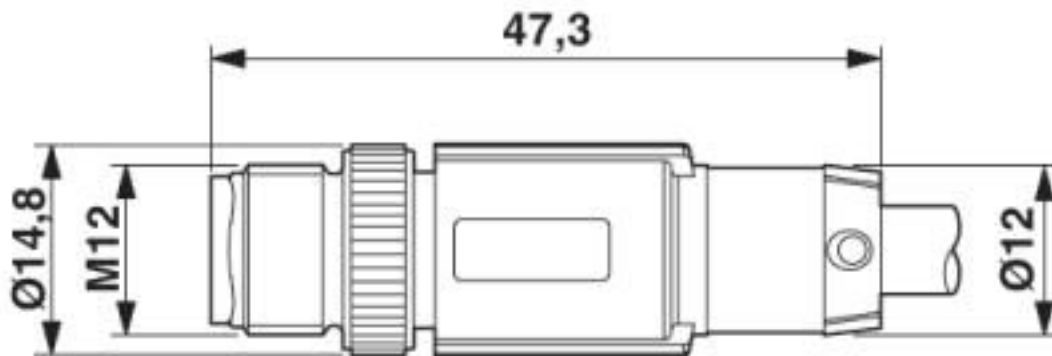

Plug, M12 x 1, straight, shielded

Dimensional drawing

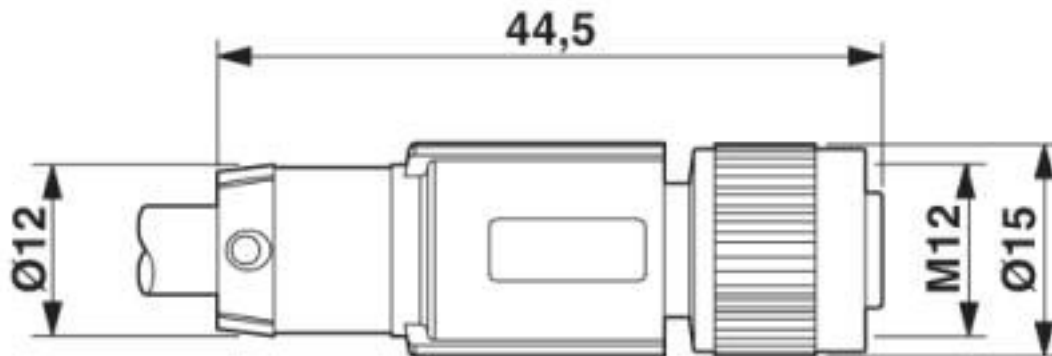

M12 x 1 socket, straight, shielded

Bus system cable - SAC-4P-M12MSD/ 2,0-931/M12FSD - 1569537

Circuit diagram

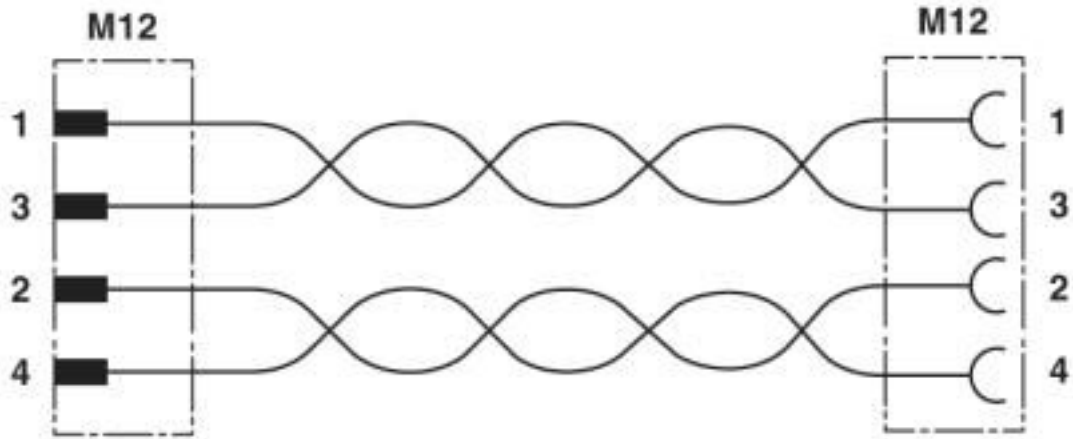

Schematic diagram

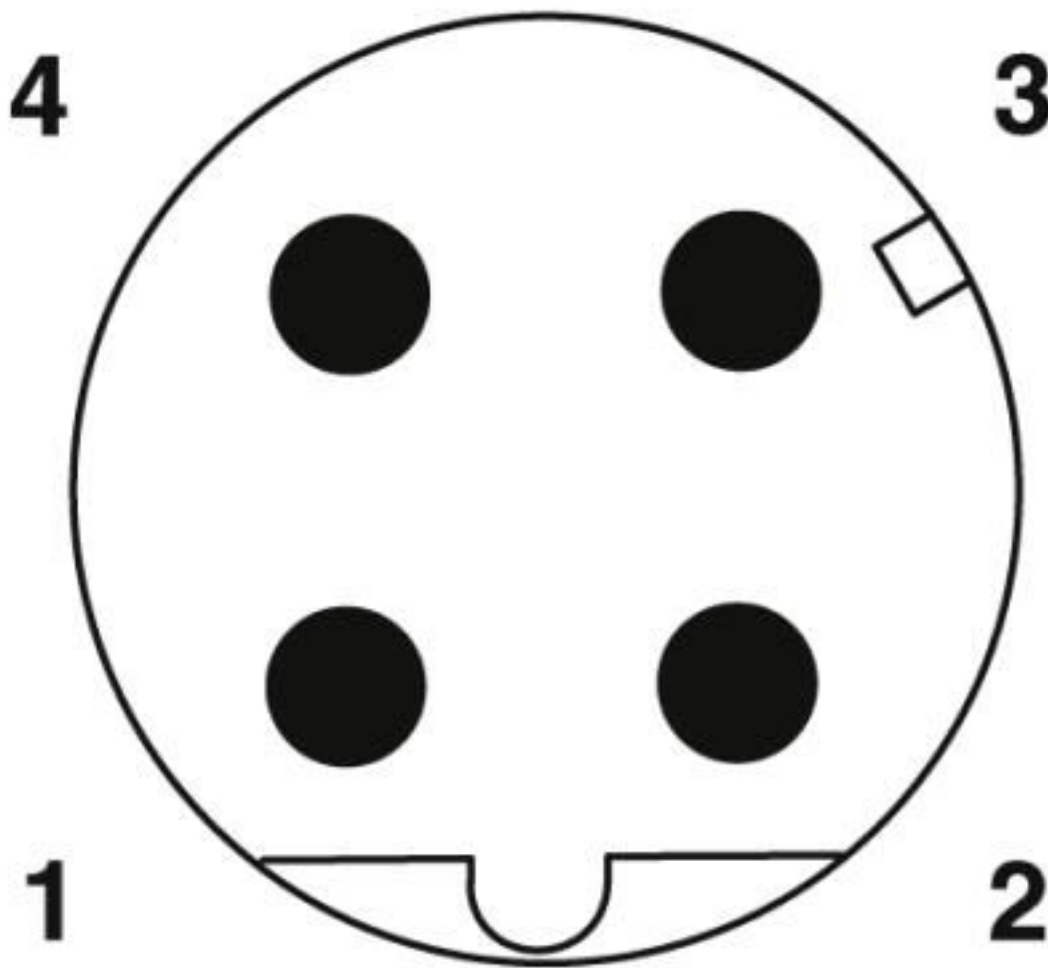

Pin assignment M12 male connector, 4-pos., D-coded, male side

Bus system cable - SAC-4P-M12MSD/ 2,0-931/M12FSD - 1569537

Schematic diagram

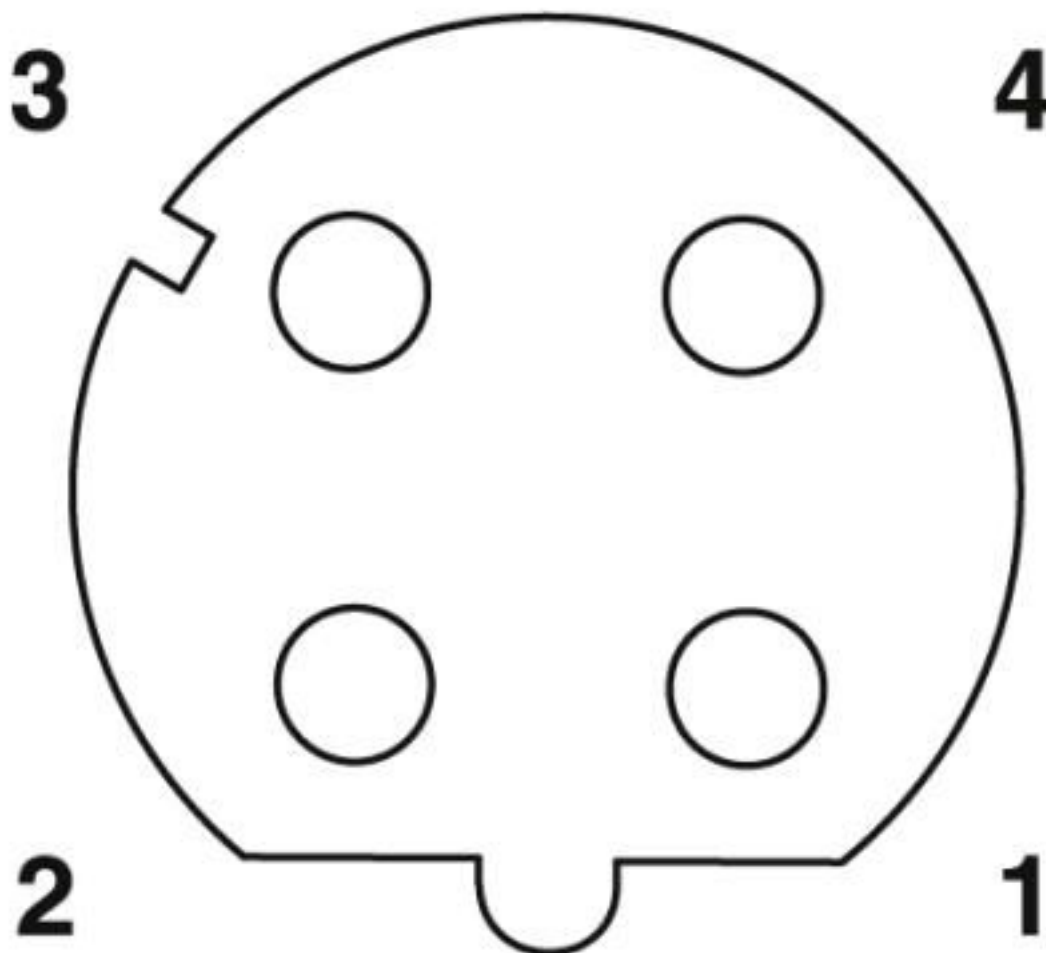

Pin assignment M12 socket, 4-pos., D-coded, female side

Bus system cable - SAC-4P-M12MSD/ 2,0-931/M12FSD - 1569537

Cable cross section

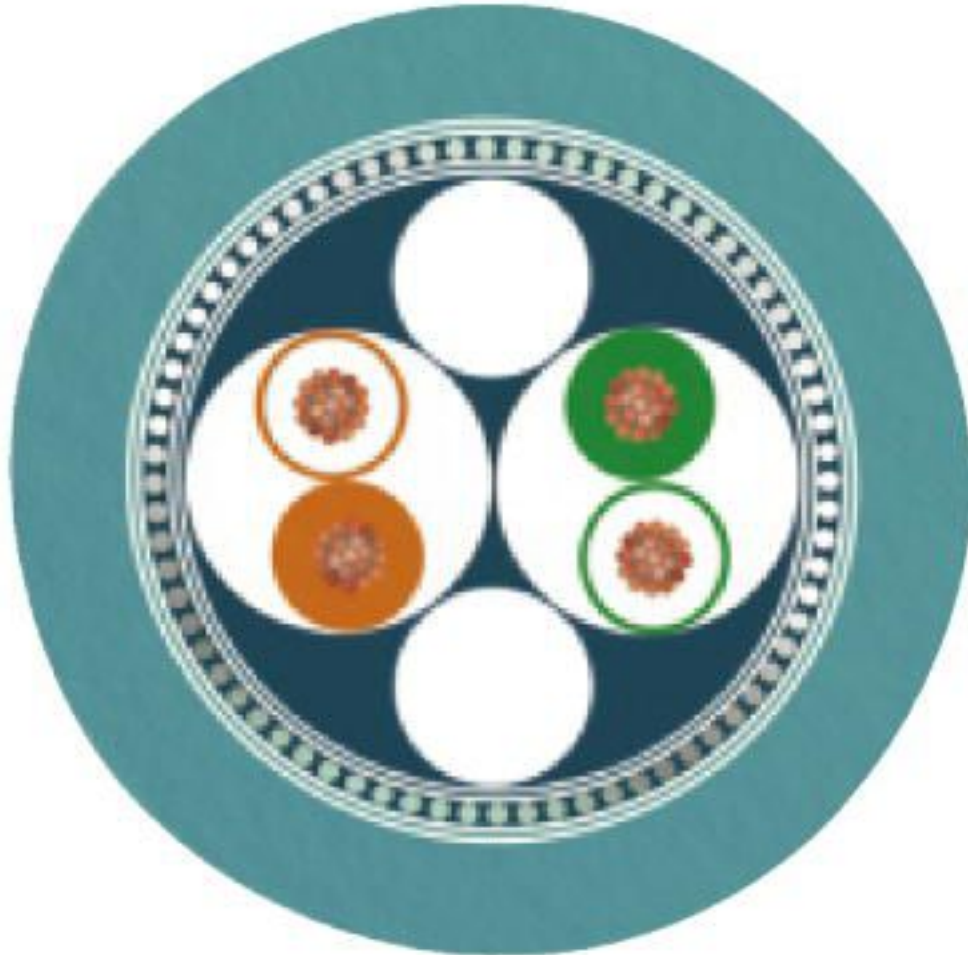

Ethernet flexible CAT5, 2-pair [93E]

Classifications

eCl@ss

eCl@ss 10.0.1	27060308
eCl@ss 4.0	27060300
eCl@ss 4.1	27060300
eCl@ss 5.0	27061800
eCl@ss 5.1	27061800
eCl@ss 6.0	27279200
eCl@ss 7.0	27279218
eCl@ss 8.0	27279218
eCl@ss 9.0	27060308

Bus system cable - SAC-4P-M12MSD/ 2,0-931/M12FSD - 1569537

Classifications

ETIM

ETIM 3.0	EC001855
ETIM 4.0	EC001855
ETIM 5.0	EC002599
ETIM 6.0	EC001262
ETIM 7.0	EC001262

UNSPSC

UNSPSC 6.01	31251501
UNSPSC 7.0901	31251501
UNSPSC 11	31251501
UNSPSC 12.01	31251501
UNSPSC 13.2	31251501
UNSPSC 18.0	26121604
UNSPSC 19.0	26121604
UNSPSC 20.0	26121604
UNSPSC 21.0	26121604

Approvals

Approvals

Approvals

EAC-RoHS / EAC

Ex Approvals

Approval details

EAC-RoHS		RU D- DE.HB35.B.00387
----------	--	--------------------------

EAC		RU C- DE.BL08.B.00286
-----	--	--------------------------

Phoenix Contact 2020 © - all rights reserved
<http://www.phoenixcontact.com>

PHOENIX CONTACT GmbH & Co. KG
Flachmarktstr. 8
32825 Blomberg
Germany
Tel. +49 5235 300
Fax +49 5235 3 41200
<http://www.phoenixcontact.com>

X-ON Electronics

Largest Supplier of Electrical and Electronic Components

Click to view similar products for [Ethernet Cables / Networking Cables](#) category:

Click to view products by [Phoenix Contact](#) manufacturer:

Other Similar products are found below :

[73-6670-7](#) [73-6680-15](#) [73-7797-25](#) [MCJB2-10P6Q7-120](#) [84909-0204](#) [1200700174](#) [1200860368](#) [E16A06002M030](#) [E200102-009-S1](#)
[AX105346-EW](#) [MT14-187L](#) [17-103530](#) [ERWPAB3002M005](#) [190-038045-01](#) [NK5EPC18RDY](#) [NK5EPC18VLY](#) [NK5EPC18YLY](#)
[NK5EPC1GRY](#) [NK5EPC4Y](#) [NK5EPC6YLY](#) [NK5EPC8BLY](#) [NK5EPC9YLY](#) [1969343-6](#) [C501100010](#) [C501106002](#) [C501106007](#)
[C501106015](#) [C501106025](#) [C601102010](#) [C601104010](#) [C601106007](#) [C601106015](#) [2142758-2](#) [2168427-2](#) [CAT1106007](#) [21949-1](#) [2J1866A](#)
[RJF SFTP 5E 0500](#) [AX100351](#) [MN14CEC/ST](#) [C501100015](#) [C501106004](#) [C501106010](#) [C5F1108007](#) [C601104004](#) [C601106004](#)
[CA21106004](#) [CA21106010](#) [CA21106015](#) [CA21109007](#)