

Contact insert - HC-DD108-I-CT-F - 1584130

Please be informed that the data shown in this PDF Document is generated from our Online Catalog. Please find the complete data in the user's documentation. Our General Terms of Use for Downloads are valid (<http://phoenixcontact.com/download>)



HEAVYCON female insert, DD108 series, 108-pos., crimp connection

Your advantages

- ✔ Can be used in rail vehicles, satisfy DIN EN 45545-2 with requirement sets R22, R23, and R24 in hazard levels HL1, HL2, and HL3.



Key Commercial Data

Packing unit	1 pc
GTIN	
GTIN	4046356133449

Technical data

General

Note	For housing HC-B24
	Connectors may be operated only when there is no load/voltage.
	It is imperative that guide pins (HC-CST) and sockets (HC-CBU) are used to prevent tip collision due to misalignment.
Connection method	Crimp connection
Torque	0.8 Nm ... 1.2 Nm (PE connection)
	0.5 Nm ... 0.8 Nm (Mounting screws for mounting in the HEAVYCON housing)
Number of connections per position	1
Degree of pollution	3
Overvoltage category	III
Number of positions	108+PE
Insertion/withdrawal cycles	≥ 500
Size	B24
	B48
Contact numbering	1 - 108

Contact insert - HC-DD108-I-CT-F - 1584130

Technical data

General

Conductor cross section	0.14 mm ² ... 2.5 mm ²
Connection cross section AWG	26 ... 14
Stripping length of the individual wire	8 mm (0.14 ... 1.5 mm ²)
	6 mm (2.5 mm ²)
Minimum housing height	72 mm
Assembly instructions	To ensure correct use, installation in housing with IP54 protection or better is required

Ambient conditions

Ambient temperature (operation)	-40 °C ... 125 °C (including heating up of contacts)
---------------------------------	--

Material data

Contact material	Copper alloy
Contact surface material	Ag (alternatively Au)
Contact carrier material	PC
Standards/regulations	PC: Fire protection in rail vehicles - requirement sets R22, R23, and R24 acc. to DIN EN 45545-2 (Risk level HL1 - HL3)

Electrical characteristics

Rated voltage (III/3)	250 V
Rated surge voltage	4 kV
Rated current	10 A

Standards and Regulations

Connection in acc. with standard	CSA
Constructional and testing regulations	DIN VDE 0627/86
	DIN VDE 0110/02.79
	DIN VDE 0110-1/04.97
	IEC 60664-1, DIN IEC 60512
	IEC 60352
Flammability rating according to UL 94	V0
Standards/regulations	acc. to DIN EN 45545-2

Environmental Product Compliance

China RoHS	Environmentally friendly use period: unlimited = EFUP-e
	No hazardous substances above threshold values

Drawings

Contact insert - HC-DD108-I-CT-F - 1584130

Schematic diagram

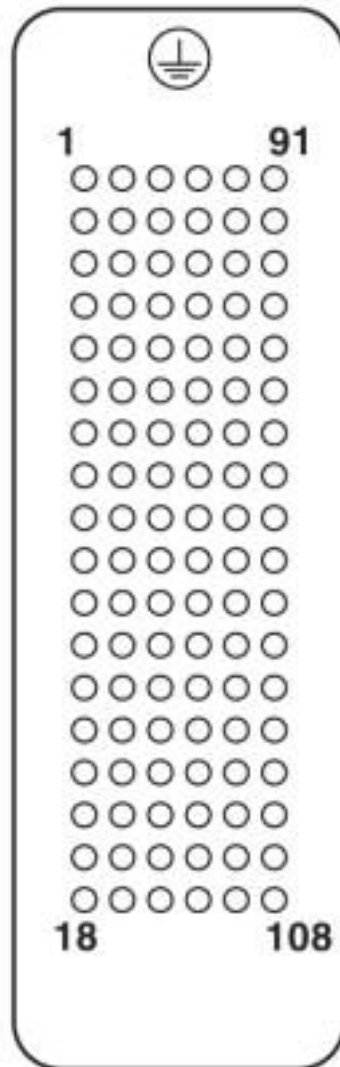

Connector pin assignment, connection side

Contact insert - HC-DD108-I-CT-F - 1584130

Diagram

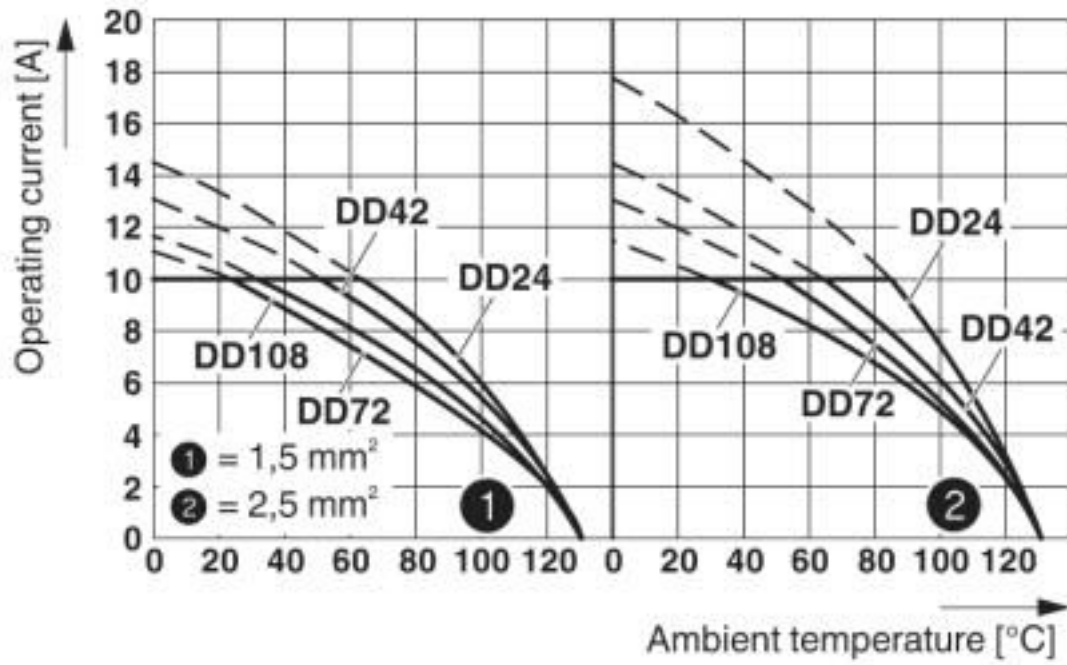

Derating diagram

Dimensional drawing

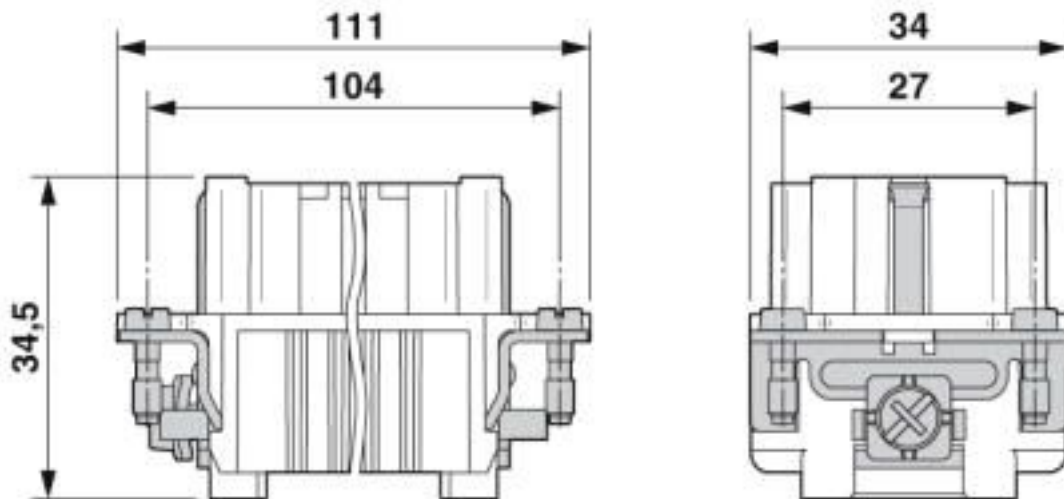

Female insert

Contact insert - HC-DD108-I-CT-F - 1584130

Dimensional drawing

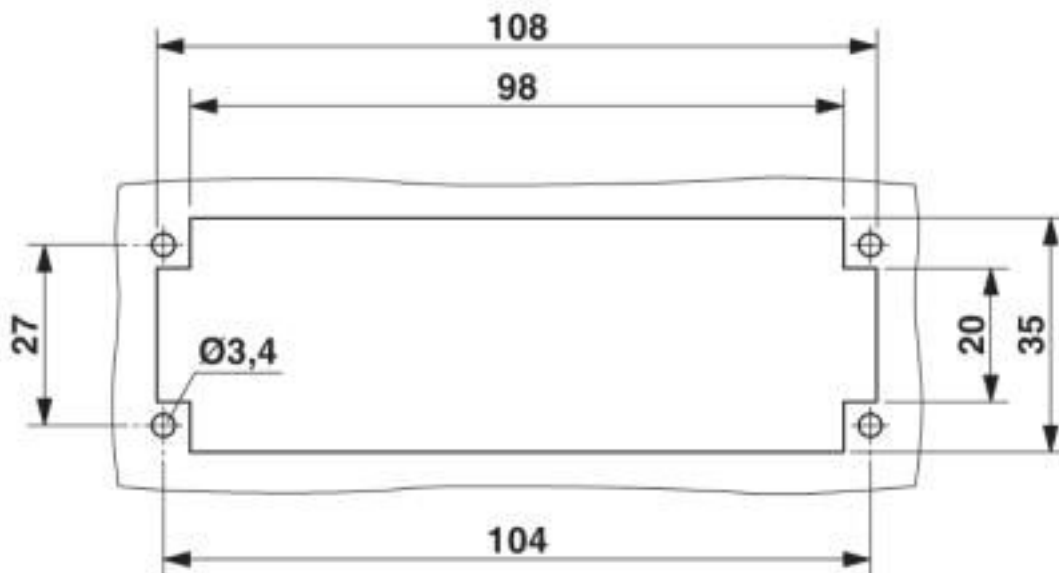

Mounting cutout when used without housing

Classifications

eCl@ss

eCl@ss 10.0.1	27440205
eCl@ss 4.0	27140800
eCl@ss 4.1	27140800
eCl@ss 5.0	27143400
eCl@ss 5.1	27261200
eCl@ss 6.0	27261200
eCl@ss 7.0	27440205
eCl@ss 8.0	27440205
eCl@ss 9.0	27440205

ETIM

ETIM 3.0	EC000438
ETIM 4.0	EC000437
ETIM 5.0	EC000438
ETIM 6.0	EC000438
ETIM 7.0	EC000438

UNSPSC

UNSPSC 6.01	30211923
UNSPSC 7.0901	39121522
UNSPSC 11	39121522
UNSPSC 12.01	39121522

Contact insert - HC-DD108-I-CT-F - 1584130

Classifications

UNSPSC

UNSPSC 13.2	39121522
UNSPSC 18.0	39121522
UNSPSC 19.0	39121522
UNSPSC 20.0	39121522
UNSPSC 21.0	39121522

Approvals

Approvals

Approvals

CSA / UL Recognized / cUL Recognized / EAC / DNV GL / EAC / cULus Recognized

Ex Approvals

Approval details

CSA		http://www.csagroup.org/services-industries/product-listing/	013631_6233_01
Nominal voltage UN		250 V	
Nominal current IN		7 A	
mm ² /AWG/kcmil		26-14	

UL Recognized		http://database.ul.com/cgi-bin/XYV/template/LISEXT/1FRAME/index.htm	FILE E 118976
Nominal voltage UN		250 V	
Nominal current IN		10 A	
mm ² /AWG/kcmil		14	

cUL Recognized		http://database.ul.com/cgi-bin/XYV/template/LISEXT/1FRAME/index.htm	FILE E 118976
Nominal voltage UN		250 V	
Nominal current IN		7 A	
mm ² /AWG/kcmil		14	

Contact insert - HC-DD108-I-CT-F - 1584130

Approvals

EAC		RU C- DE.AI30.B.01102
-----	--	--------------------------

DNV GL		https://approvalfinder.dnvgl.com/	TAE000037S
--------	--	---	------------

EAC		RU C- DE.BL08.B.00511
-----	--	--------------------------

cULus Recognized		
------------------	--	--

Accessories

Accessories

Assembly tool

Assembly tool - UNIFOX MT-CK 1.6/2.5 - 1089092



Assembly tool, for CK 1.6... crimp contacts for small conductor cross sections

Coding element

Coding element - HC-CBU - 1676860



Coding socket for coding up to 16 connectors

Coding element - HC-CST - 1676857



Coding peg for coding up to 16 connectors

Contact insert - HC-DD108-I-CT-F - 1584130

Accessories

Coding bolt - HC-CB - 1772722



Coding pin, prevents mismatching of up to six connectors with an identical number of positions

Crimp contact

Crimp contact - CK1,6-ED-0,37BU AG - 1663394



Turned 1.6 crimp contact, individual female contact, core diameter 0.14 to 0.37 mm², silver-plated

Crimp contact - CK1,6-ED-0,50BU AG - 1663404



Turned 1.6 crimp contact, individual female contact, core diameter 0.5 mm², silver-plated

Crimp contact - CK1,6-ED-0,75BU AG - 1663417



Turned 1.6 crimp contact, individual female contact, core diameter 0.75 mm², silver-plated

Crimp contact - CK1,6-ED-1,00BU AG - 1663420



Turned 1.6 crimp contact, individual female contact, core diameter 0.75 to 1.00 mm², silver-plated

Contact insert - HC-DD108-I-CT-F - 1584130

Accessories

Crimp contact - CK1,6-ED-1,50BU AG - 1663433



Turned 1.6 crimp contact, individual female contact, core diameter 1.5 mm², silver-plated

Crimp contact - CK1,6-ED-2,50BU AG - 1663446



Turned 1.6 crimp contact, individual female contact, core diameter 2.5 mm², silver-plated

Crimp contact - CK1,6-ED-0,37BU AU - 1674969



Turned 1.6 crimp contact, individual female contact, core diameter 0.14 to 0.37 mm², gold-plated

Crimp contact - CK1,6-ED-0,50BU AU - 1674480



Turned 1.6 crimp contact, individual female contact, core diameter 0.5 mm², gold-plated

Crimp contact - CK1,6-ED-0,75BU AU - 1672440



Turned 1.6 crimp contact, individual female contact, core diameter 0.75 mm², gold-plated

Contact insert - HC-DD108-I-CT-F - 1584130

Accessories

Crimp contact - CK1,6-ED-1,00BU AU - 1674943



Turned 1.6 crimp contact, individual female contact, core diameter 0.75 to 1.00 mm², gold-plated

Crimp contact - CK1,6-ED-1,50BU AU - 1674930



Turned 1.6 crimp contact, individual female contact, core diameter 1.5 mm², gold-plated

Crimp contact - CK1,6-ED-2,50BU AU - 1674985



Turned 1.6 crimp contact, individual female contact, core diameter 2.5 mm², gold-plated

Crimp contact - CK1,6-ER-1,00BU OIC AG - 1004362



Crimp contact, contact diameter: 1.6 mm, rolled, Socket, contact material: Cu alloy, nickel-plated, contact surface: silver-plated, connection cross section: 0.34 mm² ... 1 mm² AWG 22 ... 17

Crimp contact - CK1,6-ER-2,50BU OIC AG - 1004366



Crimp contact, contact diameter: 1.6 mm, rolled, Socket, contact material: Cu alloy, nickel-plated, contact surface: silver-plated, connection cross section: 1.5 mm² ... 2.5 mm² AWG 16 ... 14

Contact insert - HC-DD108-I-CT-F - 1584130

Accessories

Crimp contact - CK1,6-BR-1,00BU OIC AG - 1004381



Crimp contact, contact diameter: 1.6 mm, rolled, Socket, contact material: Cu alloy, nickel-plated, contact surface: silver-plated, connection cross section: 0.34 mm² ... 1 mm² AWG 22 ... 17

Crimp contact - CK1,6-BR-2,50BU OIC AG - 1004383



Crimp contact, contact diameter: 1.6 mm, rolled, Socket, contact material: Cu alloy, nickel-plated, contact surface: silver-plated, connection cross section: 1.5 mm² ... 2.5 mm² AWG 16 ... 14

Crimping tool

Crimping pliers - CRIMPFOX-TC 4 - 1212113



Crimping pliers, for CK 1,6-ED..., CK 2,5-ED..., CK 4,0-ED... turned contacts, 4 marked die stations, unlockable pressure lock, lateral entry, incl. positioning tool

Docking frame

Docking frames - HC-B 24-ANDOCK - 1586141



Docking frame for racks, for contact inserts of B24 type, with four M5 flat headed screws, rack balance x/y axis +/- 1.5 mm

Fiber optics contact

Female contact - CK1,6-ED-BU-POF - 1885004



POF fiber optic socket contact, turned, for contact carriers (HC-DD...I-CT.../ HC-M-12-CT-F.../ HC-M-17-CT-F...) of CK1,6-ED... contacts

Mounting material

Contact insert - HC-DD108-I-CT-F - 1584130

Accessories

Screw - HC-B-PES - 1604997



PE screw, for contact inserts HC-B / HC-BB / HC-DD / HC-D40 / HC-D64

PE multiplier - HC-B-3PE - 1644326



PE multiplier, for three PE connections, for HC-B (besides HC-B..E..ZZ) / HC-BB / HC-DD / HC-D40 / HC-D64 contact inserts

Strain relief clamp - HC-B-ZG - 1685327



Strain relief clamps contact inserts of series: B-, BB-, D 40, D 64, DD and HV, straight cable exit

Strain relief clamp - HC-B-ZS - 1685330



Strain relief clamps contact inserts of series: B-, BB-, D 40, D 64, DD and HV, lateral cable exit

Universal tools

Contact removal tool - UNIFOX RT-CK 1.6 - 1072069



Contact removal tool, for turned and rolled CK- 1.6-... contacts

Additional products

Contact insert - HC-DD108-I-CT-F - 1584130

Accessories

Contact insert - HC-DD108-I-CT-M - 1584114



HEAVYCON male insert, DD108 series, 108-pos., crimp connection

Phoenix Contact 2020 © - all rights reserved
<http://www.phoenixcontact.com>

PHOENIX CONTACT GmbH & Co. KG
Flachsmarktstr. 8
32825 Blomberg
Germany
Tel. +49 5235 300
Fax +49 5235 3 41200
<http://www.phoenixcontact.com>

X-ON Electronics

Largest Supplier of Electrical and Electronic Components

Click to view similar products for [Heavy Duty Power Connectors](#) category:

Click to view products by [Phoenix Contact](#) manufacturer:

Other Similar products are found below :

[647757-1](#) [6643411-1](#) [6646058-2](#) [6646137-1](#) [6646138-1](#) [6646479-1](#) [6646608-1](#) [6646786-1](#) [6646940-1](#) [6651091-1](#) [6651525-1](#) [6651529-1](#)
[6651788-1](#) [696475-1](#) [702-32-01109](#) [703-25-02205](#) [73000005059](#) [73000005642](#) [73080255059](#) [73080965046](#) [765-15-0080A](#) [765-16-0080B](#)
[765-18-0080D](#) [829992-1](#) [902-77-02113](#) [PS00/A0620/6300](#) [PS25/A0420/63](#) [129-1J](#) [1409400](#) [AN0024023](#) [E6374G1](#) [e6389g2](#) [157-43GW8](#)
[MS3117-14AC](#) [1643543-1](#) [1650540-1](#) [1651811-2](#) [1766260-1](#) [1766282-1](#) [1766966-1](#) [1791340000](#) [NLDFT-3-BL-L-S120-M40A](#) [NLDFT-N-](#)
[W-L-C240-M40B](#) [NLS-2-R-C240-M40B](#) [NLS-N-W-C240-M40B](#) [NPS-3-BL-T6](#) [1986615-1](#) [2-1589900-8](#) [2199314-1](#) [KA8102](#)