

Rear panel feed-through - SF-7EP1N8ACLB3 - 1607054

Please be informed that the data shown in this PDF Document is generated from our Online Catalog. Please find the complete data in the user's documentation. Our General Terms of Use for Downloads are valid (<http://phoenixcontact.com/download>)



Rear panel feed-through, straight long, Screw locking, M23, number of positions: 4+3+PE, type of contact: Pin, Axial O-ring, 4xM3, shielded: yes, cable diameter range: 9 mm ... 12 mm, number of positions: 8, connection method: Crimp connection

Your advantages

- ✓ Consistent EMC protection for reliable connection solutions in the industrial environment
- ✓ Crimping connection: vibration- and temperature-resistant assembly
- ✓ Flexible use: reliably connect various cable diameters



Key Commercial Data

Packing unit	1 pc
GTIN	 4 046356 253819
GTIN	4046356253819

Technical data

General

Note	Order information: Order crimp contacts 4 x Ø 1 mm, 4 x Ø 2 mm separately
Type of locking	Screw locking
Coding	N
Contact connection method	Crimp connection
Type of contacts	Pin
Number of positions	8
Contact diameter of power contacts	2 mm
Rated current for power contacts	30 A
Contact diameter of signal contacts	1 mm
Nominal current per signal contact	9 A
Conductor entry	9 mm ... 12 mm
Pg housing screw connection	none
Mounting type	4x M3

Rear panel feed-through - SF-7EP1N8ACLB3 - 1607054

Technical data

Ambient conditions

Ambient temperature	-40 °C ... 125 °C
Degree of protection	IP67

Material

Housing material	Turned parts: copper zinc alloy (CuZn), die-cast parts: zinc (GD-Zn)
Insulator material	PA 6.6
Gasket and O-ring material	FPM

Specifications according to DIN EN 61984:2001

Installation height max.	3000 m
Nominal / operating voltage of power contacts	630 V
Rated surge voltage of power contacts	6 kV
Overvoltage category of power contacts	III
Degree of pollution of power contacts	3
Nominal / operating voltage of signal contacts	630 V
Overvoltage category of signal contacts	III
Degree of pollution of signal contacts	3

Standards and Regulations

Safety note	WARNING: The connectors may not be plugged in or disconnected under load. Ignoring the warning or improper use may damage persons and/or property.
	• WARNING: Commission properly functioning products only. The products must be regularly inspected for damage. Decommission defective products immediately. Replace damaged products. Repairs are not possible.
	• WARNING: Only electrically qualified personnel may install and operate the product. They must observe the following safety notes. The qualified personnel must be familiar with the basics of electrical engineering. They must be able to recognize and prevent danger. The relevant symbol on the packaging indicates that only personnel familiar with electrical engineering are allowed to install and operate the product.
	• The products are suitable for applications in plant, controller, and electrical device engineering.
	• When operating the connectors in outdoor applications, they must be separately protected against environmental influences.
	• Assembled products may not be manipulated or improperly opened.
	• Only use mating connectors that are specified in the technical data of the standards listed (e.g. the ones listed in the product accessories online at phoenixcontact.com/products).
	• When using the product in direct connection with third-party manufacturers, the user is responsible.
	• For operating voltages > 50 V AC, conductive connector housings must be grounded
	• Ensure that the protective or functional ground has been properly connected.
	• VDE 0100/1.97 § 411.1.3.2 and DIN EN 60 204/11.98 § 14.1.3 are applicable when combining several circuits in a cable and/or connector

Rear panel feed-through - SF-7EP1N8ACLB3 - 1607054

Technical data

Standards and Regulations

	<ul style="list-style-type: none"> • Only use tools recommended by Phoenix Contact
	<ul style="list-style-type: none"> • The installation notes/Design In documents online on the download page at phoenixcontact.com/products must be observed for this product.
	<ul style="list-style-type: none"> • Operate the connector only when it is fully plugged in and interlocked.
	<ul style="list-style-type: none"> • Ensure that when laying the cable, the tensile load on the connectors does not exceed the upper limit specified in the standards.
	<ul style="list-style-type: none"> • Observe the minimum bending radius of the cable. Lay the cable without twisting it.
	<ul style="list-style-type: none"> • The connector warms up in normal operation. Depending on the ambient conditions, the surface of the connector can continue to warm up. In this case, the user is responsible for posting warnings (e.g. DIN EN ISO 13732-1:2008-12).

Environmental Product Compliance

REACH SVHC	Lead 7439-92-1
China RoHS	Environmentally Friendly Use Period = 50 years
	For details about hazardous substances go to tab "Downloads", Category "Manufacturer's declaration"

Drawings

Rear panel feed-through - SF-7EP1N8ACLB3 - 1607054

Dimensional drawing

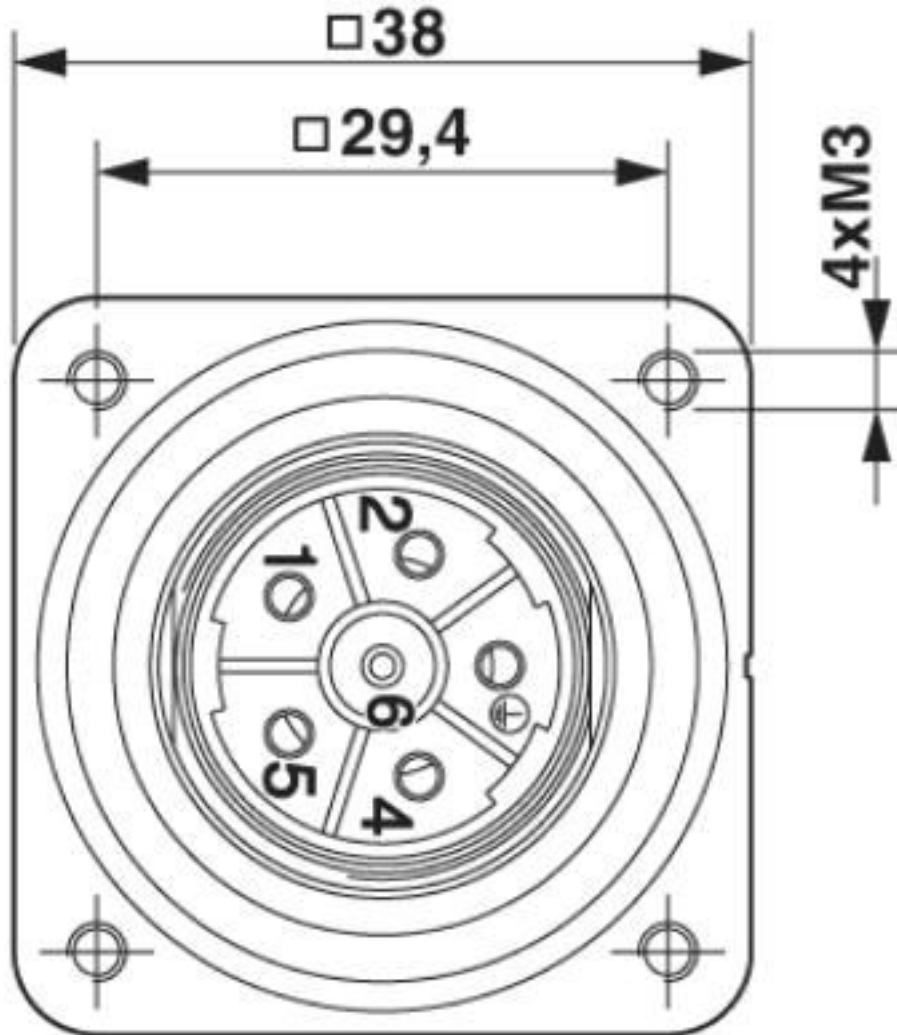

Flange dimensions (Figure shows the 6-pos. version)

Rear panel feed-through - SF-7EP1N8ACLB3 - 1607054

Schematic diagram

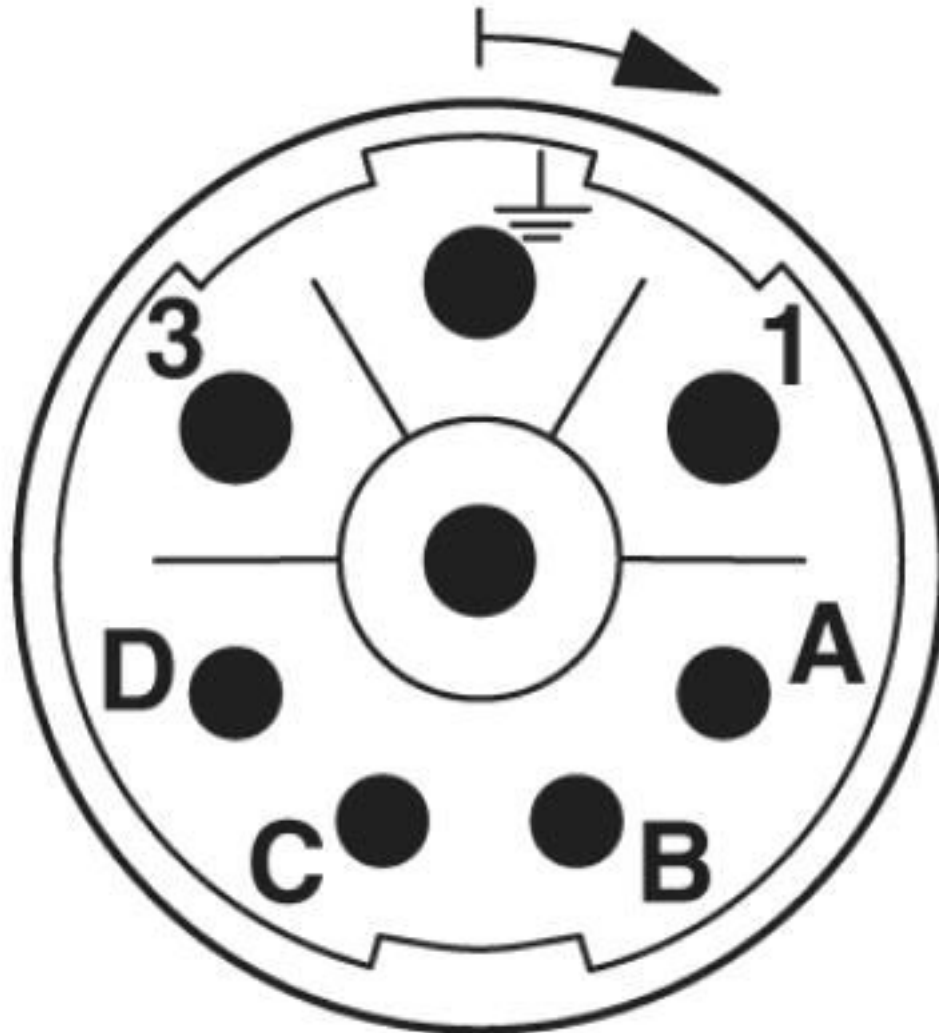

Connector pin assignment

Rear panel feed-through - SF-7EP1N8ACLB3 - 1607054

Diagram

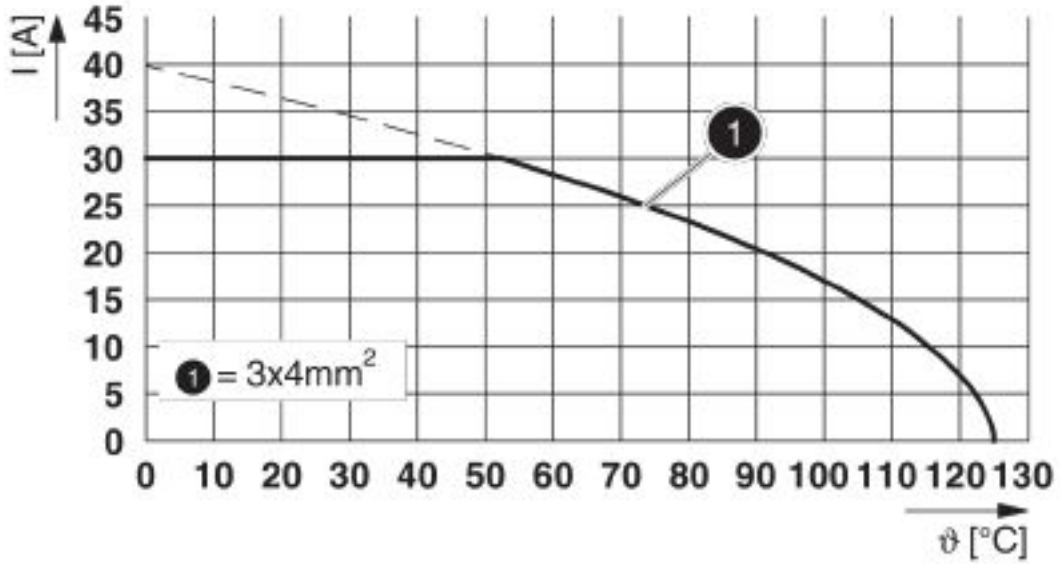

I = current strength, T = ambient temperature

Rear panel feed-through - SF-7EP1N8ACLB3 - 1607054

Dimensional drawing

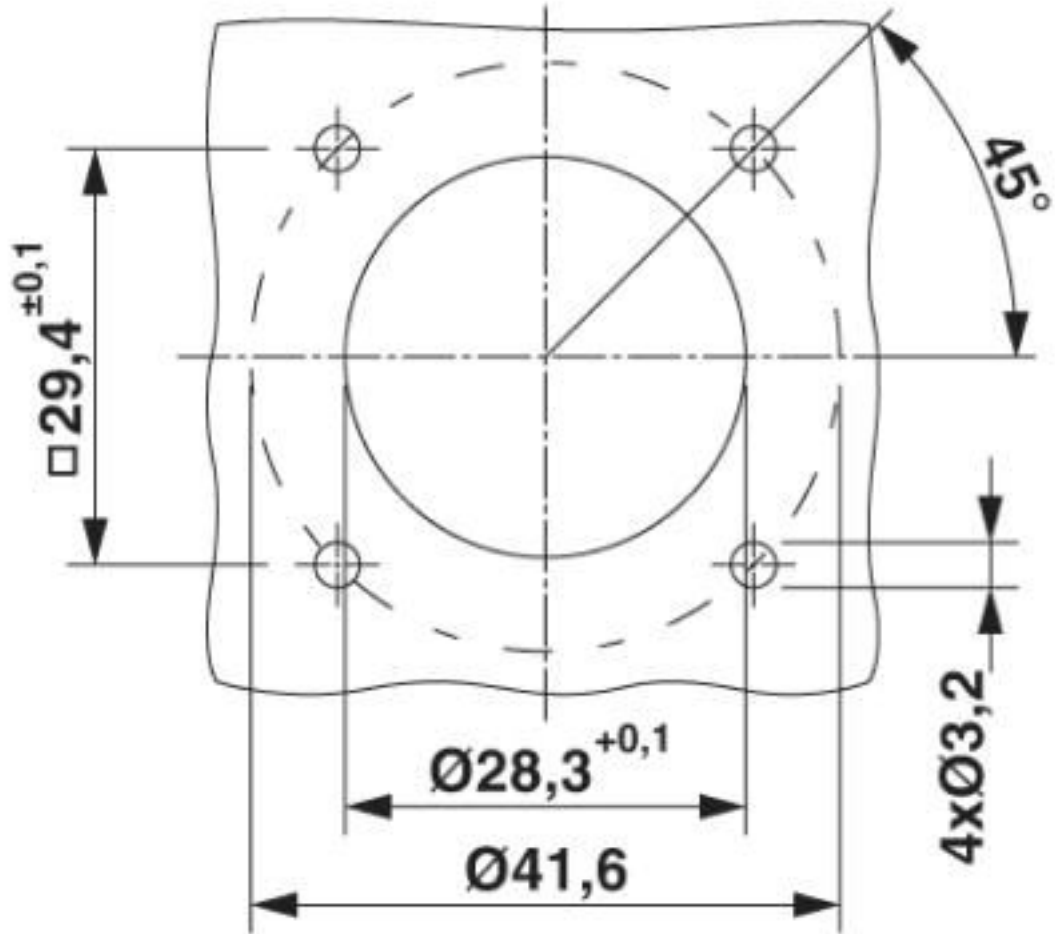

Installation dimensions

Rear panel feed-through - SF-7EP1N8ACLB3 - 1607054

Dimensional drawing

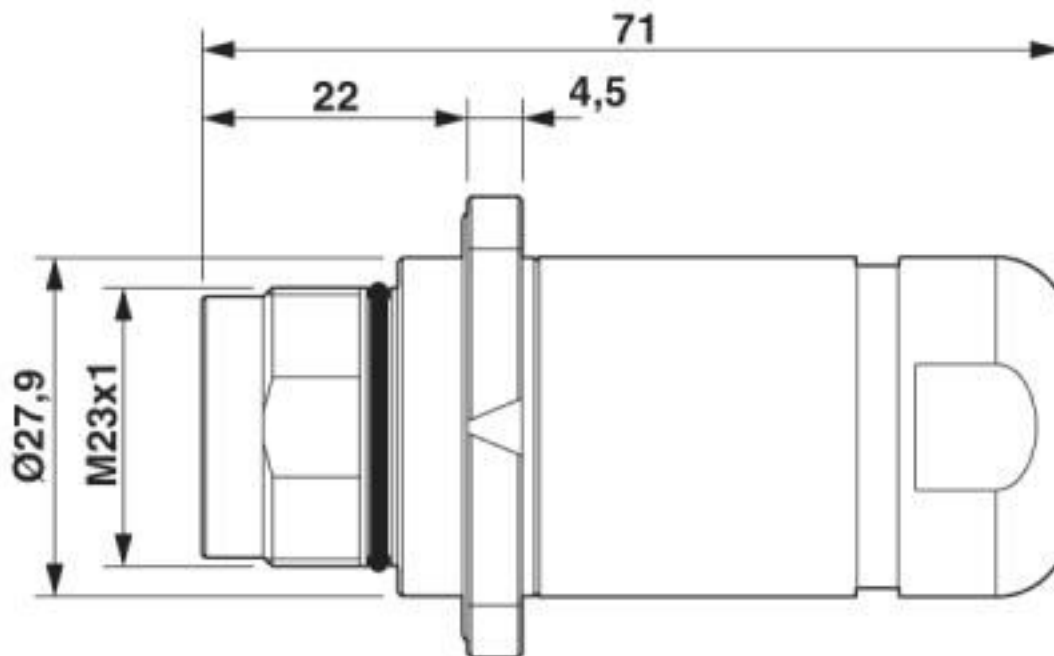

Dimensional drawing

Classifications

eCl@ss

eCl@ss 10.0.1	27440102
eCl@ss 4.0	27260700
eCl@ss 4.1	27260700
eCl@ss 5.0	27260700
eCl@ss 5.1	27260700
eCl@ss 6.0	27279200
eCl@ss 7.0	27440103
eCl@ss 8.0	27440103
eCl@ss 9.0	27440102

ETIM

ETIM 3.0	EC001121
ETIM 4.0	EC001121
ETIM 5.0	EC002061
ETIM 6.0	EC002061

UNSPSC

UNSPSC 6.01	43172015
UNSPSC 7.0901	43201404
UNSPSC 11	43172015

Rear panel feed-through - SF-7EP1N8ACLB3 - 1607054

Classifications

UNSPSC

UNSPSC 12.01	43201404
UNSPSC 13.2	39121413
UNSPSC 18.0	39121413
UNSPSC 19.0	39121413
UNSPSC 20.0	39121413
UNSPSC 21.0	39121413

Approvals

Approvals

Approvals

UL Recognized / cUL Recognized / EAC / cULus Recognized

Ex Approvals

Approval details

UL Recognized		http://database.ul.com/cgi-bin/XYV/template/LISEXT/1FRAME/index.htm E153698-20041116
Nominal voltage UN	600 V	
Nominal current IN	27 A	
mm ² /AWG/kcmil	12	

cUL Recognized		http://database.ul.com/cgi-bin/XYV/template/LISEXT/1FRAME/index.htm E153698-20041116
Nominal voltage UN	600 V	
Nominal current IN	18 A	
mm ² /AWG/kcmil	12	

EAC		B.01687
-----	---	---------

Rear panel feed-through - SF-7EP1N8ACLB3 - 1607054

Approvals

cULus Recognized



Accessories

Accessories

Crimp contact

Crimp contact - SF-7RP2000 - 1605646



Crimp contact, turned, Single contact, contact diameter: 2 mm, crimp range: 0.14 mm² ... 0.25 mm²

Crimp contact - SF-7PP2000 - 1605634



Crimp contact, turned, Single contact, contact diameter: 2 mm, crimp range: 0.25 mm² ... 1 mm²

Crimp contact - SF-20KP004 - 1607376



Crimp contact, turned, contact diameter: 2 mm, crimp range: 0.75 mm² ... 1.5 mm²

Crimp contact - SF-7QP2000 - 1605639



Crimp contact, turned, Single contact, contact diameter: 2 mm, crimp range: 1 mm² ... 2.5 mm²

Rear panel feed-through - SF-7EP1N8ACLB3 - 1607054

Accessories

Crimp contact - SF-7MP2000 - 1605626



Crimp contact, turned, Single contact, contact diameter: 2 mm, crimp range: 4 mm² ... 4 mm²

Crimp contact - SF-6CP2000 - 1605559



Crimp contact, turned, Single contact, contact diameter: 1 mm, crimp range: 0.06 mm² ... 0.25 mm²

Crimp contact - SF-10KP004 - 1607355



Crimp contact, turned, Single contact, contact diameter: 1 mm, crimp range: 0.14 mm² ... 0.5 mm²

Crimp contact - SF-6AP2000 - 1605554



Crimp contact, turned, Single contact, contact diameter: 1 mm, crimp range: 0.25 mm² ... 1 mm²

Mounting material

Color-coding - SF-Z0064 - 1620585



Color-coding, color: green

Rear panel feed-through - SF-7EP1N8ACLB3 - 1607054

Accessories

Color-coding - SF-Z0065 - 1620586



Color-coding, color: orange

Color-coding - SF-Z0066 - 1620587



Color-coding, color: black

Protective cover

Protective cap - SF-Z0019 - 1607449



Plastic protection cap, with eye, IP40 for connectors with M23 external thread, RF, SF series

Protective cap - RC-Z2059 - 1604225



Plastic protection cap for connectors with M23 external thread

Plastic anti-static dust protection cap - RC-Z2469 - 1611797



Plastic protection cap, antistatic, for RF, SF, CA, RC series connectors, with M23 external thread

Rear panel feed-through - SF-7EP1N8ACLB3 - 1607054

Accessories

Metal protective cap - SC-Z2319 - 1605456



Metal protection cap for power connectors with M23 external thread

Metal protective cap - SC-Z2320 - 1605457



Metal protection cap with steel wire for power connectors with M23 external thread

Phoenix Contact 2020 © - all rights reserved
<http://www.phoenixcontact.com>

PHOENIX CONTACT GmbH & Co. KG
Flachsmarktstr. 8
32825 Blomberg
Germany
Tel. +49 5235 300
Fax +49 5235 3 41200
<http://www.phoenixcontact.com>

X-ON Electronics

Largest Supplier of Electrical and Electronic Components

Click to view similar products for [Circular Metric Connectors](#) category:

Click to view products by [Phoenix Contact](#) manufacturer:

Other Similar products are found below :

[600X518037X](#) [6STD15PCR99B70A](#) [8R4000A16M020](#) [8R5000A16M005](#) [1200910002](#) [1203580030](#) [1200910008](#) [1200910011](#) [1300140094](#)
[130203-0054](#) [1300140026](#) [1300150099](#) [RF-12S1N8A90DU](#) [1-3637-600-5205](#) [1612618](#) [21036836414](#) [8R4006A16M010](#) [1604232](#)
[1R3006A20M005](#) [RF-12P1N8A90DU](#) [41-40011](#) [42-00006](#) [42-01015](#) [4-22279-4](#) [4-22281-1](#) [4-22284-9](#) [43-00113](#) [43-01088](#) [43-01203](#) [41-](#)
[40013](#) [42-00008](#) [43-00343](#) [43-01026](#) [43-01162](#) [43-01173](#) [43-10000](#) [XS3P-M421-2](#) [600X518050X](#) [SACC-DSI-FS-5P-PG9-L180 SC](#)
[8R5006A16M020](#) [8R5006A16M005](#) [8R4000A16M010](#) [6-22279-3](#) [1605332](#) [N03FA03144](#) [1300140077](#) [43-16213](#) [43-01338](#) [XS2RD4265](#)
[XS2R-D426-1](#)