

## Device connector, front mounting - SM-7EPWN8AA200 - 1613526

Please be informed that the data shown in this PDF Document is generated from our Online Catalog. Please find the complete data in the user's documentation. Our General Terms of Use for Downloads are valid (<http://phoenixcontact.com/download>)



Device connector, front mounting, Angled fixed for higher loads, SPEEDCON locking, M40, number of positions: 4+3+PE, type of contact: Pin, Axial O-ring, 4x Ø4,2, shielded: yes, flange dimensions: 40 mm x 40 mm, number of positions: 8, connection method: Crimp connection



### Key Commercial Data

Packing unit	6 pc
GTIN	
GTIN	4046356400848

### Technical data

#### General

Note	Order information: Order crimp contacts 4 x Ø 2 mm, 4 x Ø 3.6 mm separately
Type of locking	SPEEDCON locking
Coding	N
Contact connection method	Crimp connection
Type of contacts	Pin
Number of positions	8
Contact diameter of power contacts	3.6 mm
Rated current for power contacts	70 A
Contact diameter of signal contacts	2 mm
Nominal current per signal contact	30 A
Pg housing screw connection	none
Mounting type	4x Ø4,2

#### Ambient conditions

Ambient temperature	-40 °C ... 125 °C
Degree of protection	IP67

#### Material

# Device connector, front mounting - SM-7EPWN8AA200 - 1613526

## Technical data

### Material

Housing material	Turned parts: copper zinc alloy (CuZn), die-cast parts: zinc (GD-Zn)
Insulator material	PA 6.6
Gasket and O-ring material	FPM

### Specifications according to DIN EN 61984:2001

Installation height max.	3000 m
Nominal / operating voltage of power contacts	630 V
Rated surge voltage of power contacts	6 kV
Overvoltage category of power contacts	III
Degree of pollution of power contacts	3
Nominal / operating voltage of signal contacts	250 V
Rated surge voltage of signal contacts	4 kV
Overvoltage category of signal contacts	III
Degree of pollution of signal contacts	3

### Standards and Regulations

Safety note	WARNING: The connectors may not be plugged in or disconnected under load. Ignoring the warning or improper use may damage persons and/or property.
	• WARNING: Commission properly functioning products only. The products must be regularly inspected for damage. Decommission defective products immediately. Replace damaged products. Repairs are not possible.
	• WARNING: Only electrically qualified personnel may install and operate the product. They must observe the following safety notes. The qualified personnel must be familiar with the basics of electrical engineering. They must be able to recognize and prevent danger. The relevant symbol on the packaging indicates that only personnel familiar with electrical engineering are allowed to install and operate the product.
	• The products are suitable for applications in plant, controller, and electrical device engineering.
	• When operating the connectors in outdoor applications, they must be separately protected against environmental influences.
	• Assembled products may not be manipulated or improperly opened.
	• Only use mating connectors that are specified in the technical data of the standards listed (e.g. the ones listed in the product accessories online at phoenixcontact.com/products).
	• When using the product in direct connection with third-party manufacturers, the user is responsible.
	• For operating voltages > 50 V AC, conductive connector housings must be grounded
	• Ensure that the protective or functional ground has been properly connected.
	• VDE 0100/1.97 § 411.1.3.2 and DIN EN 60 204/11.98 § 14.1.3 are applicable when combining several circuits in a cable and/or connector
	• Only use tools recommended by Phoenix Contact
	• The installation notes/Design In documents online on the download page at phoenixcontact.com/products must be observed for this product.

## Device connector, front mounting - SM-7EPWN8AA200 - 1613526

### Technical data

#### Standards and Regulations

	<ul style="list-style-type: none"><li>• Operate the connector only when it is fully plugged in and interlocked.</li></ul>
	<ul style="list-style-type: none"><li>• Ensure that when laying the cable, the tensile load on the connectors does not exceed the upper limit specified in the standards.</li></ul>
	<ul style="list-style-type: none"><li>• Observe the minimum bending radius of the cable. Lay the cable without twisting it.</li></ul>
	<ul style="list-style-type: none"><li>• The connector warms up in normal operation. Depending on the ambient conditions, the surface of the connector can continue to warm up. In this case, the user is responsible for posting warnings (e.g. DIN EN ISO 13732-1:2008-12).</li></ul>

#### Environmental Product Compliance

REACH SVHC	Lead 7439-92-1
China RoHS	Environmentally Friendly Use Period = 50 years
	For details about hazardous substances go to tab "Downloads", Category "Manufacturer's declaration"

### Drawings

# Device connector, front mounting - SM-7EPWN8AA200 - 1613526

Dimensional drawing

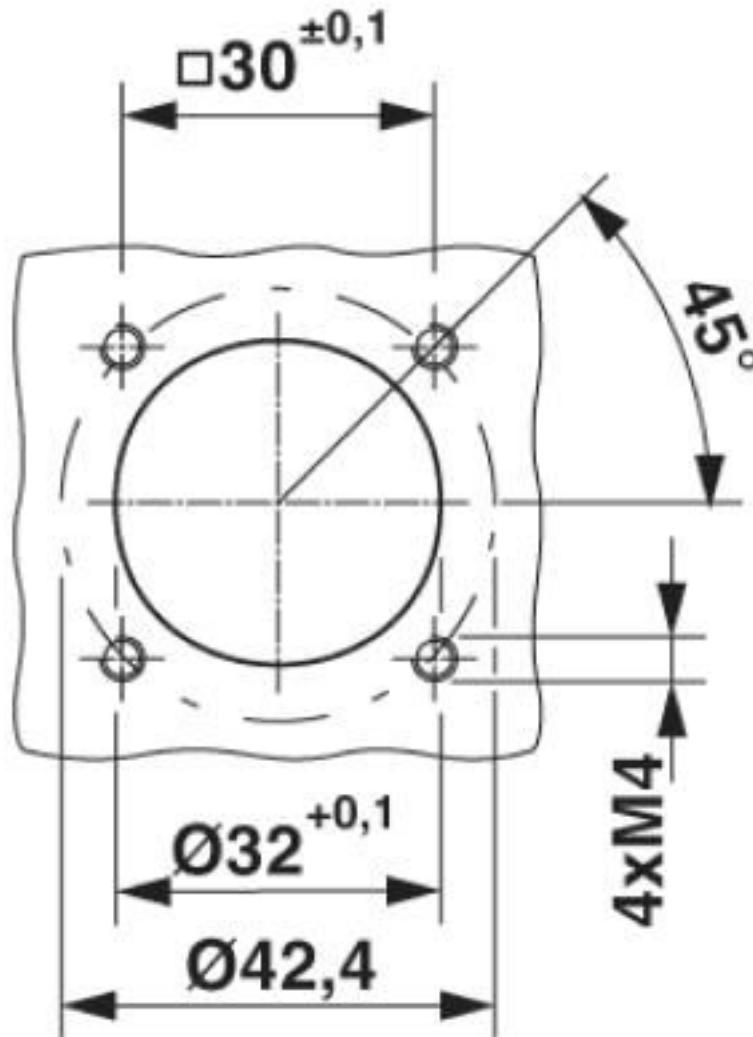

# Device connector, front mounting - SM-7EPWN8AA200 - 1613526

Schematic diagram

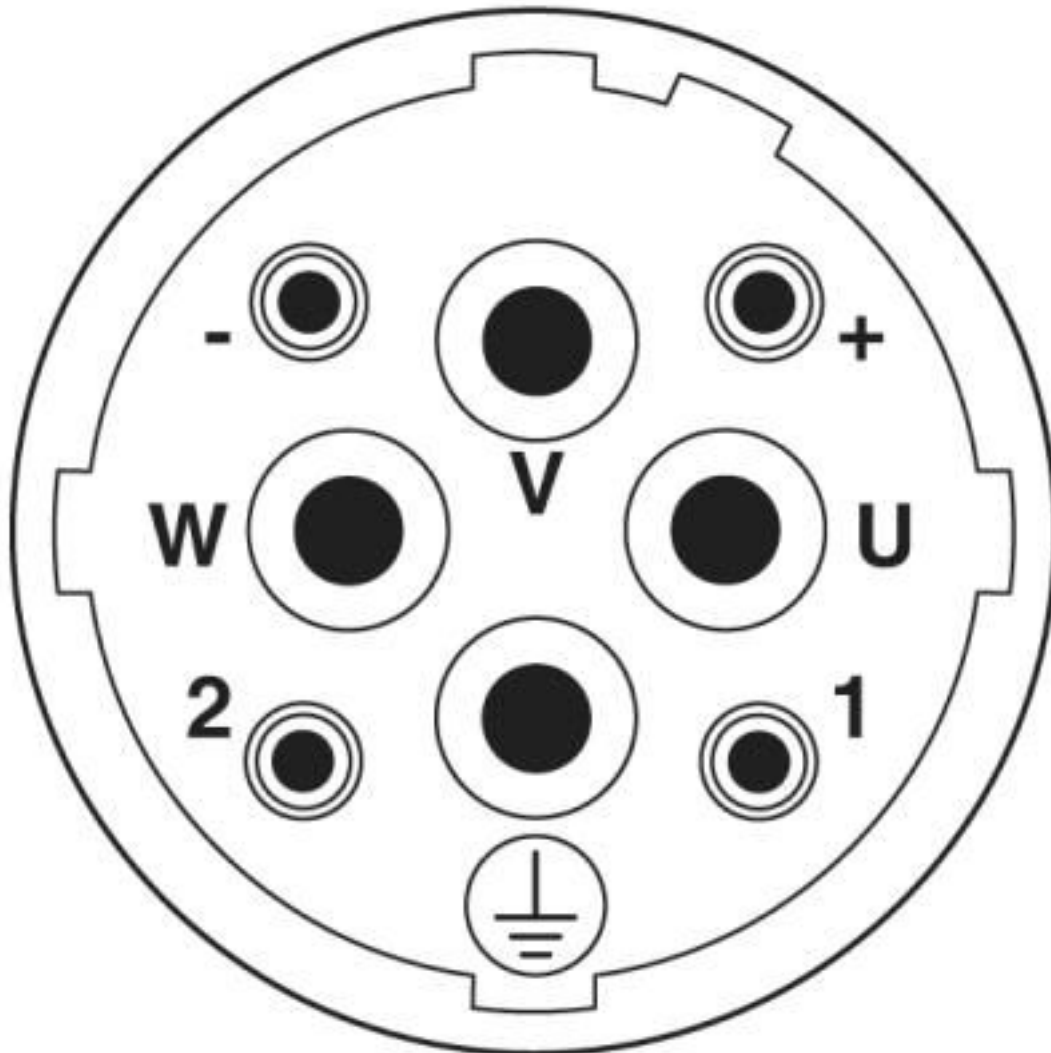

# Device connector, front mounting - SM-7EPWN8AA200 - 1613526

Diagram

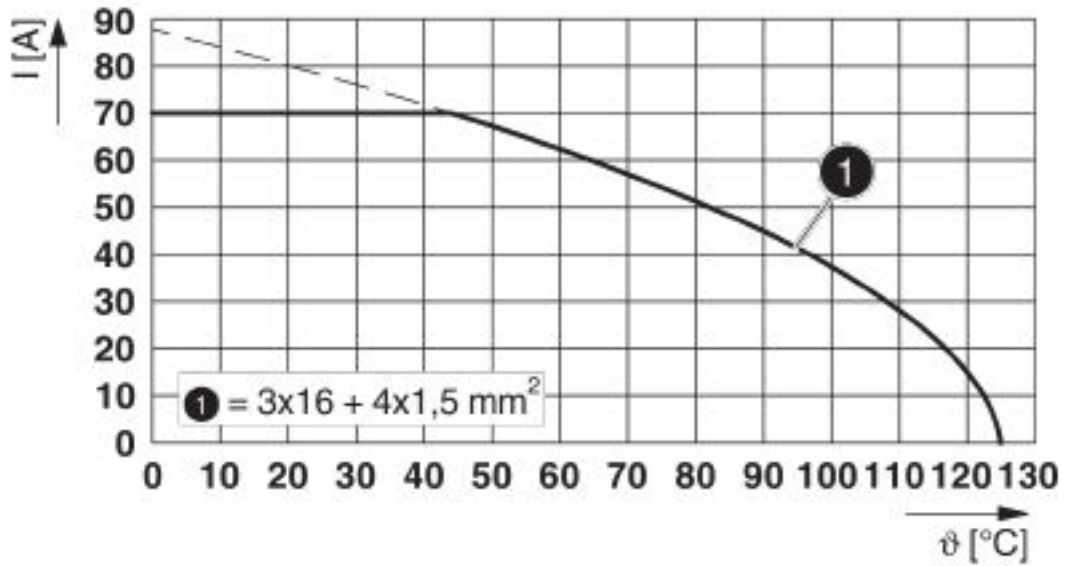

I = current strength, T = ambient temperature

# Device connector, front mounting - SM-7EPWN8AA200 - 1613526

Dimensional drawing

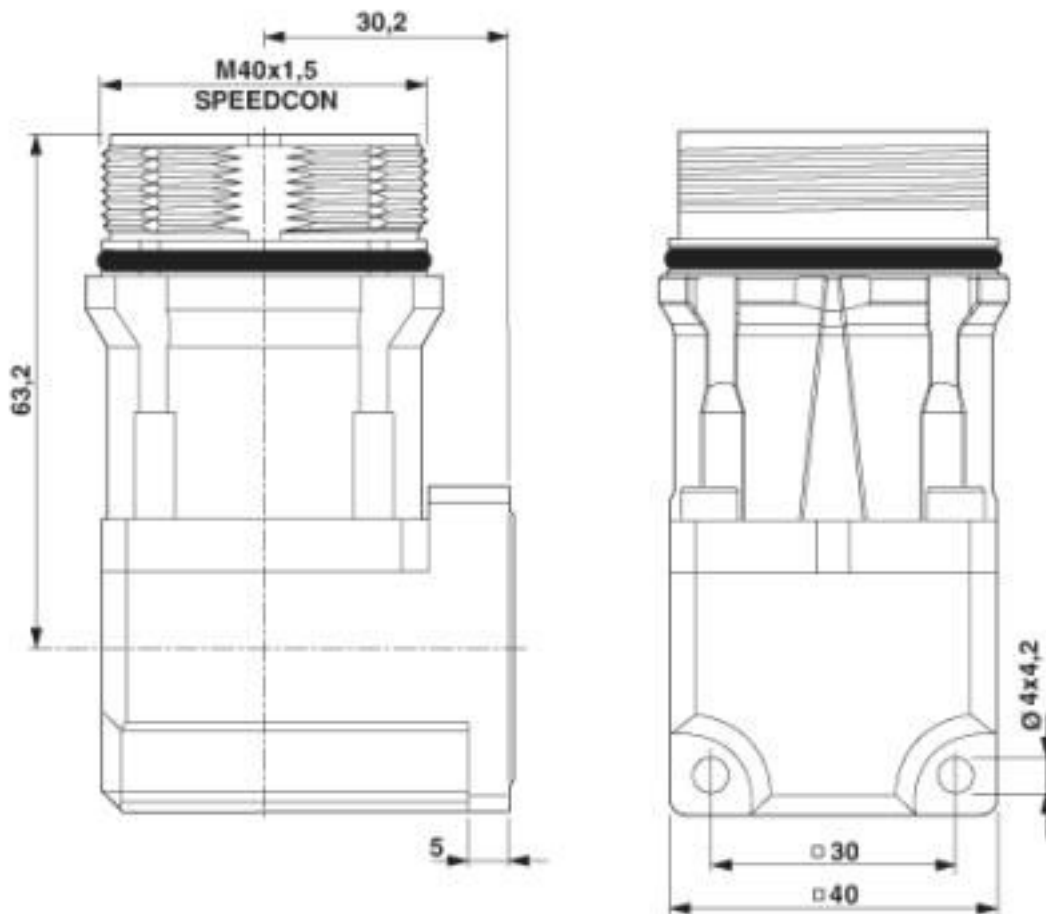

## Classifications

eCl@ss

eCl@ss 10.0.1	27440102
eCl@ss 4.0	27140800
eCl@ss 4.1	27140800
eCl@ss 5.0	27143400
eCl@ss 5.1	27143400
eCl@ss 6.0	27279200
eCl@ss 7.0	27440103
eCl@ss 8.0	27440103
eCl@ss 9.0	27440102

ETIM

ETIM 3.0	EC001121
ETIM 4.0	EC001121
ETIM 5.0	EC002061

# Device connector, front mounting - SM-7EPWN8AA200 - 1613526

## Classifications

### ETIM

ETIM 6.0	EC002061
----------	----------

### UNSPSC

UNSPSC 6.01	43172015
UNSPSC 7.0901	43201404
UNSPSC 11	43172015
UNSPSC 12.01	43201404
UNSPSC 13.2	39121413
UNSPSC 18.0	39121413
UNSPSC 19.0	39121413
UNSPSC 20.0	39121413
UNSPSC 21.0	39121413

## Approvals

### Approvals

#### Approvals

UL Recognized / cUL Recognized / EAC / cULus Recognized

#### Ex Approvals

### Approval details

UL Recognized		<a href="http://database.ul.com/cgi-bin/XYV/template/LISEXT/1FRAME/index.htm">http://database.ul.com/cgi-bin/XYV/template/LISEXT/1FRAME/index.htm</a>	FILE E 153698
Nominal voltage UN	600 V		
Nominal current IN	65 A		

cUL Recognized		<a href="http://database.ul.com/cgi-bin/XYV/template/LISEXT/1FRAME/index.htm">http://database.ul.com/cgi-bin/XYV/template/LISEXT/1FRAME/index.htm</a>	FILE E 153698
Nominal voltage UN	600 V		
Nominal current IN	40 A		



## Device connector, front mounting - SM-7EPWN8AA200 - 1613526

### Approvals

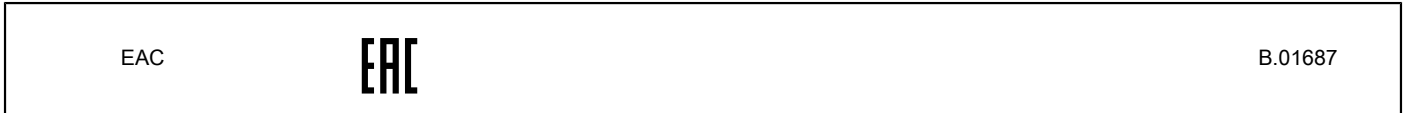

Phoenix Contact 2020 © - all rights reserved  
<http://www.phoenixcontact.com>

PHOENIX CONTACT GmbH & Co. KG  
Flachsmarktstr. 8  
32825 Blomberg  
Germany  
Tel. +49 5235 300  
Fax +49 5235 3 41200  
<http://www.phoenixcontact.com>

## X-ON Electronics

Largest Supplier of Electrical and Electronic Components

*Click to view similar products for [Circular Metric Connectors](#) category:*

*Click to view products by [Phoenix Contact](#) manufacturer:*

Other Similar products are found below :

[600X518037X](#) [6STD15PCR99B70A](#) [8R4000A16M020](#) [8R5000A16M005](#) [1200910002](#) [1203580030](#) [1200910008](#) [1200910011](#) [1300140094](#)  
[130203-0054](#) [1300140026](#) [1300150099](#) [RF-12S1N8A90DU](#) [1612618](#) [21036836414](#) [8R4006A16M010](#) [8R5006A18A120](#) [1604232](#)  
[1R3006A20M005](#) [RF-12P1N8A80DU](#) [RF-12P1N8A90DU](#) [41-40011](#) [42-00006](#) [42-01015](#) [4-22279-4](#) [4-22281-1](#) [4-22284-9](#) [43-00113](#) [43-](#)  
[01088](#) [43-01203](#) [41-40013](#) [42-00008](#) [43-00343](#) [43-01032](#) [43-01162](#) [43-01173](#) [43-10000](#) [XS3P-M421-2](#) [600X518050X](#) [SACC-DSI-FS-5P-](#)  
[PG9-L180 SC](#) [8R5006A16M020](#) [8R5006A16M005](#) [8R4000A16M010](#) [6-22279-3](#) [1605332](#) [N03FA03144](#) [1300140077](#) [43-16213](#) [43-01338](#)  
[XS2RD4265](#)