

Panel feed-through - Q 1,5/4FL/24-M20KU-ESA - 1641471

Please be informed that the data shown in this PDF Document is generated from our Online Catalog. Please find the complete data in the user's documentation. Our General Terms of Use for Downloads are valid (<http://phoenixcontact.com/download>)



Panel feed-through, for external wall mounting, with manual solder/slip-on connection, 4.8 x 0.8 mm

Your advantages

- ✓ Robust throughout: housing with IP65/IP67 protection for a wide range of applications



Key Commercial Data

Packing unit	10 pc
GTIN	
GTIN	4017918876562

Technical data

General

Connection	If the conductor is reconnected, it must be cut off above the last contact point. QUICKON components may only be operated when under no load.
Color	green
Connection method	QUICKON connection
	Manual solder/slip-on connection; 4.8 x 0.8 mm
Number of positions	4
Wrench size, union nut	19 mm
Tightening torque, union nut	3 Nm
Wrench size, contact carrier	24 mm
Tightening torque contact carrier	4.5 Nm
Tightening torque, counter nut	4.5 Nm
Number of connections	4
Conductor cross section flexible min.	0.75 mm ²
Conductor cross section flexible max.	1.5 mm ²
Conductor cross section solid min.	0.75 mm ²

Panel feed-through - Q 1,5/4FL/24-M20KU-ESA - 1641471

Technical data

General

Conductor cross section solid max.	1 mm ²
Conductor cross section AWG min.	18
Conductor cross section AWG max.	16

Cabel

Structure of individual litz in acc. with VDE 0295 / smallest wire diameter	VDE 0295 class 1 to 6/min. 0.15 mm
Wire insulation material	PVC / PE
Wire diameter including insulation	1.8 mm ... 3 mm
External cable diameter	6 mm ... 12 mm
Position marking	1, 2, 3, 4

Ambient conditions

Degree of protection	IP65
	IP67
Ambient temperature (operation)	-40 °C ... 80 °C (specifications of the cable manufacturer must also be observed)
	-25 °C ... 50 °C
Temperature when conductor connected	-5 °C ... 50 °C (specifications of the cable manufacturer must also be observed)

Electrical characteristics

Nominal current I _N	15 A
Nominal voltage U _N	500 V AC
	500 V DC
Rated current	15 A
Rated voltage (III/3)	500 V
Note on the rated voltage (III/3)	with insulating sleeve PT/FS 4,8. Without insulating sleeve 250 V AC.
Rated voltage (III/2)	800 V
Rated voltage (II/2)	1000 V
Rated surge voltage (III/3)	6 kV
Rated surge voltage (III/2)	6 kV
Rated surge voltage (II/2)	6 kV

Mechanical characteristics

QUICKON connectability	max. 10
PC QUICKON thread type	M20

Material data

Contact material	CuZn
Contact surface material	Tin-plated
Contact carrier material	PA
Insulating material	PA
Flammability rating according to UL 94	V0
Overvoltage category	III

Panel feed-through - Q 1,5/4FL/24-M20KU-ESA - 1641471

Technical data

Material data

Degree of pollution	3
---------------------	---

Standards and Regulations

Connection in acc. with standard	CUL
Flammability rating according to UL 94	V0

Environmental Product Compliance

China RoHS	Environmentally Friendly Use Period = 50 years
	For details about hazardous substances go to tab "Downloads", Category "Manufacturer's declaration"

Drawings

Diagram

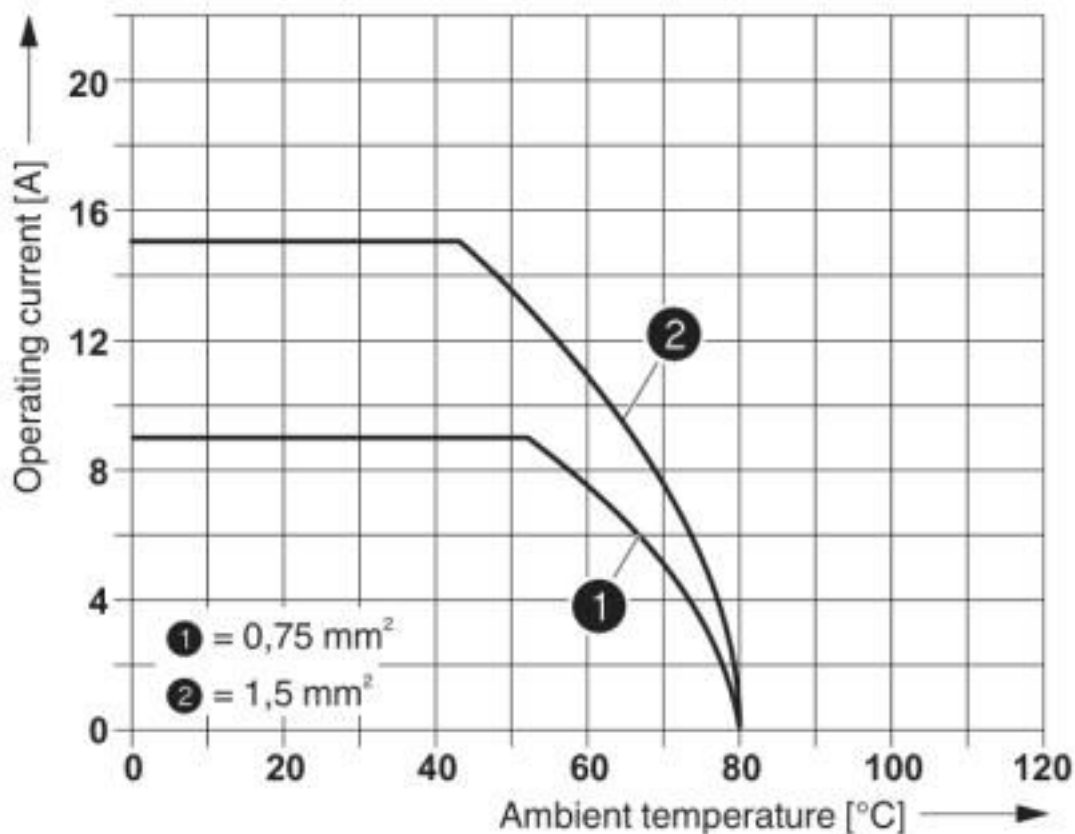

Panel feed-through - Q 1,5/4FL/24-M20KU-ESA - 1641471

Dimensional drawing

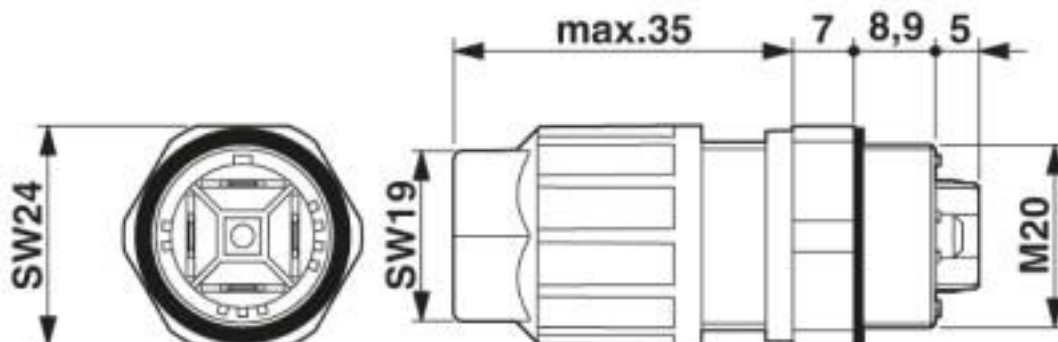

Classifications

eCl@ss

eCl@ss 10.0.1	27440602
eCl@ss 4.0	27140800
eCl@ss 4.1	27140800
eCl@ss 5.0	27143400
eCl@ss 5.1	27143400
eCl@ss 6.0	27143400
eCl@ss 7.0	27440602
eCl@ss 8.0	27440602
eCl@ss 9.0	27440602

ETIM

ETIM 2.0	EC001297
ETIM 3.0	EC000516
ETIM 4.0	EC000516
ETIM 5.0	EC002566
ETIM 6.0	EC002566
ETIM 7.0	EC002566

UNSPSC

UNSPSC 6.01	30211923
UNSPSC 7.0901	39121522
UNSPSC 11	39121522
UNSPSC 12.01	39121522
UNSPSC 13.2	39121413
UNSPSC 18.0	39121522
UNSPSC 19.0	39121522
UNSPSC 20.0	39121522
UNSPSC 21.0	39121522

Panel feed-through - Q 1,5/4FL/24-M20KU-ESA - 1641471

Approvals

Approvals

Approvals

UL Recognized / cUL Recognized / VDE Zeichengenehmigung / EAC / EAC / EAC / cULus Recognized

Ex Approvals

Approval details

UL Recognized		http://database.ul.com/cgi-bin/XYV/template/LISEXT/1FRAME/index.htm	FILE E 118976
Nominal voltage UN		250 V	
Nominal current IN		15 A	

cUL Recognized		http://database.ul.com/cgi-bin/XYV/template/LISEXT/1FRAME/index.htm	FILE E 118976
Nominal voltage UN		250 V	
Nominal current IN		11 A	

VDE Zeichengenehmigung		http://www2.vde.com/de/Institut/Online-Service/VDE-gepruefteProdukte/Seiten/Online-Suche.aspx	40032336
Nominal voltage UN		500 V	
mm ² /AWG/kcmil		0.75-1.5	

EAC		EAC-Zulassung
-----	---	---------------

EAC		RU C- DE.A*30.B.01102
-----	---	--------------------------

Panel feed-through - Q 1,5/4FL/24-M20KU-ESA - 1641471

Approvals

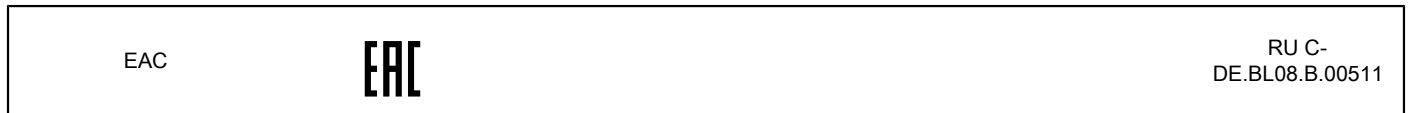

Accessories

Accessories

Electronics pliers

Diagonal cutter - MICROFOX-SB - 1212489



Electronic diagonal cutter, round head, without chamfer, with opening spring, mirror-polished and oiled, 2-component grip, cutting capacity: soft 0.2 - 2.0 mm; medium hard 1.2 mm; hard 0.5 mm diameter

Insulating sleeve

Insulating sleeve - PT/FS 4,8 - 1670497



Insulating sleeve, as touch protection, for 4.8 mm slip-on sleeves, slide onto the conductor before

Mounting material

Nut - Q-MU M20 - 1640702



Nut (plastic) to lock the contact carrier from the inside of the device

Sealing plugs

Panel feed-through - Q 1,5/4FL/24-M20KU-ESA - 1641471

Accessories

Filler plugs - Q-PROT13/16 - 1670222



Closing caps, for Pg13/ Pg16, for closing unoccupied connections

Socket spanner

Socket wrench - QSS 19 - 1670895



Socket wrench, for tightening and unscrewing the QUICKON union nut, wrench size 19 mm

Phoenix Contact 2020 © - all rights reserved
<http://www.phoenixcontact.com>

PHOENIX CONTACT GmbH & Co. KG
Flachsmarktstr. 8
32825 Blomberg
Germany
Tel. +49 5235 300
Fax +49 5235 3 41200
<http://www.phoenixcontact.com>

X-ON Electronics

Largest Supplier of Electrical and Electronic Components

Click to view similar products for [Circular Metric Connectors](#) category:

Click to view products by [Phoenix Contact](#) manufacturer:

Other Similar products are found below :

[600X518037X](#) [MA1EAF1200](#) [6STD15PCR99B70A](#) [8R4000A16M020](#) [8R4A00A18M020](#) [8R5000A16M005](#) [1200910008](#) [1200910011](#)
[1300140094](#) [130203-0054](#) [1300150099](#) [RF-12S1N8A90DU](#) [1-3637-600-5205](#) [1612618](#) [8R4006A16M010](#) [8R5006A18A120](#) [1604232](#)
[1R3006A20M005](#) [RF-12P1N8A80DU](#) [RF-12P1N8A90DU](#) [41-01016](#) [41-40011](#) [41-40017](#) [42-01015](#) [4-22279-4](#) [4-22281-1](#) [4-22284-9](#) [43-](#)
[00002](#) [43-01166](#) [41-40005](#) [41-40016](#) [43-00161](#) [43-01191](#) [XS3P-M421-2](#) [600X518050X](#) [SACC-DSI-FS-5P-PG9-L180 SC](#) [8R4006A16A120](#)
[8R4000A16M010](#) [RKC 50/16](#) [1R3004A20A1201](#) [6-22279-3](#) [N03FA03144](#) [1300140077](#) [XS8A-0441](#) [859RD04-103R004](#) [860RD04-113R004](#)
[860RD04-213R004](#) [860-X08-213R004](#) [1-213245-2](#) [2273142-2](#)