

Contact insert - HC-B 16-I-UT-F - 1648241

Please be informed that the data shown in this PDF Document is generated from our Online Catalog. Please find the complete data in the user's documentation. Our General Terms of Use for Downloads are valid (<http://phoenixcontact.com/download>)



HEAVYCON female insert, B16 series, 16-pos., screw connection

Your advantages

- For fast coding with plastic profile
- For test pin 2 mm



Key Commercial Data

Packing unit	1 pc
GTIN	 4 046356 092371
GTIN	4046356092371

Technical data

General

Note	for flexible conductors with or without ferrules
	Connectors may be operated only when there is no load/voltage.
Connection method	Screw connection
Tightening torque	0.5 Nm ... 0.8 Nm
Torque	0.8 Nm ... 1.2 Nm (PE connection)
	0.5 Nm ... 0.8 Nm (Mounting screws for mounting in the HEAVYCON housing)
Screwdriver blade	0.5 x 3.5 mm
Number of connections per position	1
Degree of pollution	3
Overvoltage category	III
Number of positions	16+PE
Insertion/withdrawal cycles	≥ 500
Size	B16

Contact insert - HC-B 16-I-UT-F - 1648241

Technical data

General

	B32
Contact numbering	1 - 16
Conductor cross section	0.5 mm ² ... 2.5 mm ²
Connection cross section AWG	20 ... 14
Stripping length of the individual wire	8 mm
Assembly instructions	To ensure correct use, installation in housing with IP54 protection or better is required

Ambient conditions

Ambient temperature (operation)	-40 °C ... 125 °C (including heating up of contacts)
---------------------------------	--

Material data

Contact material	Copper alloy
Contact surface material	Ag
Contact carrier material	PC
Standards/regulations	PC: Fire protection in rail vehicles - requirement sets R22 and R23 acc. to DIN EN 45545-2 (Risk level HL1 - HL2)

Electrical characteristics

Rated voltage (III/3)	500 V
Rated surge voltage	6 kV
Rated current	20 A

Standards and Regulations

Connection in acc. with standard	CSA
Constructional and testing regulations	DIN EN 61984
	DIN EN 60664
	IEC 60352
Flammability rating according to UL 94	V0
Standards/regulations	acc. to DIN EN 45545-2

Environmental Product Compliance

REACH SVHC	Lead 7439-92-1
China RoHS	Environmentally friendly use period: unlimited = EFUP-e
	No hazardous substances above threshold values

Drawings

Contact insert - HC-B 16-I-UT-F - 1648241

Schematic diagram

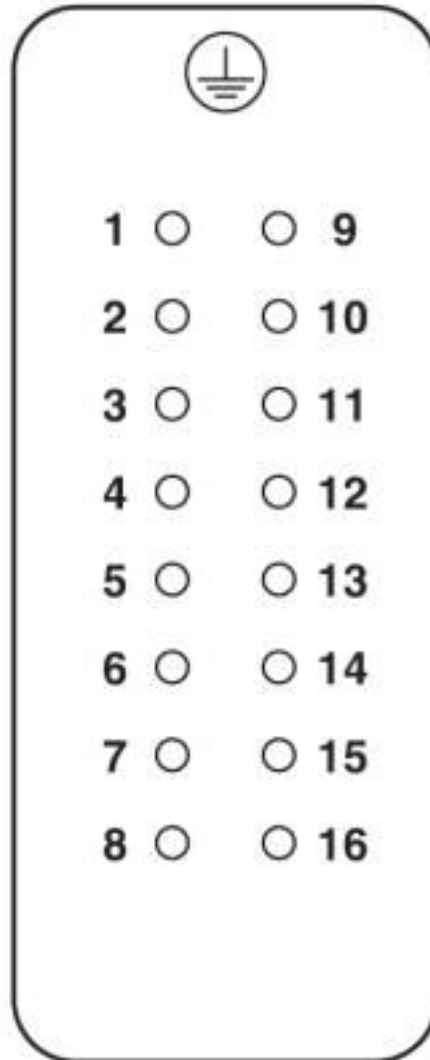

Connector pin assignment, connection side

Contact insert - HC-B 16-I-UT-F - 1648241

Diagram

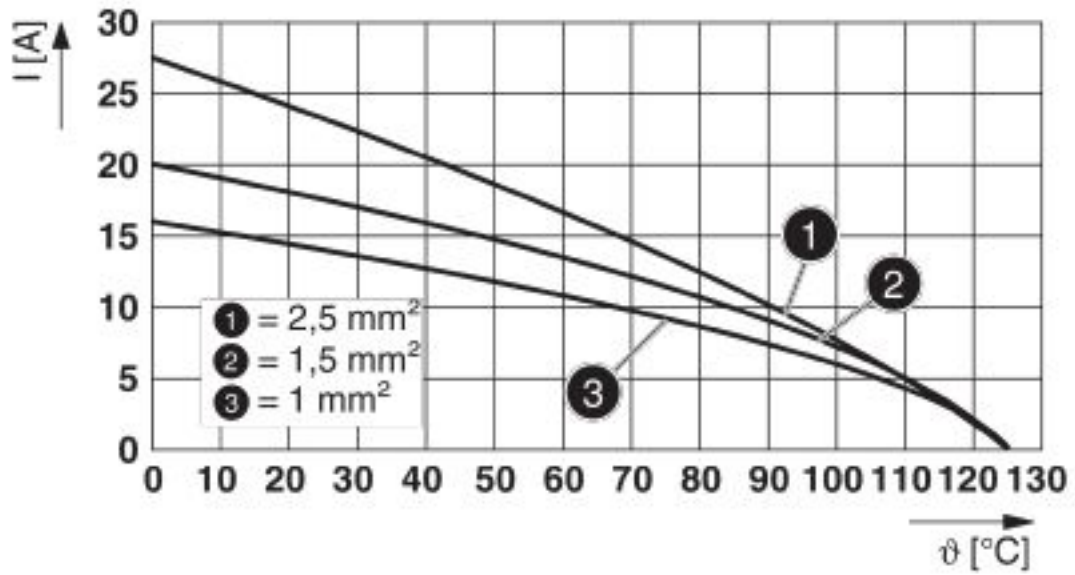

Derating diagram

Dimensional drawing

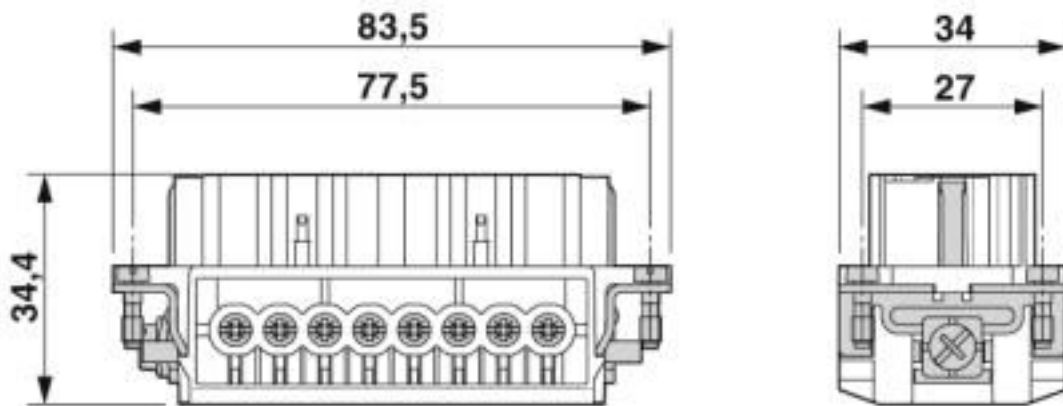

Female insert

Contact insert - HC-B 16-I-UT-F - 1648241

Dimensional drawing

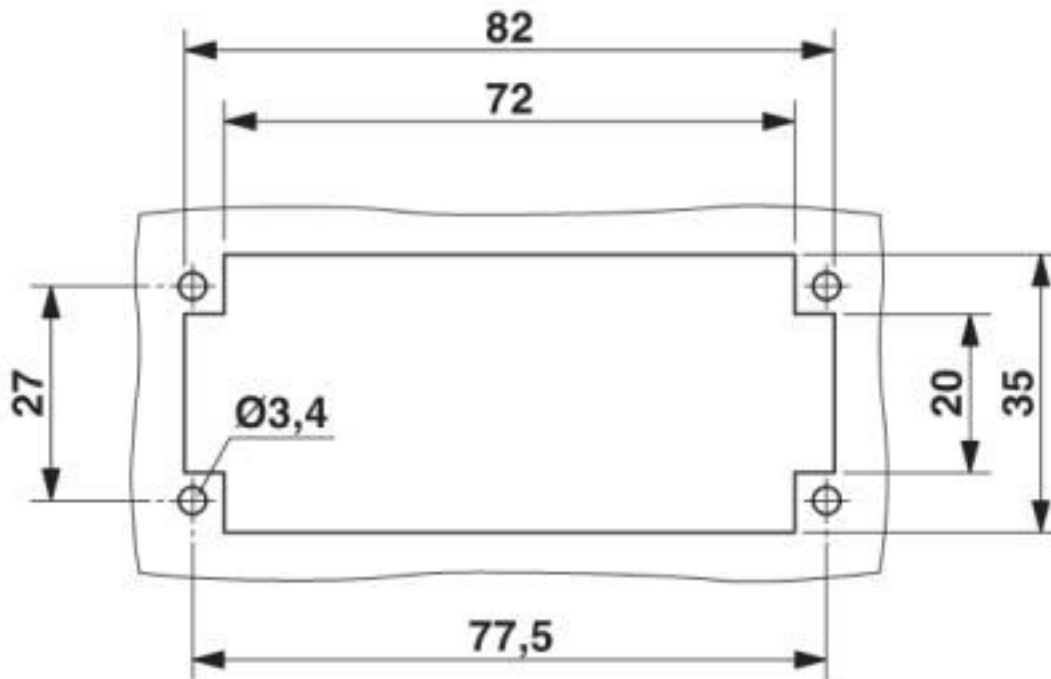

Mounting cutout when used without housing

Classifications

eCl@ss

eCl@ss 10.0.1	27440205
eCl@ss 4.0	27140800
eCl@ss 4.1	27140800
eCl@ss 5.0	27143400
eCl@ss 5.1	27261200
eCl@ss 6.0	27261200
eCl@ss 7.0	27440205
eCl@ss 8.0	27440205
eCl@ss 9.0	27440205

ETIM

ETIM 3.0	EC000438
ETIM 4.0	EC000438
ETIM 5.0	EC000438
ETIM 6.0	EC000438
ETIM 7.0	EC000438

UNSPSC

UNSPSC 6.01	30211923
-------------	----------

Contact insert - HC-B 16-I-UT-F - 1648241

Classifications

UNSPSC

UNSPSC 7.0901	39121522
UNSPSC 11	39121522
UNSPSC 12.01	39121522
UNSPSC 13.2	39121522
UNSPSC 18.0	39121522
UNSPSC 19.0	39121522
UNSPSC 20.0	39121522
UNSPSC 21.0	39121522

Approvals

Approvals

Approvals

CSA / EAC / EAC / UL Recognized / DNV GL

Ex Approvals

Approval details

CSA		http://www.csagroup.org/services-industries/product-listing/	013631_6233_01
Nominal voltage UN		600 V	
Nominal current IN		13 A	
mm ² /AWG/kcmil		22-14	

EAC		RU C- DE.AI30.B.01102
-----	---	--------------------------

EAC		RU C- DE.BL08.B.00511
-----	---	--------------------------

Contact insert - HC-B 16-I-UT-F - 1648241

Approvals

UL Recognized		http://database.ul.com/cgi-bin/XYV/template/LISEXT/1FRAME/index.htm	FILE E 118976
Nominal voltage UN		600 V	
Nominal current IN		16 A	
mm ² /AWG/kcmil		14	

DNV GL		https://approvalfinder.dnvgl.com/	TAE000037S
--------	--	---	------------

Accessories

Accessories

Coding element

Coding profile - CP-HC - 1686478



Coding profile, 4 coding profiles per strip, for insertion in coding keyways

Coding element - HC-CBU - 1676860



Coding socket for coding up to 16 connectors

Coding bolt - HC-CB - 1772722



Coding pin, prevents mismatching of up to six connectors with an identical number of positions

Contact insert - HC-B 16-I-UT-F - 1648241

Accessories

Coding element - HC-CST - 1676857



Coding peg for coding up to 16 connectors

Docking frame

Docking frames - HC-B 16-ANDOCK - 1586138



Docking frame for racks, for contact inserts of B16 type, with four M5 flat headed screws, rack balance x/y axis +/- 1.5 mm

Mounting material

Screw - HC-B-PES - 1604997



PE screw, for contact inserts HC-B / HC-BB / HC-DD / HC-D40 / HC-D64

PE multiplier - HC-B-3PE - 1644326



PE multiplier, for three PE connections, for HC-B (besides HC-B..E..ZZ) / HC-BB / HC-DD / HC-D40 / HC-D64 contact inserts

Strain relief clamp - HC-B-ZG - 1685327



Strain relief clamps contact inserts of series: B-, BB-, D 40, D 64, DD and HV, straight cable exit

Contact insert - HC-B 16-I-UT-F - 1648241

Accessories

Strain relief clamp - HC-B-ZS - 1685330



Strain relief clamps contact inserts of series: B-, BB-, D 40, D 64, DD and HV, lateral cable exit

Additional products

Contact insert - HC-B 16-I-UT-M - 1648238



HEAVYCON male insert, B16 series, 16-pos., screw connection

Phoenix Contact 2020 © - all rights reserved
<http://www.phoenixcontact.com>

PHOENIX CONTACT GmbH & Co. KG
Flachsmarktstr. 8
32825 Blomberg
Germany
Tel. +49 5235 300
Fax +49 5235 3 41200
<http://www.phoenixcontact.com>

X-ON Electronics

Largest Supplier of Electrical and Electronic Components

Click to view similar products for [Heavy Duty Power Connectors](#) category:

Click to view products by [Phoenix Contact](#) manufacturer:

Other Similar products are found below :

[647757-1](#) [6643411-1](#) [6646058-2](#) [6646137-1](#) [6646138-1](#) [6646479-1](#) [6646608-1](#) [6646786-1](#) [6646940-1](#) [6651091-1](#) [6651525-1](#) [6651529-1](#)
[6651788-1](#) [696475-1](#) [702-32-01109](#) [703-25-02205](#) [73000005059](#) [73000005642](#) [73080255059](#) [73080965046](#) [765-15-0080A](#) [765-16-0080B](#)
[765-18-0080D](#) [829992-1](#) [902-77-02113](#) [PS00/A0620/6300](#) [PS25/A0420/63](#) [129-1J](#) [1409400](#) [AN0024023](#) [E6374G1](#) [e6389g2](#) [157-43GW8](#)
[MS3117-14AC](#) [1643543-1](#) [1650540-1](#) [1651811-2](#) [1766260-1](#) [1766282-1](#) [1766966-1](#) [1791340000](#) [NLDFT-3-BL-L-S120-M40A](#) [NLDFT-N-](#)
[W-L-C240-M40B](#) [NLS-2-R-C240-M40B](#) [NLS-N-W-C240-M40B](#) [NPS-3-BL-T6](#) [1986615-1](#) [2-1589900-8](#) [2199314-1](#) [KA8102](#)