

Contact insert - HC-B 16-I-CT-F - 1648283

Please be informed that the data shown in this PDF Document is generated from our Online Catalog. Please find the complete data in the user's documentation. Our General Terms of Use for Downloads are valid (<http://phoenixcontact.com/download>)



HEAVYCON female insert, B16 series, 16-pos., for crimp contacts

Your advantages

- For fast coding with plastic profile



Key Commercial Data

Packing unit	1 pc
GTIN	 4 046356 092418
GTIN	4046356092418

Technical data

General

Note	For HEAVYCON ADVANCE and HEAVYCON housing of B16 type, crimp contacts CK 2,5-ED (crimp contacts not included in the scope of supply).
	Connectors may be operated only when there is no load/voltage.
Connection method	Crimp connection
Torque	0.8 Nm ... 1.2 Nm (PE connection)
	0.5 Nm ... 0.8 Nm (Mounting screws for mounting in the HEAVYCON housing)
Number of connections per position	1
Degree of pollution	3
Overvoltage category	III
Number of positions	16+PE
Insertion/withdrawal cycles	≥ 500
Size	B16
	B32
Contact numbering	1 - 16

Contact insert - HC-B 16-I-CT-F - 1648283

Technical data

General

Conductor cross section	0.5 mm ² ... 4 mm ²
Connection cross section AWG	20 ... 12
Stripping length of the individual wire	7.5 mm
Assembly instructions	To ensure correct use, installation in housing with IP54 protection or better is required
Connection	Remove the crimp contact using a screwdriver. The opening for the screwdriver is next to the opening where the conductor is inserted.

Ambient conditions

Degree of protection (IP)	IP20
Ambient temperature (operation)	-40 °C ... 125 °C (including heating up of contacts)

Material data

Contact material	Copper alloy
Contact surface material	Ag (alternatively Au)
Contact carrier material	PA
Standards/regulations	PA: Fire protection in rail vehicles - requirement sets R22 and R23 acc. to DIN EN 45545-2 (Risk level HL1 - HL2)
	PA: Fire protection in rail vehicles - requirement set R24 acc. to DIN EN 45545-2 (Risk level HL1 - HL3)

Electrical characteristics

Rated voltage (III/3)	500 V
Rated surge voltage	6 kV
Rated current	16 A

Standards and Regulations

Connection in acc. with standard	CSA
Constructional and testing regulations	DIN EN 61984
	DIN EN 60664
	IEC 60352
Flammability rating according to UL 94	V0
Standards/regulations	acc. to DIN EN 45545-2

Environmental Product Compliance

China RoHS	Environmentally friendly use period: unlimited = EFUP-e
	No hazardous substances above threshold values

Drawings

Contact insert - HC-B 16-I-CT-F - 1648283

Schematic diagram

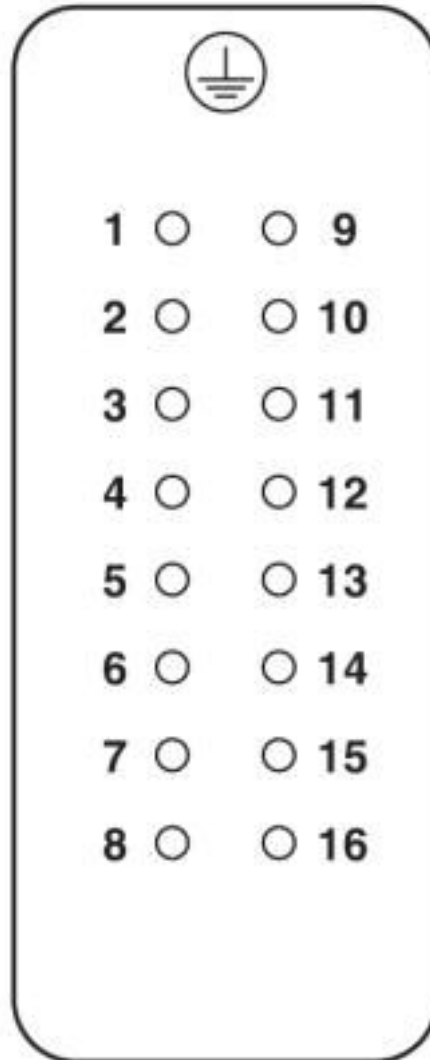

Connector pin assignment, connection side

Contact insert - HC-B 16-I-CT-F - 1648283

Diagram

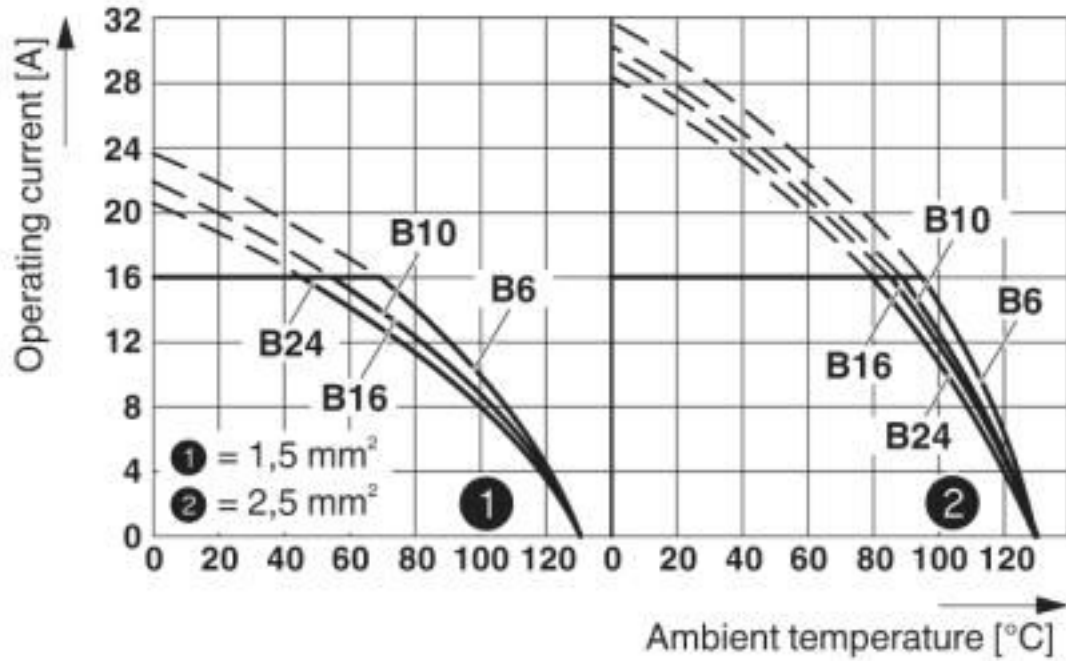

Derating diagram

Dimensional drawing

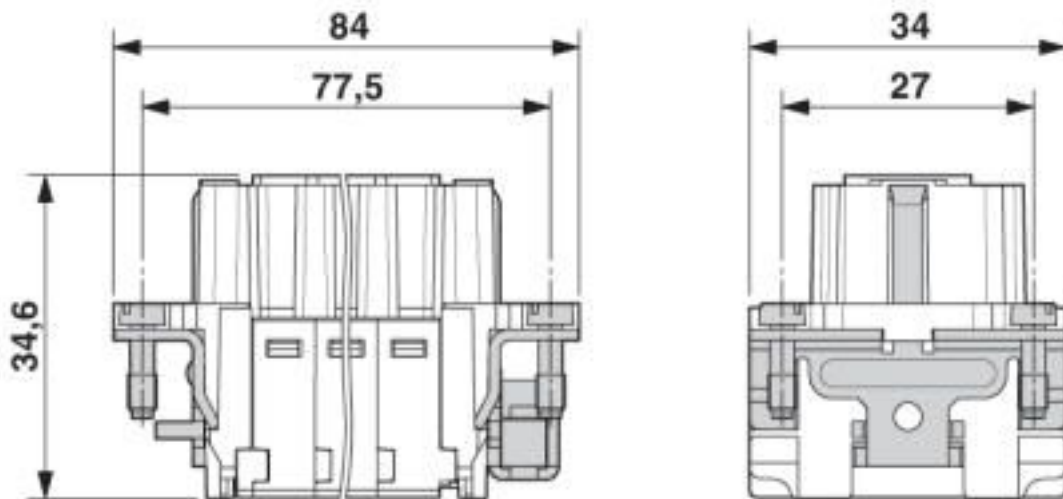

Female insert

Contact insert - HC-B 16-I-CT-F - 1648283

Dimensional drawing

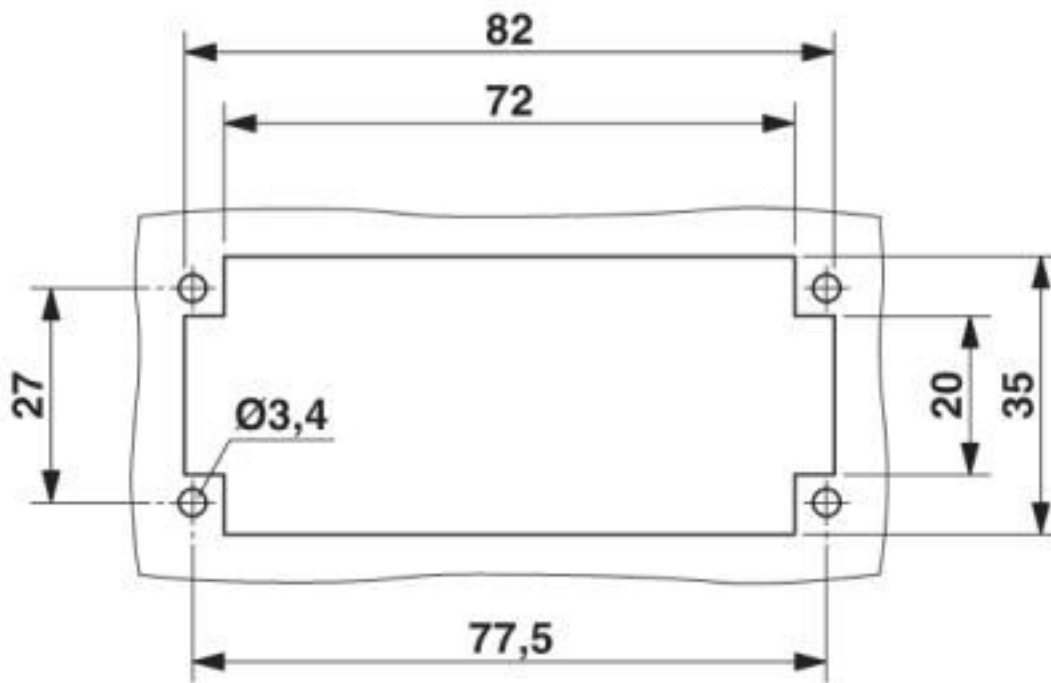

Mounting cutout when used without housing

Classifications

eCl@ss

eCl@ss 10.0.1	27440205
eCl@ss 4.0	27140800
eCl@ss 4.1	27140800
eCl@ss 5.0	27143400
eCl@ss 5.1	27261200
eCl@ss 6.0	27261200
eCl@ss 7.0	27440205
eCl@ss 8.0	27440205
eCl@ss 9.0	27440205

ETIM

ETIM 2.0	EC000438
ETIM 3.0	EC000438
ETIM 4.0	EC000438
ETIM 5.0	EC000438
ETIM 6.0	EC000438
ETIM 7.0	EC000438

Contact insert - HC-B 16-I-CT-F - 1648283

Classifications

UNSPSC

UNSPSC 6.01	30211923
UNSPSC 7.0901	39121522
UNSPSC 11	39121522
UNSPSC 12.01	39121522
UNSPSC 13.2	39121522
UNSPSC 18.0	39121522
UNSPSC 19.0	39121522
UNSPSC 20.0	39121522
UNSPSC 21.0	39121522

Approvals

Approvals

Approvals

CSA / UL Recognized / cUL Recognized / EAC / DNV GL / EAC / cULus Recognized

Ex Approvals

Approval details

CSA		http://www.csagroup.org/services-industries/product-listing/	013631_6233_01
Nominal voltage UN	600 V		
Nominal current IN	20 A		
mm ² /AWG/kcmil	20-12		

UL Recognized		http://database.ul.com/cgi-bin/XYV/template/LISEXT/1FRAME/index.htm	FILE E 118976
Nominal voltage UN	600 V		
Nominal current IN	13 A		
mm ² /AWG/kcmil	22-14		

Contact insert - HC-B 16-I-CT-F - 1648283

Approvals

cUL Recognized		http://database.ul.com/cgi-bin/XYV/template/LISEXT/1FRAME/index.htm	FILE E 118976
Nominal voltage UN	600 V		
Nominal current IN	13 A		
mm ² /AWG/kcmil	22-14		

EAC		RU C- DE.AI30.B.01102
-----	--	--------------------------

DNV GL		https://approvalfinder.dnvgl.com/	TAE000037S
--------	--	---	------------

EAC		RU C- DE.BL08.B.00511
-----	--	--------------------------

cULus Recognized			
------------------	--	--	--

Accessories

Accessories

Assembly tool

Assembly tool - UNIFOX MT-CK 1.6/2.5 - 1089092



Assembly tool, for CK 1.6... crimp contacts for small conductor cross sections

Coding element

Contact insert - HC-B 16-I-CT-F - 1648283

Accessories

Coding profile - CP-HC - 1686478



Coding profile, 4 coding profiles per strip, for insertion in coding keyways

Coding element - HC-CBU - 1676860



Coding socket for coding up to 16 connectors

Coding bolt - HC-CB - 1772722



Coding pin, prevents mismatching of up to six connectors with an identical number of positions

Coding element - HC-CST - 1676857



Coding peg for coding up to 16 connectors

Dummy socket - CK2,5-ED-BB - 1584693



Dummy socket for contact carrier with turned CK 2,5-ED... socket contacts. For HC-A../HC-BB../HC-M... series contact inserts.

Crimp contact

Contact insert - HC-B 16-I-CT-F - 1648283

Accessories

Crimp contact - CK2,5-ED-0,50BU AG - 1663640



Turned 2.5 crimp contact, individual female contact, core diameter 0.5 mm², silver-plated

Crimp contact - CK2,5-ED-0,75BU AG - 1663653



Turned 2.5 crimp contact, individual female contact, core diameter 0.75 mm², silver-plated

Crimp contact - CK2,5-ED-1,00BU AG - 1663666



Turned 2.5 crimp contact, individual female contact, core diameter 0.75 to 1.00 mm², silver-plated

Crimp contact - CK2,5-ED-1,50BU AG - 1663679



Turned 2.5 crimp contact, individual female contact, core diameter 1.5 mm², silver-plated

Crimp contact - CK2,5-ED-2,50BU AG - 1663682



Turned 2.5 crimp contact, individual female contact, core diameter 2.5 mm², silver-plated

Contact insert - HC-B 16-I-CT-F - 1648283

Accessories

Crimp contact - CK2,5-ED-3,00BU AG - 1663695



Turned 2.5 crimp contact, individual female contact, core diameter 3.00 mm², silver-plated

Crimp contact - CK2,5-ED-4,00BU AG - 1663705



Turned 2.5 crimp contact, individual female contact, core diameter 4.00 mm², silver-plated

Crimp contact - CK2,5-ED-0,50BU AU - 1674859



Turned 2.5 crimp contact, individual female contact, core diameter 0.5 mm², gold-plated

Crimp contact - CK2,5-ED-1,00BU AU - 1674833



Turned 2.5 crimp contact, individual female contact, core diameter 0.75 to 1.0 mm², gold-plated

Crimp contact - CK2,5-ED-1,50BU AU - 1674820



Turned 2.5 crimp contact, individual female contact, core diameter 1.5 mm², gold-plated

Contact insert - HC-B 16-I-CT-F - 1648283

Accessories

Crimp contact - CK2,5-ED-2,50BU AU - 1674862



Turned 2.5 crimp contact, individual female contact, core diameter 2.5 mm², gold-plated

Crimp contact - CK2,5-ED-4,00BU AU - 1674846



Turned 2.5 crimp contact, individual female contact, core diameter 4.00 mm², gold-plated

Crimping tool

Crimping pliers - CRIMPFOX-1,6/2,5-ED-4,0 - 1687419



Crimping pliers, for turned contacts, CK 1.6 ED... and CK 2.5 ED...

Docking frame

Docking frames - HC-B 16-ANDOCK - 1586138



Docking frame for racks, for contact inserts of B16 type, with four M5 flat headed screws, rack balance x/y axis +/- 1.5 mm

Mounting material

Screw - HC-B-PES - 1604997



PE screw, for contact inserts HC-B / HC-BB / HC-DD / HC-D40 / HC-D64

Contact insert - HC-B 16-I-CT-F - 1648283

Accessories

PE multiplier - HC-B-3PE - 1644326



PE multiplier, for three PE connections, for HC-B (besides HC-B..E..ZZ) / HC-BB / HC-DD / HC-D40 / HC-D64 contact inserts

Strain relief clamp - HC-B-ZG - 1685327



Strain relief clamps contact inserts of series: B-, BB-, D 40, D 64, DD and HV, straight cable exit

Strain relief clamp - HC-B-ZS - 1685330



Strain relief clamps contact inserts of series: B-, BB-, D 40, D 64, DD and HV, lateral cable exit

Crimp contact - CK2,5-ED-0,37BU AU - 1585647



Crimp contact, connection method: Crimp connection, connection cross section: AWG 22- 26

Additional products

Contact insert - HC-B 16-I-CT-M - 1648270



HEAVYCON male insert, B16 series, 16-pos., for crimp contacts

Phoenix Contact 2020 © - all rights reserved
<http://www.phoenixcontact.com>

PHOENIX CONTACT GmbH & Co. KG
Flachsmarktstr. 8
32825 Blomberg
Germany
Tel. +49 5235 300
Fax +49 5235 3 41200
<http://www.phoenixcontact.com>

X-ON Electronics

Largest Supplier of Electrical and Electronic Components

Click to view similar products for [Heavy Duty Power Connectors](#) category:

Click to view products by [Phoenix Contact](#) manufacturer:

Other Similar products are found below :

[647757-1](#) [6643411-1](#) [6646058-2](#) [6646137-1](#) [6646138-1](#) [6646479-1](#) [6646608-1](#) [6646786-1](#) [6646940-1](#) [6651091-1](#) [6651525-1](#) [6651529-1](#)
[6651788-1](#) [696475-1](#) [702-32-01109](#) [703-25-02205](#) [73000005059](#) [73000005642](#) [73080255059](#) [73080965046](#) [765-15-0080A](#) [765-16-0080B](#)
[765-18-0080D](#) [829992-1](#) [902-77-02113](#) [PS00/A0620/6300](#) [PS25/A0420/63](#) [129-1J](#) [1409400](#) [AN0024023](#) [E6374G1](#) [e6389g2](#) [157-43GW8](#)
[MS3117-14AC](#) [1643543-1](#) [1650540-1](#) [1651811-2](#) [1766260-1](#) [1766282-1](#) [1766966-1](#) [1791340000](#) [NLDFT-3-BL-L-S120-M40A](#) [NLDFT-N-](#)
[W-L-C240-M40B](#) [NLS-2-R-C240-M40B](#) [NLS-N-W-C240-M40B](#) [NPS-3-BL-T6](#) [1986615-1](#) [2-1589900-8](#) [2199314-1](#) [KA8102](#)