

# Terminal adapter - HC-B 16-A-DT-PER-M - 1648461

Please be informed that the data shown in this PDF Document is generated from our Online Catalog. Please find the complete data in the user's documentation. Our General Terms of Use for Downloads are valid (<http://phoenixcontact.com/download>)



HEAVYCON terminal adapter, pin insert, B16 series, 16-pos., for the right side of the control cabinet, push-in connection



COMPLETE RoHS

## Key Commercial Data

Packing unit	5 pc
GTIN	 4 046356 092180
GTIN	4046356092180

## Technical data

### Dimensions

Drill hole distance, horizontal	77.5 mm
Height	70.5 mm

### Ambient conditions

Degree of protection (IP)	IP20
Ambient temperature (operation)	-40 °C ... 125 °C

### Electrical characteristics

Number of positions	16
Rated voltage (III/3)	500 V
Rated surge voltage	6 kV
Rated current	16 A

### Mechanical characteristics

Type	B16
Connection method	Push-in connection
Stripping length of the individual wire	10 mm (13 mm if ferrules are used)
Conductor cross section	0.5 mm <sup>2</sup> ... 2.5 mm <sup>2</sup>
Connection cross section AWG	22 ... 12

# Terminal adapter - HC-B 16-A-DT-PER-M - 1648461

## Technical data

### General

Note	For HEAVYCON-ADVANCE mounting flange and HEAVYCON panel mounting base of B16 type
	Connectors may be operated only when there is no load/voltage.
Contact material	Copper alloy
Contact surface material	Ag
Contact carrier material	PA
Standards/regulations	PA: Fire protection in rail vehicles - requirement sets R22 and R23 acc. to DIN EN 45545-2 (Risk level HL1 - HL2)
	PA: Fire protection in rail vehicles - requirement set R24 acc. to DIN EN 45545-2 (Risk level HL1 - HL3)
Degree of pollution	3
Overvoltage category	III
Flammability rating according to UL 94	V0
Assembly instructions	To ensure correct use, installation in housing with IP54 protection or better is required
Installation instructions	Connectors may be plugged in only when there is no load/voltage.

### Standards and Regulations

Connection in acc. with standard	CSA
Constructional and testing regulations	DIN EN 61984
	DIN EN 60664
	IEC 60352
Flammability rating according to UL 94	V0
Standards/regulations	acc. to DIN EN 45545-2

### Environmental Product Compliance

REACH SVHC	Lead 7439-92-1
China RoHS	Environmentally Friendly Use Period = 50 years
	For details about hazardous substances go to tab "Downloads", Category "Manufacturer's declaration"

## Drawings

# Terminal adapter - HC-B 16-A-DT-PER-M - 1648461

Dimensional drawing

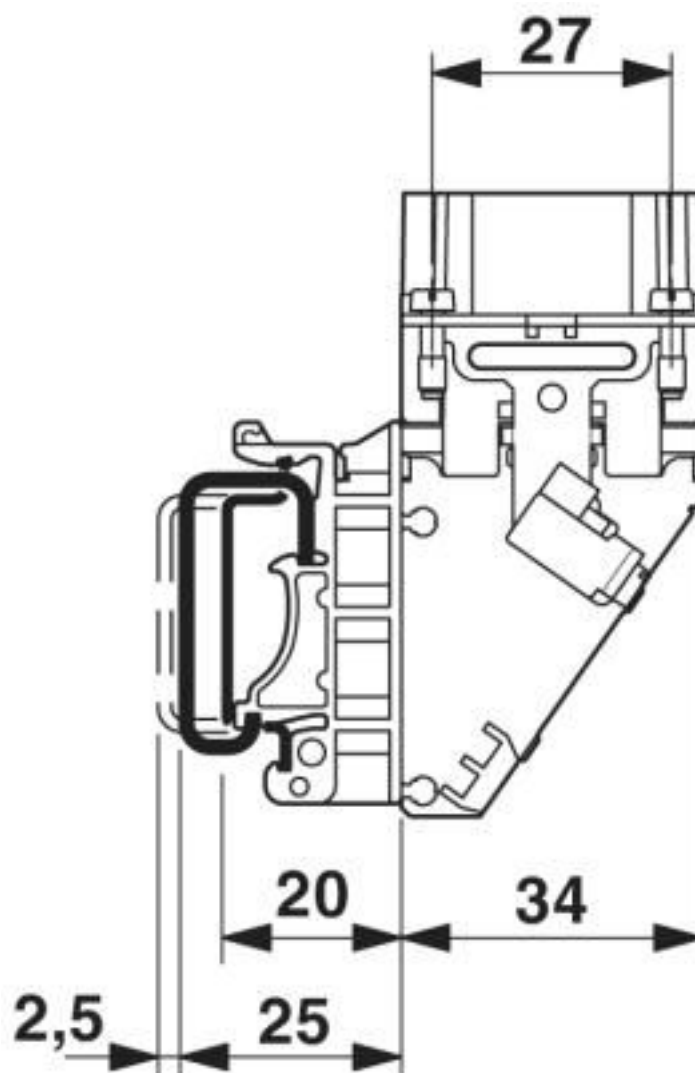

Dimensional drawing, side view

# Terminal adapter - HC-B 16-A-DT-PER-M - 1648461

Dimensional drawing

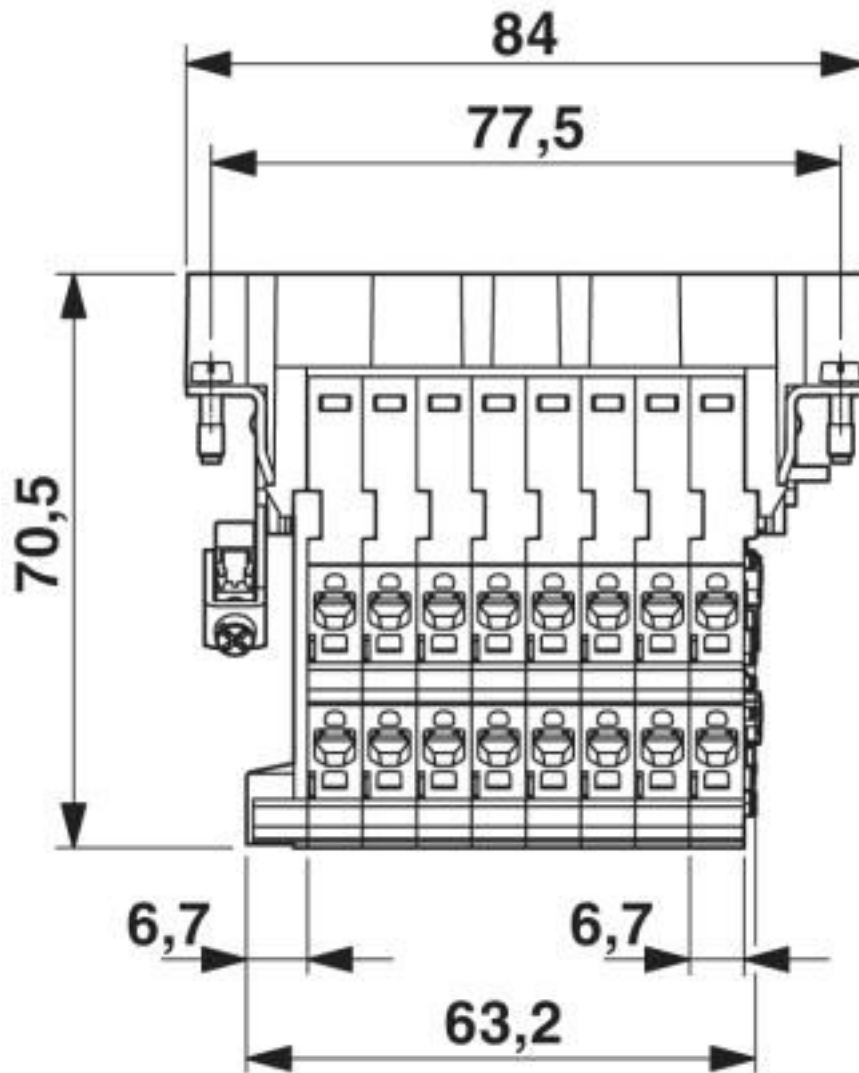

Dimensional drawing

# Terminal adapter - HC-B 16-A-DT-PER-M - 1648461

Dimensional drawing

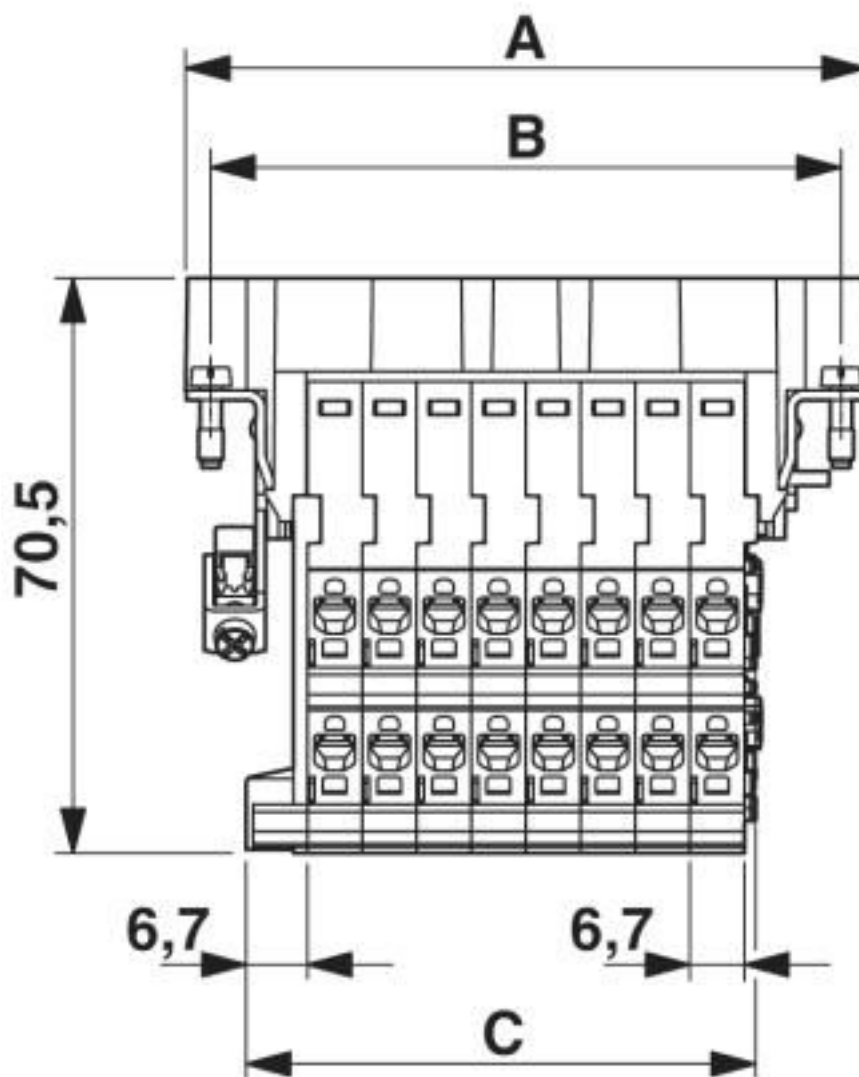

# Terminal adapter - HC-B 16-A-DT-PER-M - 1648461

Diagram

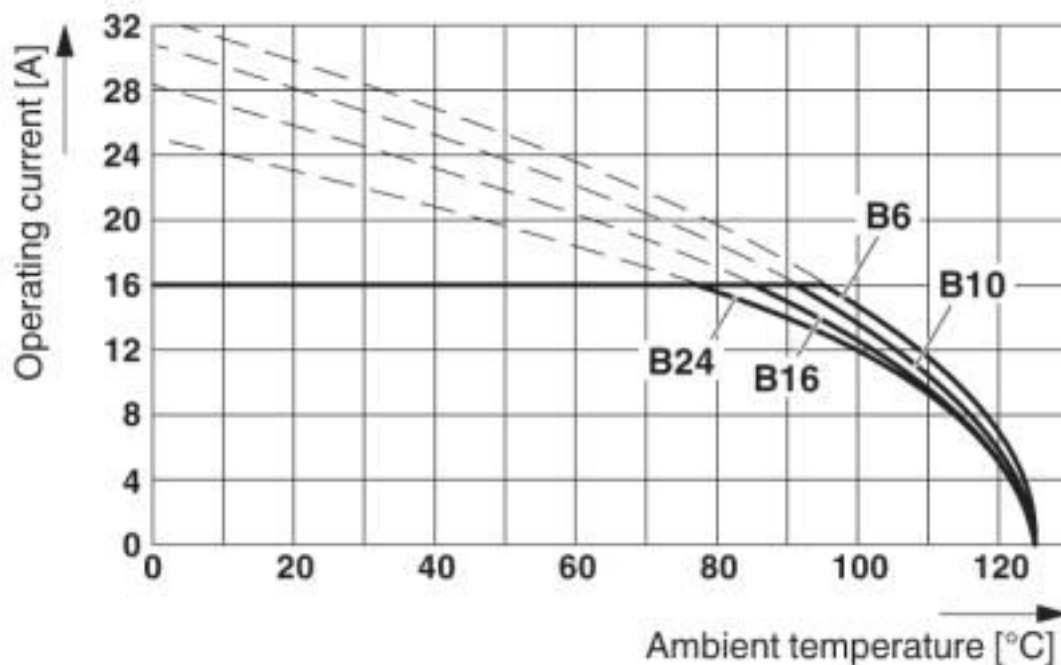

Derating diagram

## Classifications

### eCl@ss

eCl@ss 10.0.1	27440222
eCl@ss 4.0	27140800
eCl@ss 4.1	27140800
eCl@ss 5.0	27143400
eCl@ss 5.1	27261200
eCl@ss 6.0	27261200
eCl@ss 7.0	27440205
eCl@ss 8.0	27440205
eCl@ss 9.0	27440222

### ETIM

ETIM 3.0	EC000438
ETIM 4.0	EC000438
ETIM 5.0	EC000438
ETIM 6.0	EC000438
ETIM 7.0	EC000438

### UNSPSC

UNSPSC 6.01	30211923
-------------	----------

# Terminal adapter - HC-B 16-A-DT-PER-M - 1648461

## Classifications

### UNSPSC

UNSPSC 7.0901	39121522
UNSPSC 11	39121522
UNSPSC 12.01	39121522
UNSPSC 13.2	39121421
UNSPSC 18.0	39121522
UNSPSC 19.0	39121522
UNSPSC 20.0	39121522
UNSPSC 21.0	39121522

## Approvals

### Approvals

#### Approvals

CSA / UL Recognized / cUL Recognized / EAC / EAC / cULus Recognized

#### Ex Approvals

### Approval details

CSA		<a href="http://www.csagroup.org/services-industries/product-listing/">http://www.csagroup.org/services-industries/product-listing/</a>	013631_6233_01
Nominal voltage UN		600 V	
Nominal current IN		13 A	
mm <sup>2</sup> /AWG/kcmil		22-14	

UL Recognized		<a href="http://database.ul.com/cgi-bin/XYV/template/LISEXT/1FRAME/index.htm">http://database.ul.com/cgi-bin/XYV/template/LISEXT/1FRAME/index.htm</a>	FILE E 118976
Nominal voltage UN		600 V	
Nominal current IN		13 A	
mm <sup>2</sup> /AWG/kcmil		22-14	

# Terminal adapter - HC-B 16-A-DT-PER-M - 1648461

## Approvals

cUL Recognized		<a href="http://database.ul.com/cgi-bin/XYV/template/LISEXT/1FRAME/index.htm">http://database.ul.com/cgi-bin/XYV/template/LISEXT/1FRAME/index.htm</a>	FILE E 118976
Nominal voltage UN		600 V	
Nominal current IN		13 A	
mm <sup>2</sup> /AWG/kcmil		22-14	

EAC		RU C- DE.AI30.B.01102
-----	--	--------------------------

EAC		RU C- DE.BL08.B.00511
-----	--	--------------------------

cULus Recognized	
------------------	--

## Accessories

### Accessories

#### Coding element

Coding profile - CP-HC - 1686478



Coding profile, 4 coding profiles per strip, for insertion in coding keyways

Coding element - HC-CST - 1676857



Coding peg for coding up to 16 connectors



## Terminal adapter - HC-B 16-A-DT-PER-M - 1648461

### Accessories

Coding element - HC-CBU - 1676860



Coding socket for coding up to 16 connectors

---

Coding bolt - HC-CB - 1772722



Coding pin, prevents mismatching of up to six connectors with an identical number of positions

---

### Labeled terminal marker

Zack marker strips off the roll, flat - ZBF-U CUS - 0828525



Zack marker strips off the roll, flat, can be ordered: Strip, white, labeled according to customer specifications, mounting type: snap into flat marker groove, for terminal block width: 1000 mm, lettering field size: 5.15 x ... mm

---

### Mounting material

Foot element - HC-KA-FE - 1775240



Foot element, for mounting on DIN rail NS 32, DIN rail NS 35/7.5 or DIN rail NS 35/15, can be inserted between basic and side element

---

Locking screw barrel - HC-VSH - 1660083



Locking screw barrel, for a firm connection of contact inserts and DIN-rail mountable terminal adapters

---

# Terminal adapter - HC-B 16-A-DT-PER-M - 1648461

## Accessories

Screw - HC-B-PES - 1604997



PE screw, for contact inserts HC-B / HC-BB / HC-DD / HC-D40 / HC-D64

---

PE multiplier - HC-B-3PE - 1644326



PE multiplier, for three PE connections, for HC-B (besides HC-B..E..ZZ) / HC-BB / HC-DD / HC-D40 / HC-D64 contact inserts

---

## Screwdriver tools

Screwdriver - SZF 0-0,4X2,5 - 1204504



Actuation tool, for ST terminal blocks, also suitable for use as a bladed screwdriver, size: 0.4 x 2.5 x 75 mm, 2-component grip, with non-slip grip

---

## Additional products

Contact insert - HC-B16-I-PT-F - 1407731



HEAVYCON socket insert, B16 series, 16 + PE-pos., push-in connection

---

## X-ON Electronics

Largest Supplier of Electrical and Electronic Components

*Click to view similar products for [Heavy Duty Power Connectors](#) category:*

*Click to view products by [Phoenix Contact](#) manufacturer:*

Other Similar products are found below :

[647757-1](#) [6643411-1](#) [6646058-2](#) [6646137-1](#) [6646138-1](#) [6646479-1](#) [6646608-1](#) [6646786-1](#) [6646940-1](#) [6651091-1](#) [6651525-1](#) [6651529-1](#)  
[6651788-1](#) [696475-1](#) [702-32-01109](#) [703-25-02205](#) [73000005059](#) [73000005642](#) [73080255059](#) [73080965046](#) [765-15-0080A](#) [765-16-0080B](#)  
[765-18-0080D](#) [829992-1](#) [902-77-02113](#) [PS00/A0620/6300](#) [PS25/A0420/63](#) [129-1J](#) [1409400](#) [AN0024023](#) [E6374G1](#) [e6389g2](#) [157-43GW8](#)  
[MS3117-14AC](#) [1643543-1](#) [1650540-1](#) [1651811-2](#) [1766260-1](#) [1766282-1](#) [1766966-1](#) [1791340000](#) [NLDFT-3-BL-L-S120-M40A](#) [NLDFT-N-](#)  
[W-L-C240-M40B](#) [NLS-2-R-C240-M40B](#) [NLS-N-W-C240-M40B](#) [NPS-3-BL-T6](#) [1986615-1](#) [2-1589900-8](#) [2199314-1](#) [KA8102](#)