

Patch cable - VS-04-2X2X26C7/7-SDA/SDB/1,0 - 1654853

Please be informed that the data shown in this PDF Document is generated from our Online Catalog. Please find the complete data in the user's documentation. Our General Terms of Use for Downloads are valid (<http://phoenixcontact.com/download>)



Assembled USB cable, shielded, color: RAL 5021 (water blue), PUR outer sheath, USB type A/standard on USB type B/standard, length: 1 m



Key Commercial Data

Packing unit	1 pc
GTIN	
GTIN	4017918984199

Technical data

Environmental Product Compliance

China RoHS	Environmentally friendly use period: unlimited = EFUP-e
	No hazardous substances above threshold values

Drawings

Patch cable - VS-04-2X2X26C7/7-SDA/SDB/1,0 - 1654853

Dimensional drawing

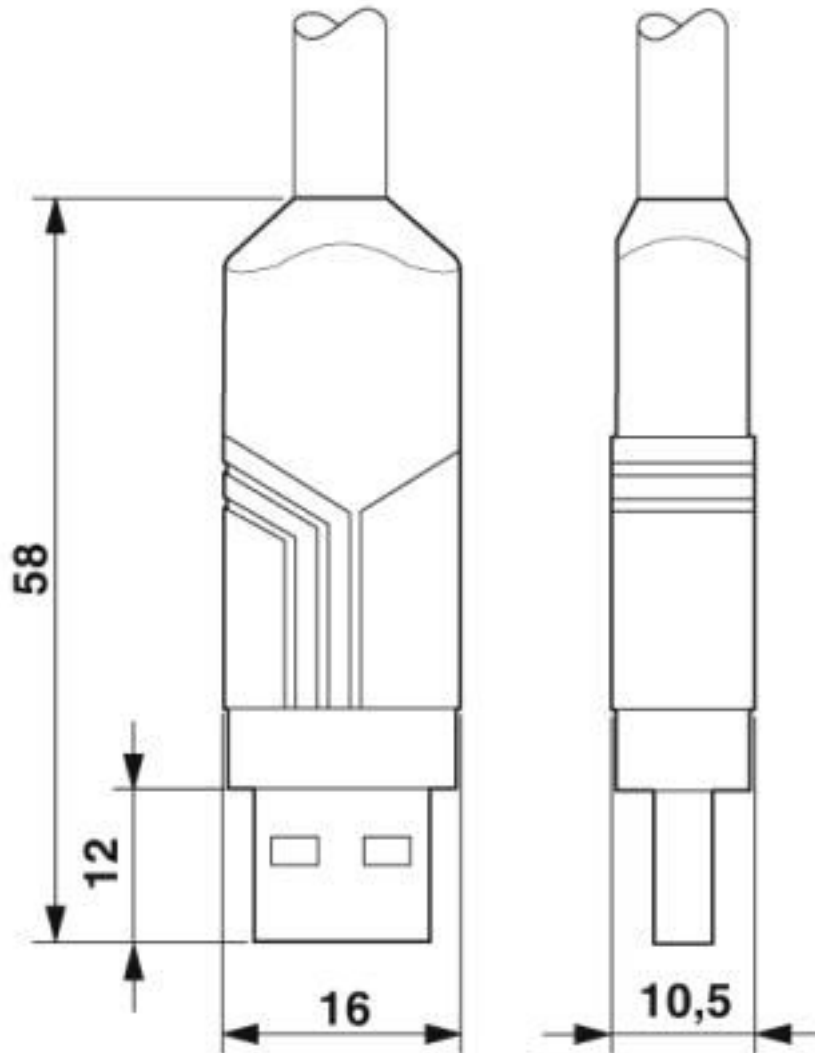

USB connector, type A, Standard

Patch cable - VS-04-2X2X26C7/7-SDA/SDB/1,0 - 1654853

Dimensional drawing

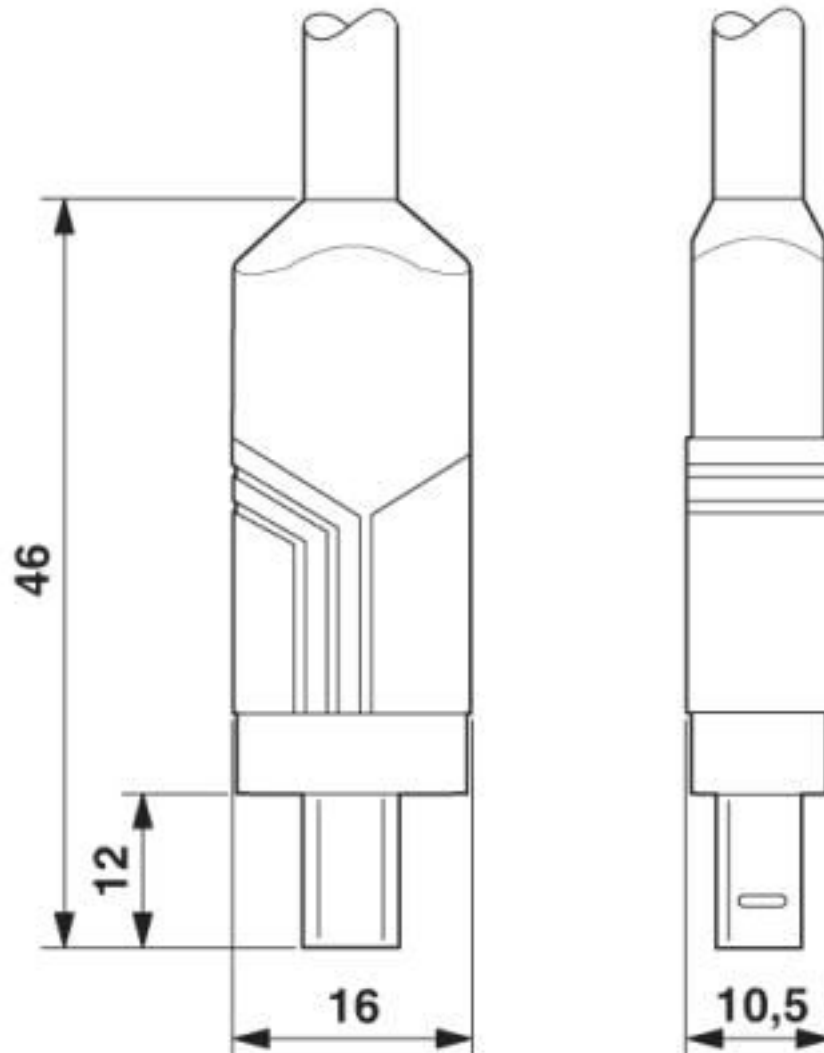

USB connector, type B, standard

Patch cable - VS-04-2X2X26C7/7-SDA/SDB/1,0 - 1654853

Circuit diagram

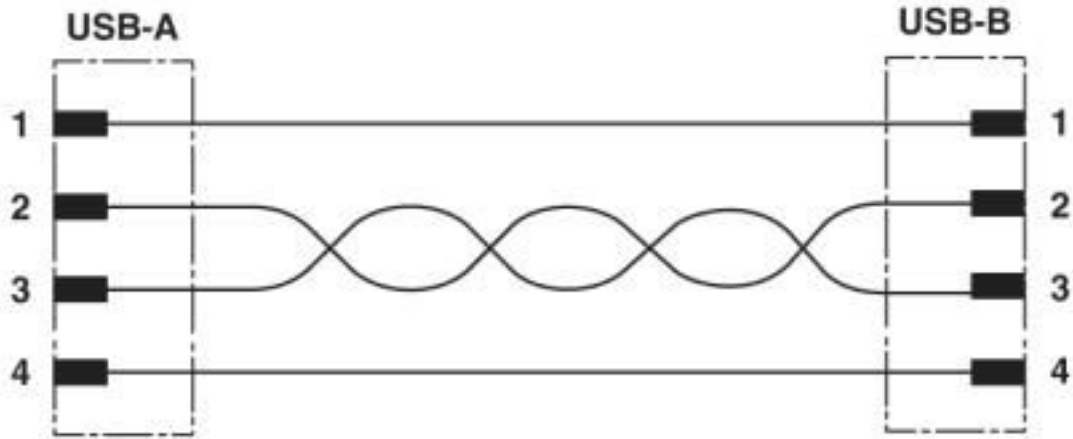

Schematic diagram

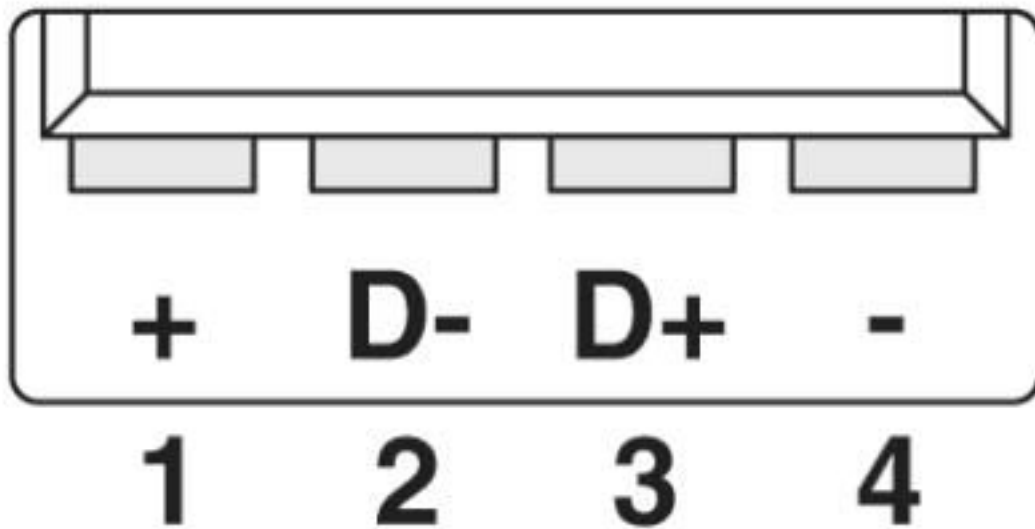

Pin assignment plug USB, type A

Patch cable - VS-04-2X2X26C7/7-SDA/SDB/1,0 - 1654853

Schematic diagram

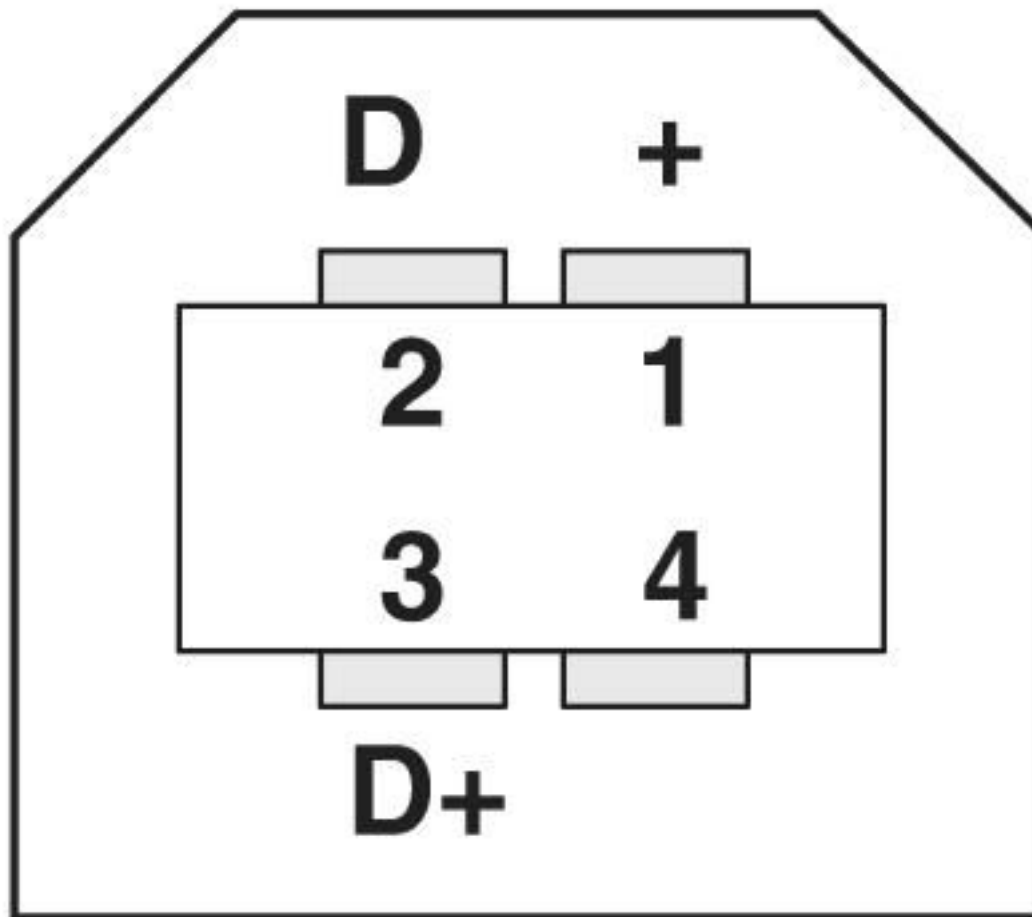

Plug pin assignment plug USB, type B

Classifications

eCl@ss

eCl@ss 10.0.1	27060390
eCl@ss 4.0	24010400
eCl@ss 4.1	24010400
eCl@ss 5.0	19030300
eCl@ss 5.1	19030300
eCl@ss 6.0	27060300
eCl@ss 7.0	27060390
eCl@ss 8.0	27060390
eCl@ss 9.0	27060390

ETIM

ETIM 2.0	EC000830
----------	----------

Patch cable - VS-04-2X2X26C7/7-SDA/SDB/1,0 - 1654853

Classifications

ETIM

ETIM 3.0	EC001855
ETIM 4.0	EC001855
ETIM 5.0	EC001408
ETIM 6.0	EC000748
ETIM 7.0	EC000748

UNSPSC

UNSPSC 6.01	31261501
UNSPSC 7.0901	31261501
UNSPSC 11	31261501
UNSPSC 12.01	31261501
UNSPSC 13.2	26121604
UNSPSC 18.0	26121604
UNSPSC 19.0	26121604
UNSPSC 20.0	26121604
UNSPSC 21.0	26121604

Approvals

Approvals

Approvals

EAC

Ex Approvals

Approval details

EAC		19060508
-----	---	----------

Phoenix Contact 2020 © - all rights reserved
<http://www.phoenixcontact.com>

PHOENIX CONTACT GmbH & Co. KG
Flachsmarktstr. 8
32825 Blomberg
Germany
Tel. +49 5235 300
Fax +49 5235 3 41200
<http://www.phoenixcontact.com>

X-ON Electronics

Largest Supplier of Electrical and Electronic Components

Click to view similar products for [USB Cables / IEEE 1394 Cables](#) category:

Click to view products by [Phoenix Contact](#) manufacturer:

Other Similar products are found below :

[68768-0173](#) [FNY-W6003-01](#) [88764-0800](#) [148700-1](#) [17-200621](#) [17-250051P](#) [954](#) [17-200261](#) [AC102012-1](#) [AC102012-2](#) [FTP-629Y601](#) [45-1345-15](#) [45-1358-15](#) [45-1363-15](#) [IP-USB1\(C10\)S-RW](#) [CABLE/RTP/USB/DT](#) [45-1351-15](#) [45-1357-15](#) [45-1433-1](#) [687680278](#)
[USBFTVX2SA2N03A](#) [USBFTV2SA2N03A](#) [USBFTV2SA2N05A](#) [FTP-629Y401](#) [FTP-628Y302](#) [FTP-628Y402](#) [CSMNB9MF-5](#) [FNY-W6022](#) [UA-30AMF-SD7B03](#) [UA-30AMFM-SL7B03](#) [USBAPSCC7202A](#) [17-200641](#) [UES-1001A160](#) [UES-1003A160](#)
[USBFTVX7SA2N20A](#) [USBFTV2PEMSA2N10A](#) [FTP-629Y602](#) [USBCAMCM100](#) [USB A/F*2 to 2.54 2*5P-SH L=400mm](#) [68784-0075](#)
[MINI-SCREW-USB-DATACABLE](#) [USB-29](#) [19800-010500-200-RS](#) [103-1092-BL-F0050](#) [103-1020-BL-00100](#) [103-1092-BL-F0200](#) [103-1092-BL-F0100](#) [105-1092-BL-00300](#) [105-1092-BL-00200](#) [105-1031-BL-00200](#)